

### FEATURES

- Constant low  $R_{DS(on)}$  of 40 m $\Omega$  over input voltage range
- Low input voltage range: 0.9 V to 3.6 V
- 500 mA continuous operating current at 85°C
- 1.2 V logic compatible enable input
- Low 6  $\mu$ A quiescent current, independent of load current
- Ultralow shutdown current: <100 nA
- Ultrasmall 0.8 mm  $\times$  0.8 mm  $\times$  0.5 mm, 4-ball, 0.4 mm pitch WLCSP

### APPLICATIONS

- Low operating voltage processors
- Mobile phones
- Digital cameras and audio devices
- Portable and battery-powered equipment
- Optical XMT/RCVR modules

### GENERAL DESCRIPTION

The ADP199 is a high-side load switch designed for operation between 0.9 V to 3.6 V. A load switch provides power domain isolation, thereby helping to keep subsystems isolated and powered independently, and enabling reduced power consumption.

The ADP199 contains a low on-resistance, N-channel MOSFET to minimize power loss, and supports over 500 mA of continuous load current. The low 6  $\mu$ A quiescent current and ultralow shutdown current make the ADP199 ideal for battery-operated portable equipment. The built-in level shifter for enable logic makes the ADP199 compatible with many processors and GPIO controllers.

In addition to high performance, the ADP199 occupies minimal printed circuit board (PCB) space with an area of less than 0.64 mm<sup>2</sup> and a height of 0.50 mm.

The ADP199 is available in an ultra-small, 0.8 mm  $\times$  0.8 mm  $\times$  0.5 mm, 4-ball, 0.4 mm pitch WLCSP.

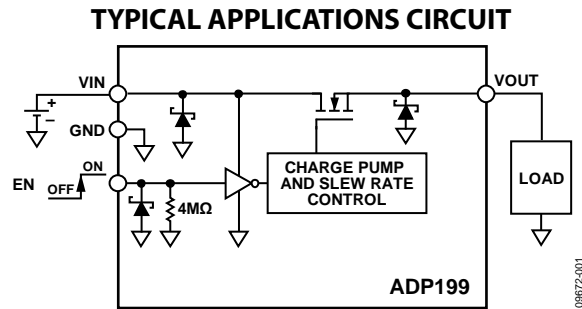

Figure 1.

#### Rev. A

Information furnished by Analog Devices is believed to be accurate and reliable. However, no responsibility is assumed by Analog Devices for its use, nor for any infringements of patents or other rights of third parties that may result from its use. Specifications subject to change without notice. No license is granted by implication or otherwise under any patent or patent rights of Analog Devices. Trademarks and registered trademarks are the property of their respective owners.

**TABLE OF CONTENTS**

Features .....	1	Typical Performance Characteristics .....	6
Applications.....	1	Theory of Operation .....	11
General Description .....	1	Applications Information .....	12
Typical Applications Circuit.....	1	Ground Current.....	12
Revision History .....	2	Enable Feature .....	12
Specifications.....	3	Timing.....	12
Timing Diagram .....	3	Outline Dimensions .....	14
Absolute Maximum Ratings.....	4	Ordering Guide .....	14
ESD Caution.....	4		
Pin Configuration and Function Descriptions.....	5		

**REVISION HISTORY**

**7/12—Rev. 0 to Rev. A**

Change to Figure 1 .....	1
Change to Figure 13 .....	7
Change to Figure 29 .....	11

**11/11—Revision 0: Initial Version**

# SPECIFICATIONS

$V_{IN} = 1.8\text{ V}$ ,  $V_{EN} = V_{IN}$ ,  $I_{OUT} = 200\text{ mA}$ ,  $T_A = 25^\circ\text{C}$ , unless otherwise noted.

Table 1.

Parameter	Symbol	Test Conditions/Comments	Min	Typ	Max	Unit
INPUT VOLTAGE RANGE	$V_{IN}$	$T_J = -40^\circ\text{C}$ to $+85^\circ\text{C}$	0.9		3.6	V
EN INPUT						
EN Input Threshold	$V_{IH}$	% of $V_{IN}$ , $V_{IN} = 0.9\text{ V}$ to $3.6\text{ V}$ , $T_J = -40^\circ\text{C}$ to $+85^\circ\text{C}$	65			%
EN Input Pull-Down Current	$I_{EN}$	% of $V_{IN}$ , $V_{IN} = 0.9\text{ V}$ to $3.6\text{ V}$ , $T_J = -40^\circ\text{C}$ to $+85^\circ\text{C}$ $V_{IN} = 1.8\text{ V}$		450	25	nA
CURRENT						
Ground Current	$I_{GND}$	$V_{IN} = 0.9\text{ V}$ $V_{IN} = 1.2\text{ V}$ $V_{IN} = 1.8\text{ V}$ , $T_J = -40^\circ\text{C}$ to $+85^\circ\text{C}$ $V_{IN} = 3.6\text{ V}$		3 4 6 35	20	$\mu\text{A}$ $\mu\text{A}$ $\mu\text{A}$ $\mu\text{A}$
Off State Current	$I_{OFF-IN}$	$V_{EN} = \text{GND}$ , $V_{OUT} = 0\text{ V}$ $V_{EN} = 0\text{ V}$ , $V_{IN} = 3.6\text{ V}$ , $V_{OUT} = 0\text{ V}$ $V_{EN} = \text{GND}$ , $T_J = -40^\circ\text{C}$ to $+85^\circ\text{C}$ , $V_{OUT} = 0\text{ V}$		90 165		nA nA
Continuous Operating Current	$I_{OUT}$	$V_{IN} = 0.9\text{ V}$ to $3.6\text{ V}$ , $T_J = -40^\circ\text{C}$ to $+85^\circ\text{C}$		500	3	$\mu\text{A}$ mA
$V_{IN}$ to $V_{OUT}$ RESISTANCE	$R_{DS(ON)}$	$V_{IN} = 0.9\text{ V}$ $V_{IN} = 1.2\text{ V}$ $V_{IN} = 1.8\text{ V}$ , $T_J = -40^\circ\text{C}$ to $+85^\circ\text{C}$ $V_{IN} = 3.6\text{ V}$		0.04 0.04 0.04 0.04	0.09	$\Omega$ $\Omega$ $\Omega$ $\Omega$
$V_{OUT}$ TURN-ON DELAY TIME		See Figure 2				
Turn-On Delay Time	$t_{ON\_DLY}$	$V_{IN} = 1.8\text{ V}$ , $C_{LOAD} = 4.7\text{ }\mu\text{F}$		20		$\mu\text{s}$
$V_{OUT}$ TURN-OFF DELAY TIME		See Figure 2				
Turn-Off Delay Time	$t_{OFF\_DLY}$	$V_{IN} = 1.8\text{ V}$ , $I_{LOAD} = 10\text{ mA}$ , $C_{LOAD} = 4.7\text{ }\mu\text{F}$		60		$\mu\text{s}$

## TIMING DIAGRAM

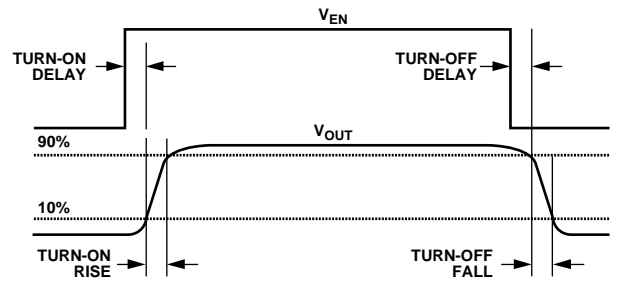

Figure 2. Timing Diagram

## ABSOLUTE MAXIMUM RATINGS

Table 2.

Parameter	Rating
VIN to GND	−0.3 V to +4.0 V
VOU to GND	−0.3 V to $V_{IN}$
EN to GND	−0.3 V to +4.0 V
Continuous Drain Current	
$T_A = 25^\circ\text{C}$	±1000 mA
$T_A = 85^\circ\text{C}$	±700 mA
Continuous Diode Current	−50 mA
Storage Temperature Range	−65°C to +150°C
Operating Junction Temperature Range	−40°C to +85°C
Soldering Conditions	JEDEC J-STD-020

Stresses above those listed under Absolute Maximum Ratings may cause permanent damage to the device. This is a stress rating only; functional operation of the device at these or any other conditions above those indicated in the operational section of this specification is not implied. Exposure to absolute maximum rating conditions for extended periods may affect device reliability.

Table 3. Typical  $\theta_{JA}$  and  $\Psi_{JB}$  Values

Package Type	$\theta_{JA}$	$\Psi_{JB}$	Unit
4-Ball, 0.4 mm Pitch WLCSP	260	58	°C/W

### ESD CAUTION



**ESD (electrostatic discharge) sensitive device.** Charged devices and circuit boards can discharge without detection. Although this product features patented or proprietary protection circuitry, damage may occur on devices subjected to high energy ESD. Therefore, proper ESD precautions should be taken to avoid performance degradation or loss of functionality.

## PIN CONFIGURATION AND FUNCTION DESCRIPTIONS

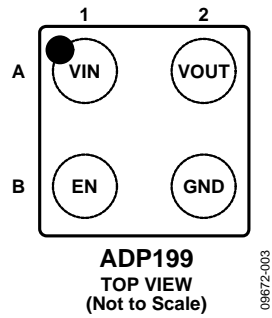

Figure 3. Pin Configuration

Table 4. Pin Function Descriptions

Pin No.	Mnemonic	Description
A1	VIN	Input Voltage.
A2	VOUT	Output Voltage.
B1	EN	Enable Input. Drive EN high to turn the switch on and drive EN low to turn the switch off.
B2	GND	Ground.

# TYPICAL PERFORMANCE CHARACTERISTICS

$V_{IN} = 1.2\text{ V}$ ,  $V_{EN} = V_{IN}$ ,  $C_{IN} = C_{OUT} = 1\ \mu\text{F}$ ,  $T_A = 25^\circ\text{C}$ , unless otherwise noted.

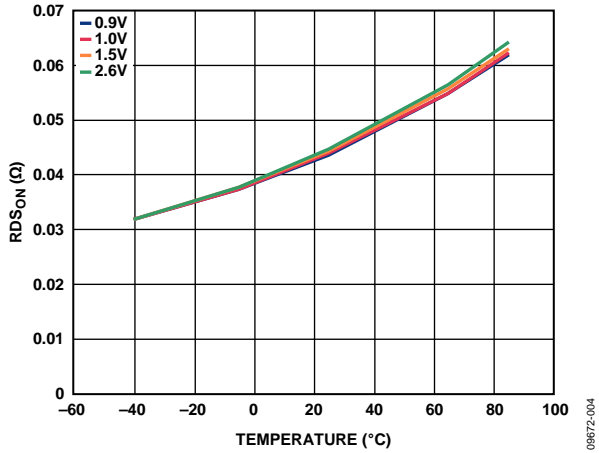

Figure 4.  $R_{DS\text{ON}}$  vs. Temperature, 50 mA, Different Input Voltage ( $V_{IN}$ )

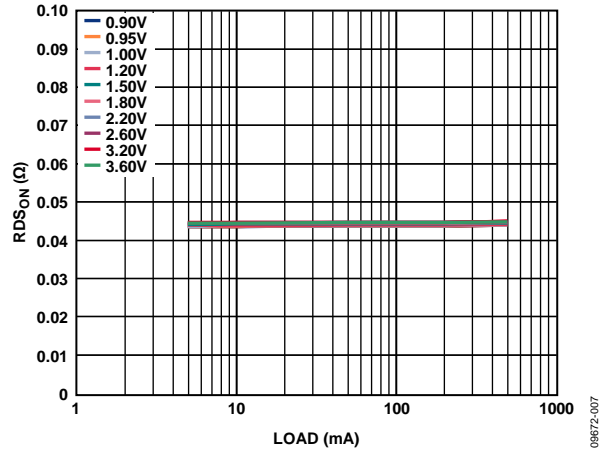

Figure 7.  $R_{DS\text{ON}}$  vs. Load Current, Different Input Voltage ( $V_{IN}$ )

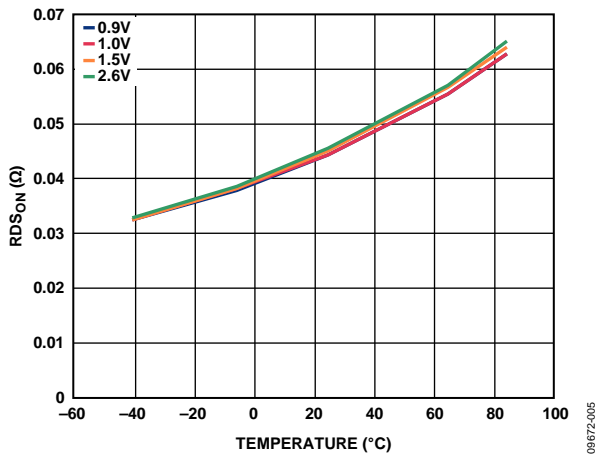

Figure 5.  $R_{DS\text{ON}}$  vs. Temperature, 500 mA, Different Input Voltage ( $V_{IN}$ )

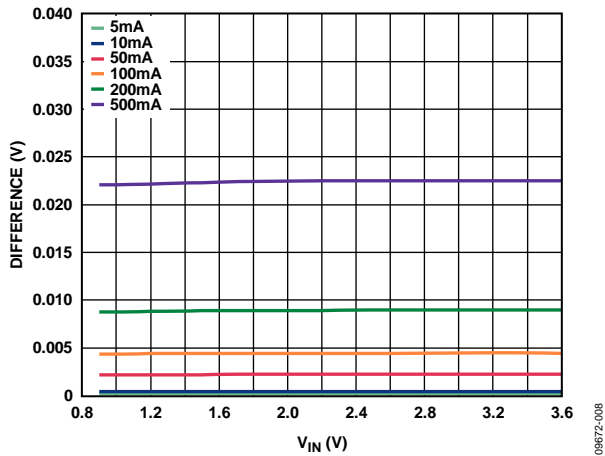

Figure 8. Voltage Drop vs. Temperature, Different Load Currents

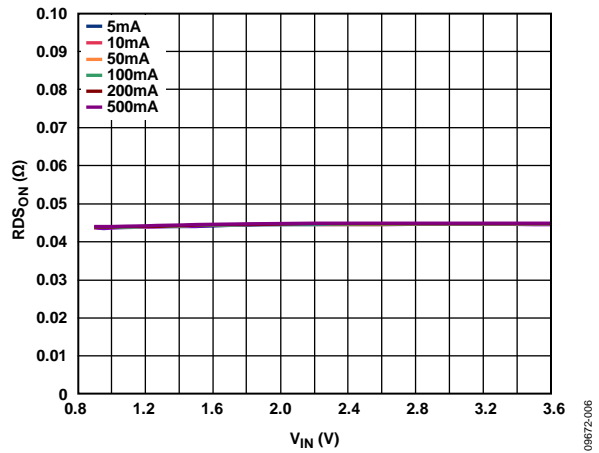

Figure 6.  $R_{DS\text{ON}}$  vs. Input Voltage ( $V_{IN}$ ), Different Load Currents

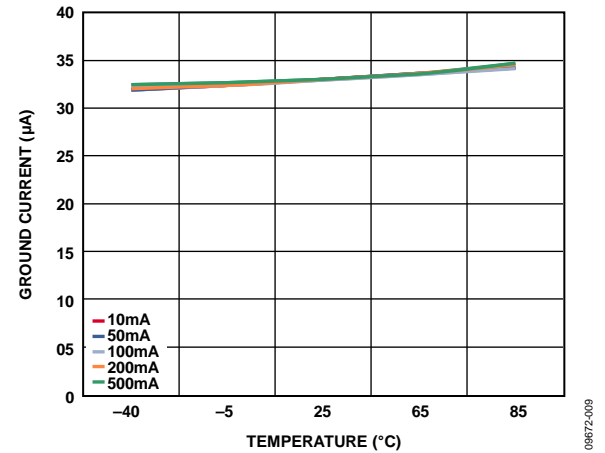

Figure 9. Ground Current vs. Temperature, Different Load Currents,  $V_{IN} = 0.9\text{ V}$

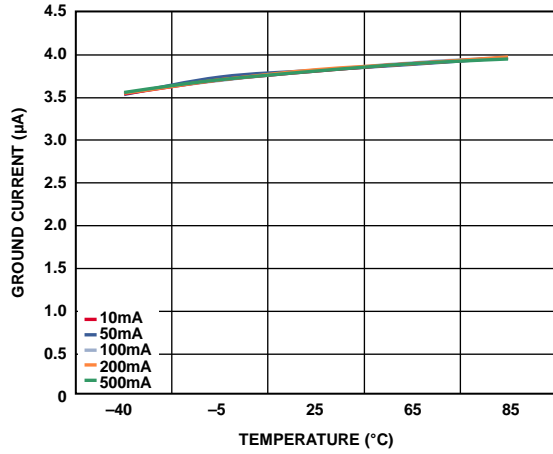

Figure 10. Ground Current vs. Temperature, Different Load Currents,  $V_{IN} = 1.2 V$

09672-010

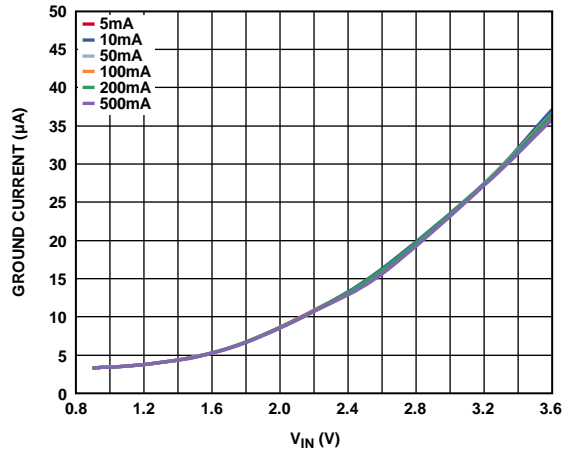

Figure 13. Ground Current vs. Input Voltage, Different Load Current

09672-013

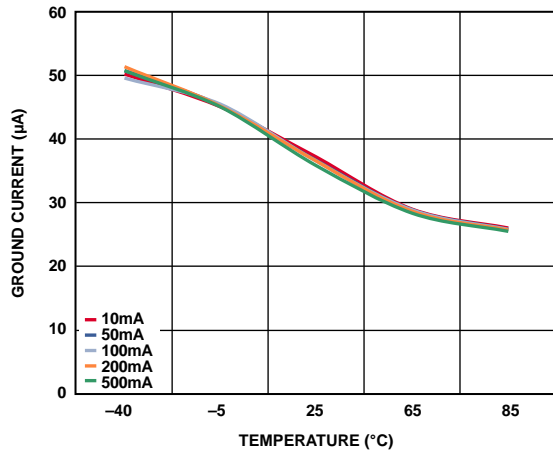

Figure 11. Ground Current vs. Temperature, Different Load Currents,  $V_{IN} = 3.6 V$

09672-011

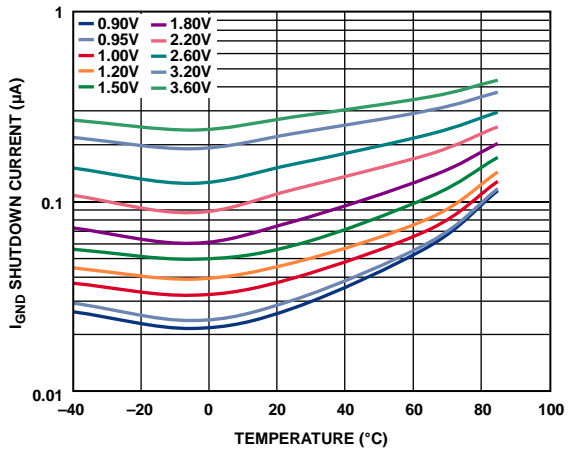

Figure 14. Ground Shutdown Current vs. Temperature, Output Open, Different Input Voltage ( $V_{IN}$ )

09672-014

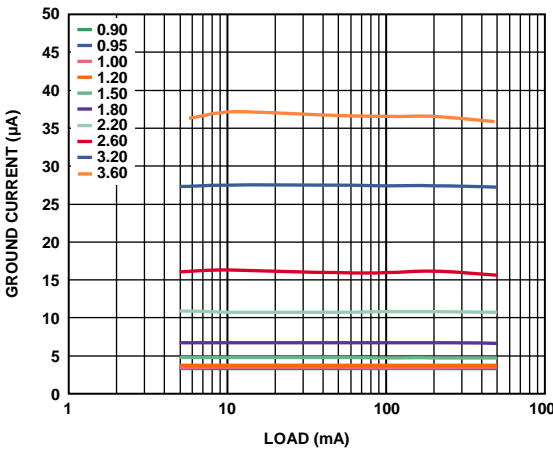

Figure 12. Ground Current vs. Load Current, Different Input Voltage ( $V_{IN}$ )

09672-012

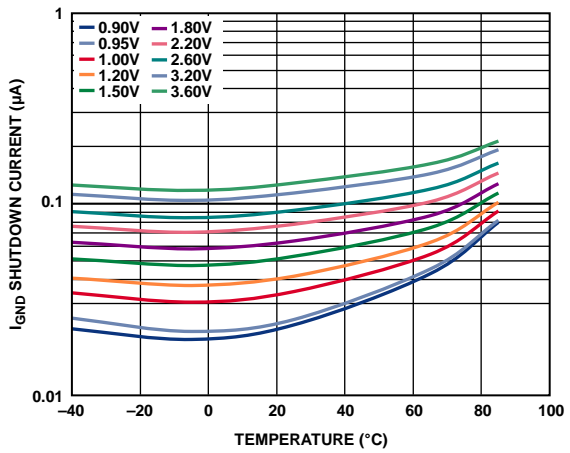

Figure 15. Ground Shutdown Current vs. Temperature,  $V_{OUT} = 0 V$ , Different Input Voltage ( $V_{IN}$ )

09672-015

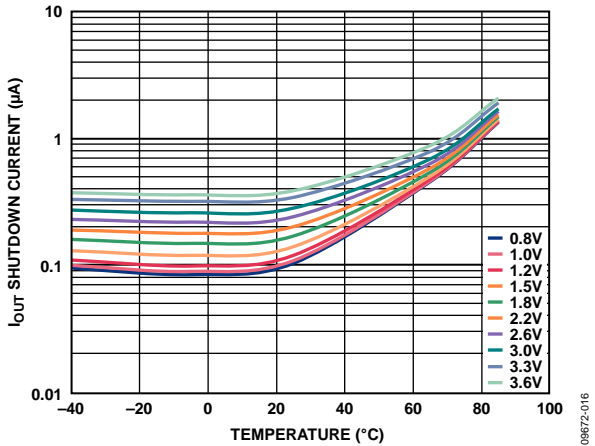

Figure 16. Output Shutdown Current vs. Temperature,  $V_{OUT} = 0V$ , Different Input Voltage ( $V_{IN}$ )

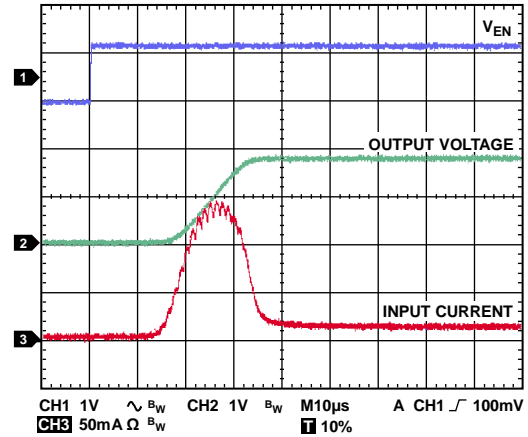

Figure 19. Typical Turn-On Time and Inrush Current,  $V_{IN} = 1.8V$ , 10 mA Load,  $C_{OUT} = 1\mu F$

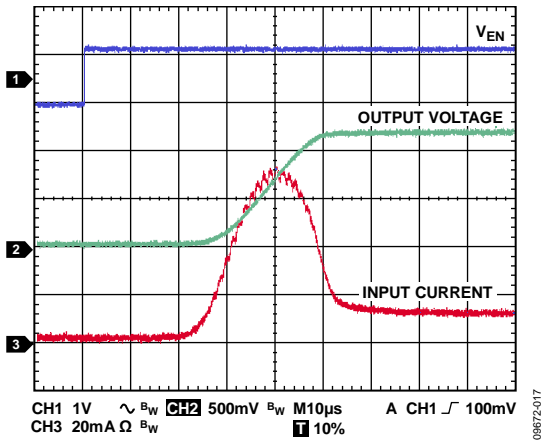

Figure 17. Typical Turn-On Time and Inrush Current,  $V_{IN} = 1.2V$ , 10 mA Load,  $C_{OUT} = 1\mu F$

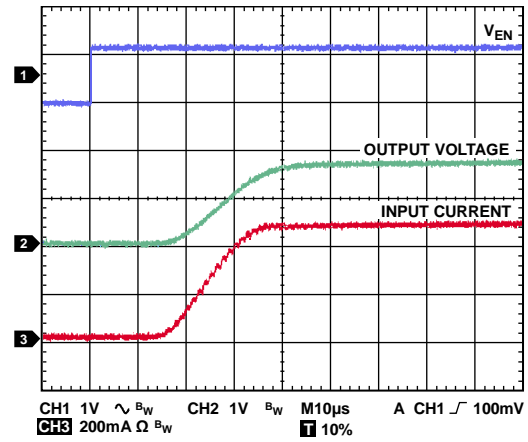

Figure 20. Typical Turn-On Time and Inrush Current,  $V_{IN} = 1.8V$ , 500 mA Load,  $C_{OUT} = 1\mu F$

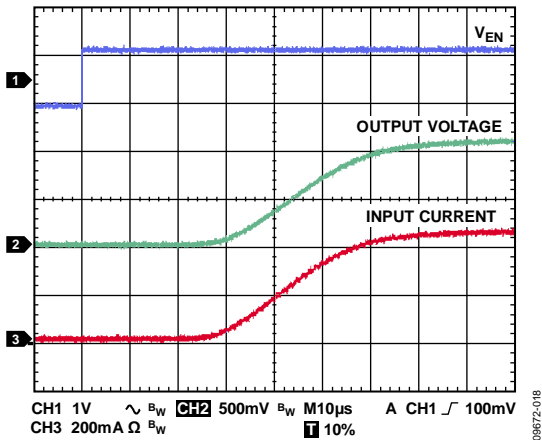

Figure 18. Typical Turn-On Time and Inrush Current,  $V_{IN} = 1.2V$ , 500 mA Load,  $C_{OUT} = 1\mu F$

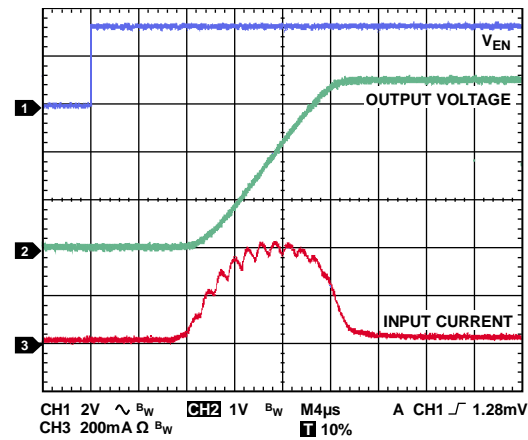

Figure 21. Typical Turn-On Time and Inrush Current,  $V_{IN} = 3.6V$ , 10 mA Load,  $C_{OUT} = 1\mu F$



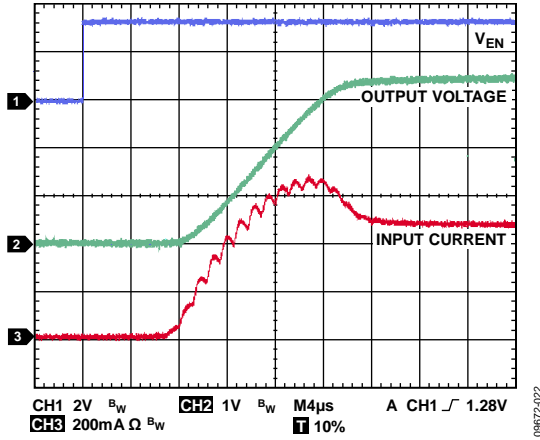

Figure 22. Typical Turn-On Time and Inrush Current,  $V_{IN} = 3.6V$ , 500 mA Load,  $C_{OUT} = 1\mu F$

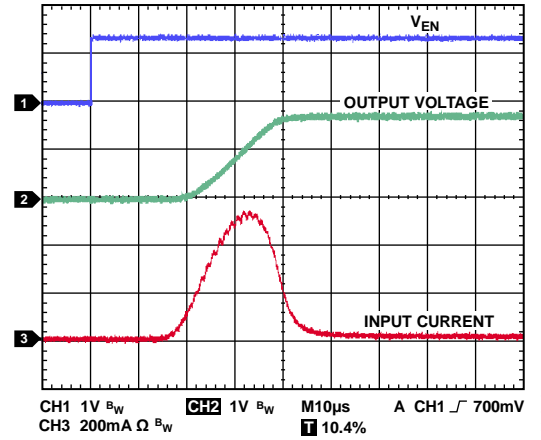

Figure 25. Typical Turn-On Time and Inrush Current,  $V_{IN} = 1.8V$ , 10 mA Load,  $C_{OUT} = 4.7\mu F$

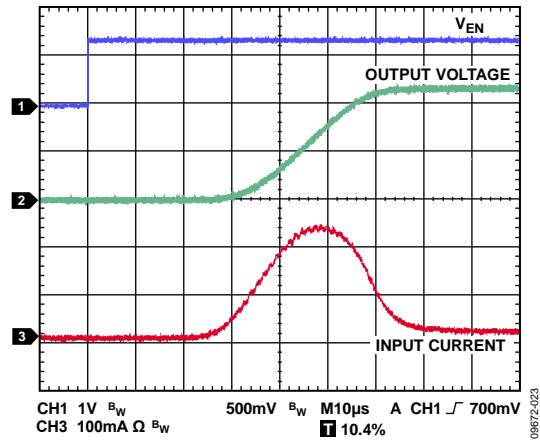

Figure 23. Typical Turn-On Time and Inrush Current,  $V_{IN} = 1.2V$ , 10 mA Load,  $C_{OUT} = 4.7\mu F$

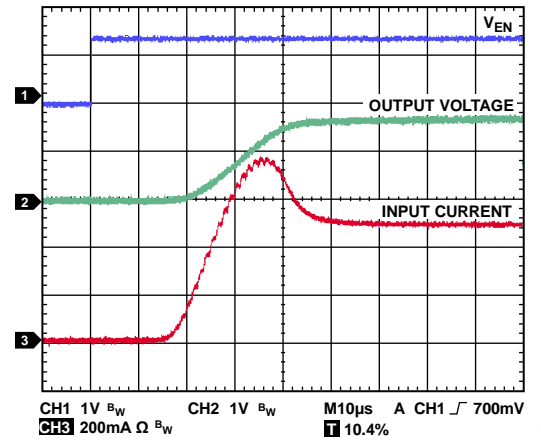

Figure 26. Typical Turn-On Time and Inrush Current,  $V_{IN} = 1.8V$ , 500 mA Load,  $C_{OUT} = 4.7\mu F$

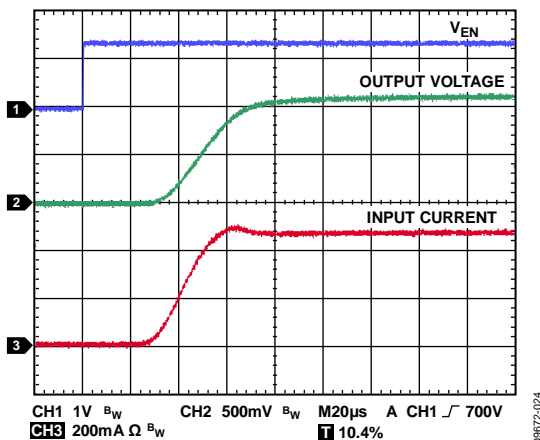

Figure 24. Typical Turn-On Time and Inrush Current,  $V_{IN} = 1.2V$ , 500 mA Load,  $C_{OUT} = 4.7\mu F$

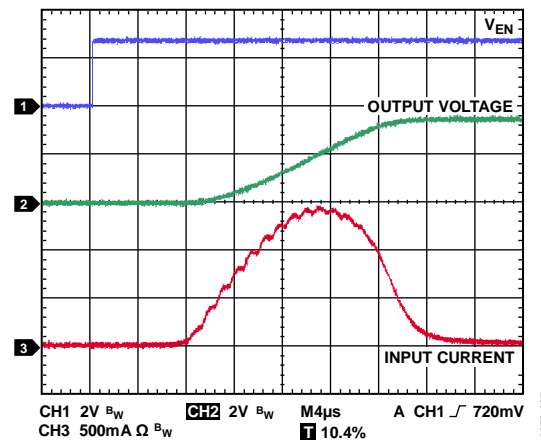

Figure 27. Typical Turn-On Time and Inrush Current,  $V_{IN} = 3.6V$ , 10 mA Load,  $C_{OUT} = 4.7\mu F$

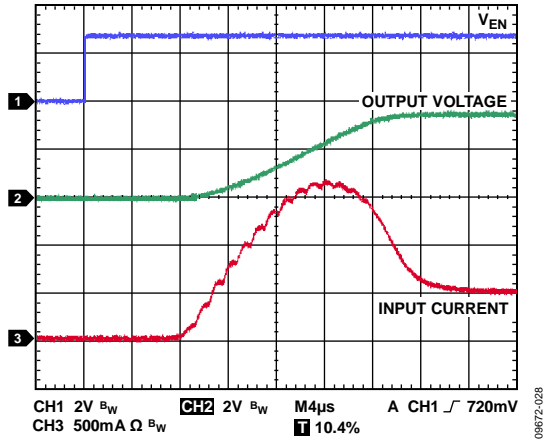

Figure 28. Typical Turn-On Time and Inrush Current,  
 $V_{IN} = 3.6V$ , 500 mA Load,  $C_{OUT} = 4.7 \mu F$

## THEORY OF OPERATION

The ADP199 is a high-side NMOS load switch controlled by an internal charge pump. The ADP199 is designed to operate with power supply voltages between 0.9 V and 3.6 V.

An internal charge pump biases the NMOS switch to achieve a relatively constant, ultralow on resistance of 40 m $\Omega$  across the entire input voltage range. The use of the internal charge pump also allows for controlled turn-on times. The switch is controlled on/off by the enable (EN) input and is capable of interfacing directly with 1.2 V logic signals.

The ADP199 is capable of 500 mA of continuous load current as long as  $T_j$  is less than 85°C.

ESD protection structures are shown in the block diagram (see Figure 29) as Zener diodes.

The ADP199 is a low quiescent current device with a nominal 4 M $\Omega$  pull-down resistor on its enable pin (EN). The package is a space-saving 0.8 mm  $\times$  0.8 mm, 4-ball WLCSP.

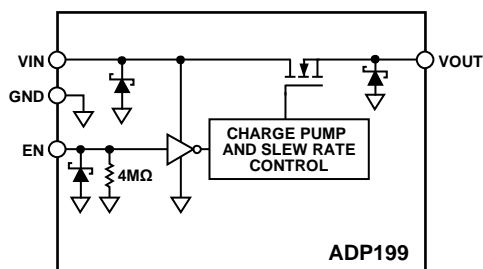

Figure 29. Functional Block Diagram

## APPLICATIONS INFORMATION

### GROUND CURRENT

The major source for ground current in the ADP199 is the internal charge pump for the FET drive circuitry. Figure 30 shows the typical ground current when  $V_{EN} = V_{IN}$ , and varies from 1.1 V to 3.6 V.

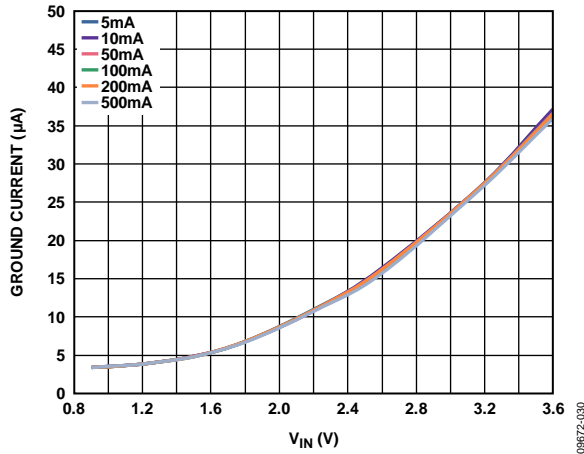

Figure 30. Ground Current vs. Input Voltage, Different Load Current

### ENABLE FEATURE

The ADP199 uses the EN input to enable and disable the  $V_{OUT}$  output. As shown in Figure 31, when a rising voltage ( $V_{EN}$ ) on the EN pin crosses the active threshold,  $V_{OUT}$  turns on. When a falling voltage ( $V_{EN}$ ) on the EN pin crosses the inactive threshold,  $V_{OUT}$  turns off.

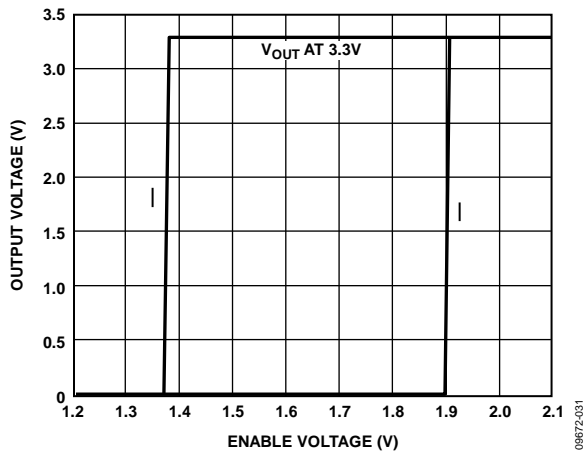

Figure 31. Typical EN Operation,  $V_{IN} = 3.3$  V

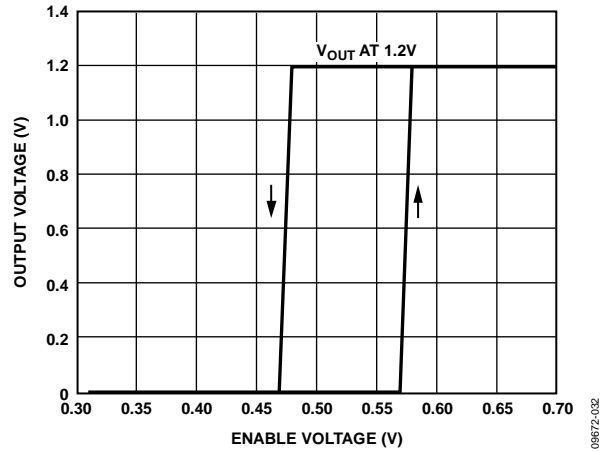

Figure 32. Typical EN Operation,  $V_{IN} = 1.2$  V

As shown in Figure 31, the EN pin has hysteresis built into it. This prevents on/off oscillations that can occur due to noise on the EN pin as it passes through the threshold points.

The EN pin active/inactive thresholds derive from the  $V_{IN}$  voltage; therefore, these thresholds vary with the changing input voltage. Figure 33 shows the typical EN active/inactive thresholds when the input voltage varies from 1.1 V to 3.6 V.

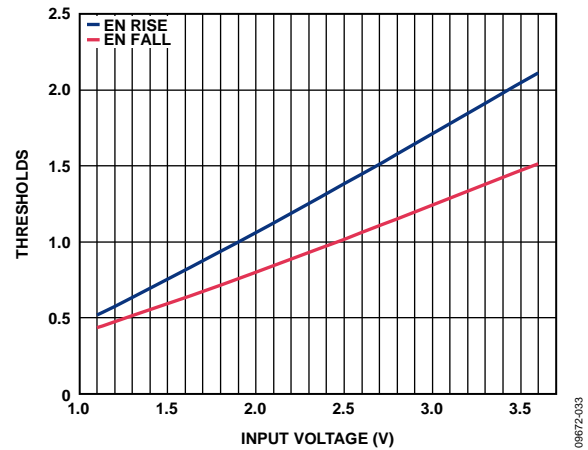

Figure 33. Typical EN Thresholds vs. Input Voltage ( $V_{IN}$ )

### TIMING

Turn-on delay is defined as the interval between the time that  $V_{EN}$  exceeds the rising threshold voltage and when  $V_{OUT}$  rises to  $\sim 10\%$  of its final value. The ADP199 includes circuitry that has a typical 1 ms turn-on delay, and a controlled rise time to limit the  $V_{IN}$  inrush current. As shown in Figure 34 and Figure 35, the turn-on delay is nearly independent of the input voltage.

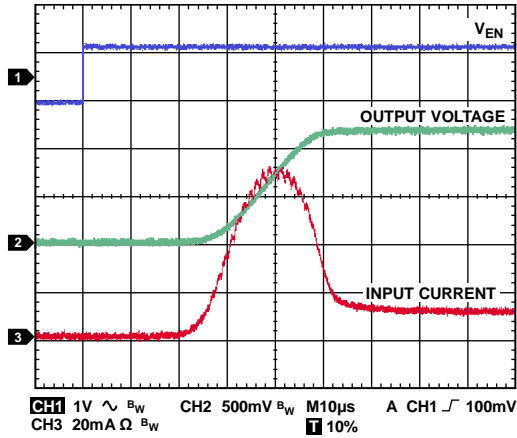

Figure 34. Typical Turn-On Delay Time with  $V_{IN} = 1.2\text{ V}$ ,  $I_{LOAD} = 10\text{ mA}$ ,  $C_{LOAD} = 1\text{ }\mu\text{F}$

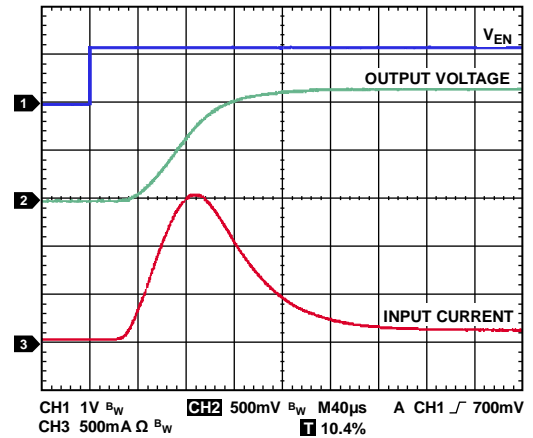

Figure 36. Typical Rise Time and Inrush Current,  $C_{LOAD} = 100\text{ }\mu\text{F}$ ,  $V_{IN} = 1.2\text{ V}$ ,  $I_{LOAD} = 100\text{ mA}$

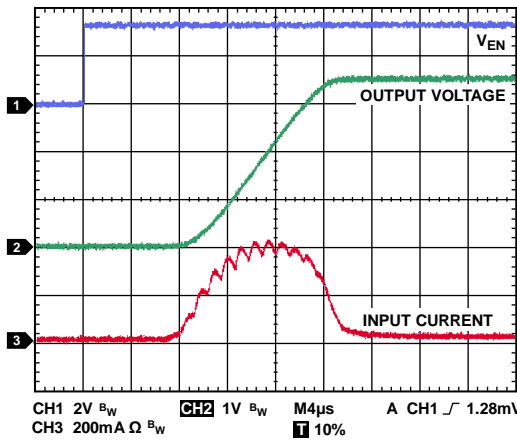

Figure 35. Typical Turn-On Delay Time with  $V_{IN} = 3.6\text{ V}$ ,  $I_{LOAD} = 10\text{ mA}$ ,  $C_{LOAD} = 1\text{ }\mu\text{F}$

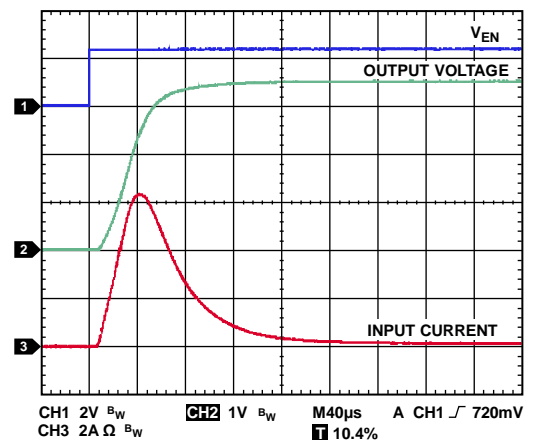

Figure 37. Typical Rise Time and Inrush Current,  $C_{LOAD} = 100\text{ }\mu\text{F}$ ,  $V_{IN} = 3.6\text{ V}$ ,  $I_{LOAD} = 100\text{ mA}$

The rise time is defined as the time it takes the output voltage to rise from 10% to 90% of  $V_{OUT}$  reaching its final value. It is dependent on the rise time of the internal charge pump.

For very large values of output capacitance, the RC time constant (where C is the load capacitance ( $C_{LOAD}$ ) and R is the  $R_{DS_{ON}} || R_{LOAD}$ ) can become a factor in the rise time of the output voltage. Because  $R_{DS_{ON}}$  is much smaller than  $R_{LOAD}$ , an adequate approximation for RC is  $R_{DS_{ON}} \times C_{LOAD}$ . An input or load capacitor is not required for the ADP199 although capacitors can be used to suppress noise on the board.

The turn-off time is defined as the time it takes for the output voltage to fall from 90% to 10% of  $V_{OUT}$  reaching its final value. The turn-off time is also dependent on the RC time constant of the output capacitance and load resistance. Figure 38 shows the typical turn-off time with  $V_{IN} = 1.8\text{ V}$ ,  $C_{OUT} = 1\text{ }\mu\text{F}$ , and  $R_{LOAD} = 18\text{ }\Omega$ .

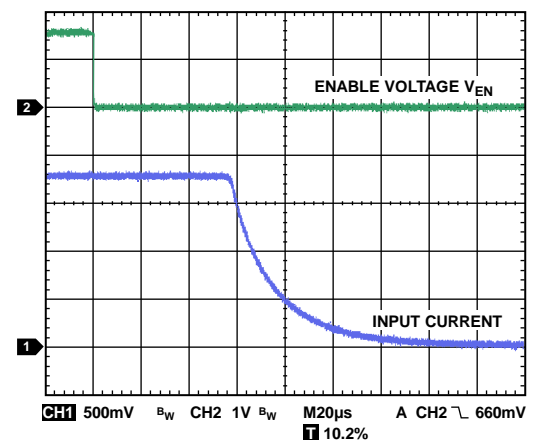

Figure 38. Typical Turn-Off Time

OUTLINE DIMENSIONS

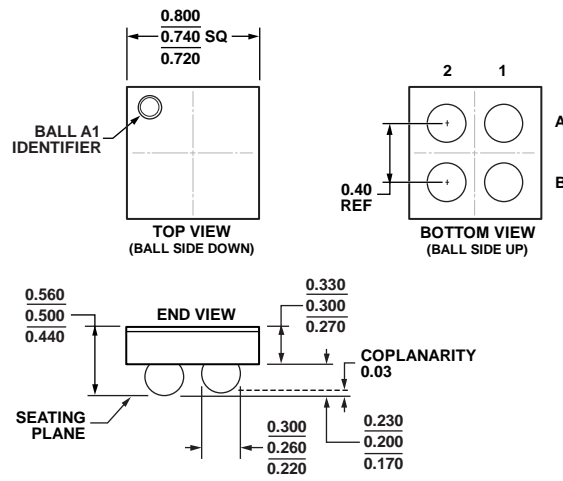

Figure 39. 4-Ball Wafer Level Chip Scale Package [WLCSP] (CB-4-5)

Dimensions shown in millimeters

07-17-2012-A

ORDERING GUIDE

Model <sup>1</sup>	Temperature Range	Package Description	Package Option	Branding
ADP199ACBZ-R7	-40°C to +85°C	4-Ball Wafer Level Chip Scale Package [WLCSP]	CB-4-5	8P
ADP199CB-EVALZ		Evaluation Board		

<sup>1</sup> Z = RoHS Compliant Part.

**NOTES**

**NOTES**