

Toshiba Intelligent Power Device Silicon Monolithic MOS Integrated Circuit

TPD1044F

Low-Side Switch for Motor, Solenoid and Lamp Drive

1. Description

The TPD1044F is a low-side switch. The IC has a vertical MOSFET output which can be directly driven from a CMOS or TTL logic circuit (e.g., an MPU). The IC is equipped with intelligent self-protection functions.

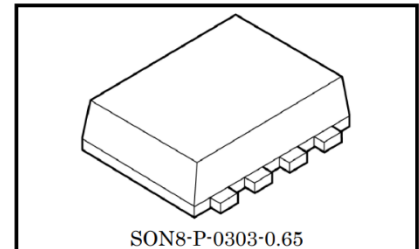

Weight: 0.017 g (typ.)

2. Applications

Motor drive, solenoid drive, lamp drive.

3. Features

- A monolithic IC with a new structure combining a control block and a vertical MOSFET on single chip.
- Can directly drive a power load from a CMOS or TTL logic IC.
- Built-in protection circuits against overvoltage (active clamp), overtemperature (thermal shutdown), and overcurrent (current limiter).
- Low Drain-Source ON-resistance: $R_{DS(ON)} = 0.6 \Omega$ (max) (@ $V_{IN} = 5 \text{ V}$, $I_D = 0.5 \text{ A}$, $T_{ch} = 25 \text{ }^\circ\text{C}$)
- Low Drain cut-off Current: $I_{DSS} = 10 \mu\text{A}$ (max) (@ $V_{IN} = 0 \text{ V}$, $V_{DS} = 30 \text{ V}$, $T_{ch} = 25 \text{ }^\circ\text{C}$)
- Low Input Current: $I_{IN} = 300 \mu\text{A}$ (max) (@ $V_{IN} = 5 \text{ V}$, $T_{ch} = 25 \text{ }^\circ\text{C}$)
- AEC-Q100 qualified.
- It is a surface-mounted package "PS-8" (named by Toshiba), and the packing is embossed-tape packing.

Note : Due to its MOS structure, this product is sensitive to static electricity.

Start of commercial production
2003-09

4. Block Diagram

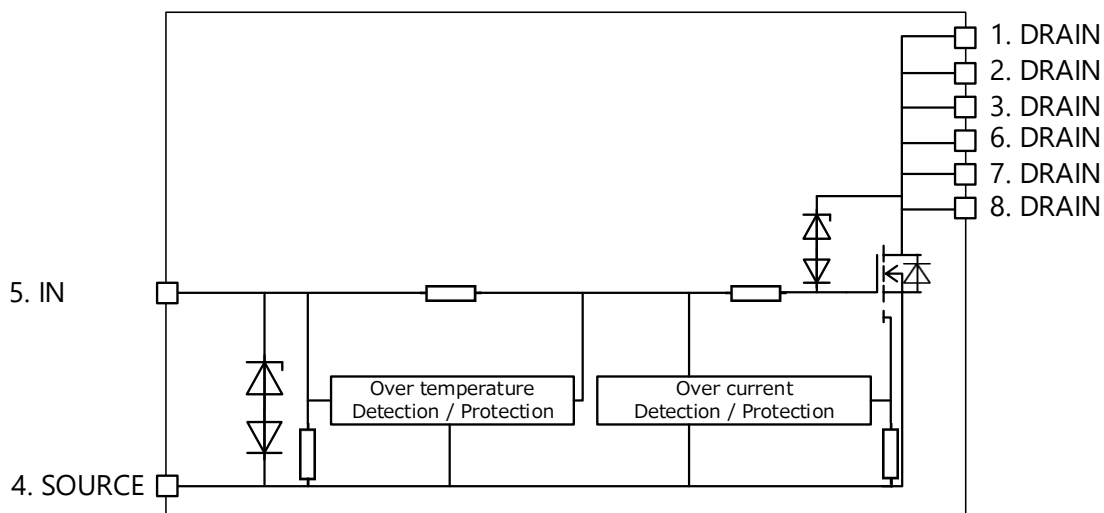

Figure 4.1 Block Diagram

5. Pin Assignments (Top view)

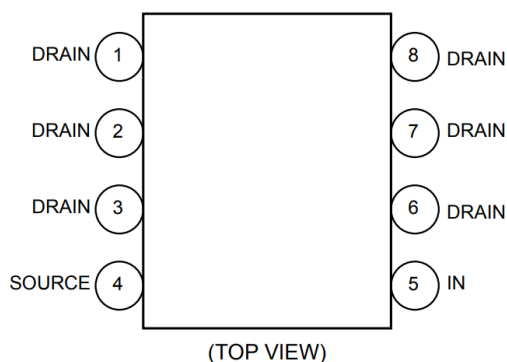

Figure 5.1 Pin Assignments (Top view)

6. Pin Description

Table 6.1 Pin Description

Pin No.	Symbol	Description
1,2,3,6,7,8	DRAIN	Drain current is limited (by current limiter) if it exceeds 1 A (min) in order to protect the IC.
4	SOURCE	Source pin.
5	IN	Input pin. This pin is connected to a pull-down resistor internally, so that even when input wiring is open-circuited, output can never be turned on inadvertently.

7. Timing chart

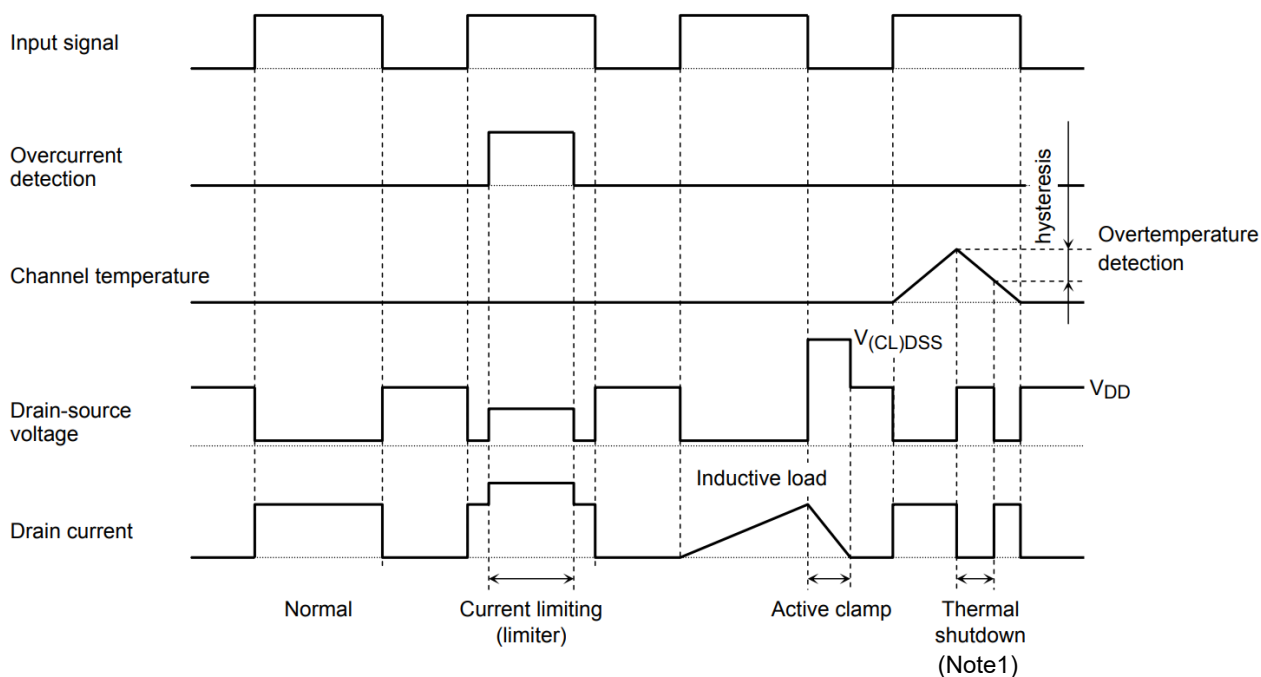

Figure 7.1 Timing chart

Note 1: The overtemperature detection is self-recovery. The detection and recovery hysteresis is 5 °C (typ.).

8. Truth table

Table 8.1 Truth table

IN	V_{DS}	Output state	Operation state
L	H	OFF	Normal
H	L	ON	
L	H	OFF	Overcurrent (load short)
H	H	current limiting (limiter)	
L	H	OFF	Overtemperature
H	H	OFF	

9. Absolute Maximum Ratings

Table 9.1 Absolute Maximum Ratings (Ta = 25 °C) (Note)

Characteristics	Symbol	Rating	Unit
Drain-source voltage	V _{DS} (DC)	41	V
Drain current	I _D	Internally limited	A
Input voltage	V _{IN}	-0.3 to 7.0	V
Power dissipation (Ta = 25 °C) (Note 1)	P _D	0.9	W
Single pulse active clamp capability (Note 2)	E _{AS}	125	mJ
Active clamp current	I _{AR}	1	A
Repetitive active clamp capability (Note 3)	E _{AR}	0.09	mJ
Operating temperature	T _{opr}	-40 to 125	°C
Channel temperature	T _{ch}	150	°C
Storage temperature	T _{stg}	-55 to 150	°C

Note: Using continuously under heavy loads (e.g. the application of high temperature/current/voltage and the significant change in temperature, etc.) may cause this product to decrease in the reliability significantly even if the operating conditions (i.e. operating temperature/current/voltage, etc.) are within the absolute maximum ratings and the operating ranges. Please design the appropriate reliability upon reviewing the Toshiba Semiconductor Reliability Handbook (“Handling Precautions”/Derating Concept and Methods) and individual reliability data (i.e. reliability test report and estimated failure rate, etc.).

Note 1: Refer to 10. Thermal Characteristics.

Note 2: Active clamp capability (single pulse) test condition V_{DS} = 40 V, T_{ch} = 25°C(initial), L = 50 mH, I_{AR} = 1 A, R_G = 25 Ω

Note 3: Repetitive rating, pulse width limited by maximum channel temperature.

10. Thermal Characteristics

Table 10.1 Thermal characteristics

Characteristics	Symbol	Max	Unit
Thermal resistance, channel to ambient (Note 4)	R _{th (ch-a)}	138.9	°C/W

$$P_D = (T_{ch} - T_a) / R_{th (ch-a)}$$

Note 4: Thermal resistance measurement conditions.

Mounted on glass epoxy board (FR-4) [25.4 mm × 25.4 mm × 0.8 mm]



11. Electrical Characteristics

Table 11.1 Electrical Characteristics (Ta = 25 °C)

Characteristics	Symbol	Test circuit	Test Condition	Min	Typ.	Max	Unit
Drain-source clamp voltage	$V_{(CL) DSS}$	-	$V_{IN} = 0\text{ V}, I_D = 1\text{ mA}$	41	-	60	V
Input threshold voltage	V_{th}	-	$V_{DS} = 13\text{ V}, I_D = 10\text{ mA}$	1.0	-	2.8	V
Protective circuit operation input voltage range	$V_{IN (opr)}$	-	-	3	-	6	V
Drain cut-off current	I_{DSS}	-	$V_{IN} = 0\text{ V}, V_{DS} = 30\text{ V}$	-	-	10	μA
Input current	$I_{IH (1)}$	-	$V_{IN} = 5\text{ V}$, at normal operation	-	-	300	μA
	$I_{IH (2)}$	-	$V_{IN} = 5\text{ V}$, when overcurrent protective circuit is actuated	-	-	350	
Drain-source on resistance	$R_{DS (ON)}$	-	$V_{IN} = 5\text{ V}, I_D = 0.5\text{ A}$	-	0.44	0.60	Ω
Overtemperature detection	T_{OT}	-	$V_{IN} = 5\text{ V}$	150	160	-	$^{\circ}\text{C}$
Overcurrent detection	I_{OC}	1	$V_{IN} = 5\text{ V}$	1.0	1.8	-	A
Switching time	t_{on}	2	$V_{DD} = 13\text{ V}, V_{IN} = 0\text{ V} / 5\text{ V}, I_D = 0.5\text{ A}$	-	10	-	μs
	t_{off}			-	15	-	

Test circuit 1: Overcurrent measuring circuit

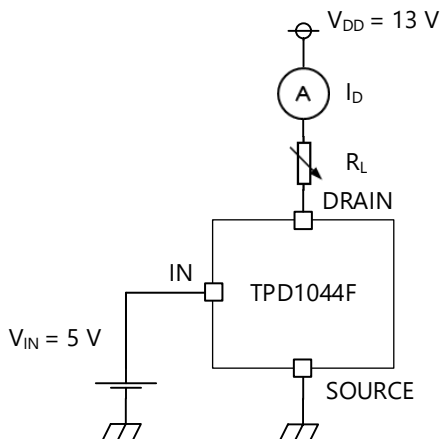

Figure 11.1 Test circuit 1

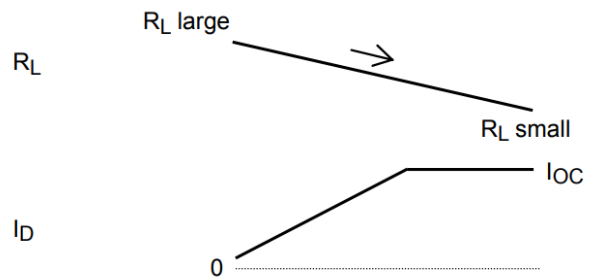

Figure 11.2 Measured waveforms 1

Test circuit 2: Switching time measuring circuit

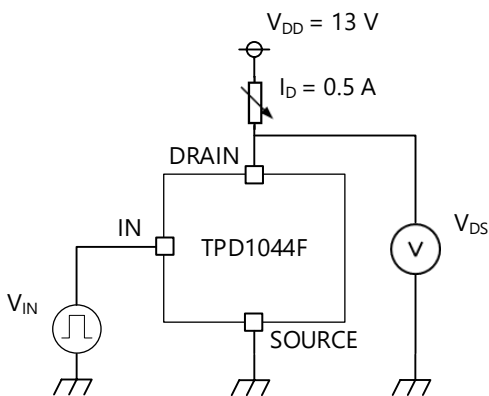

Figure 11.3 Test circuit 2

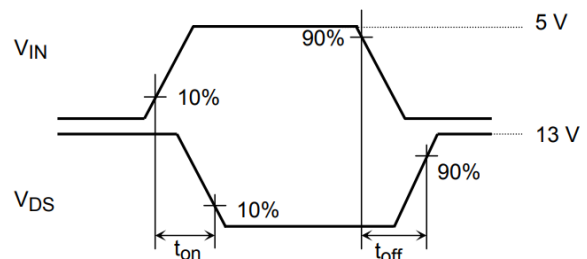

Figure 11.4 Measured waveforms 2

12. Characteristic curves

Note: The above characteristics curves are presented for reference only and not guaranteed by production test, unless otherwise noted.

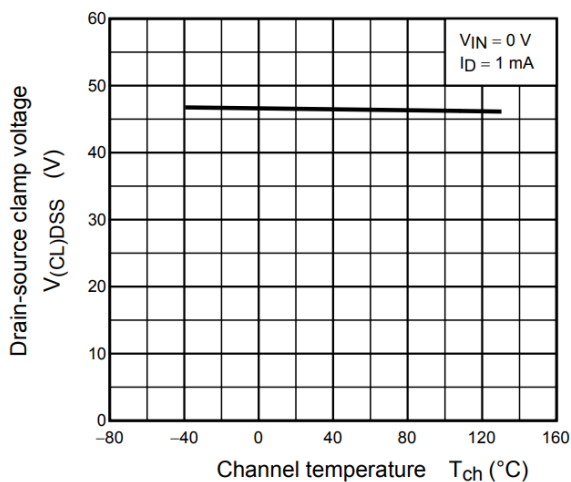

Figure 12.1 $V_{(CL)DSS} - T_{ch}$

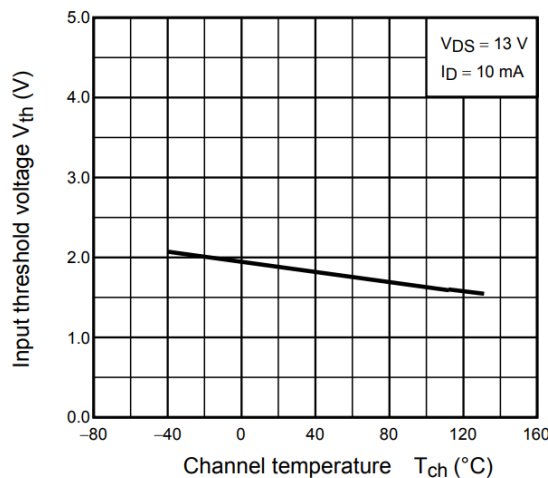

Figure 12.2 $V_{th} - T_{ch}$

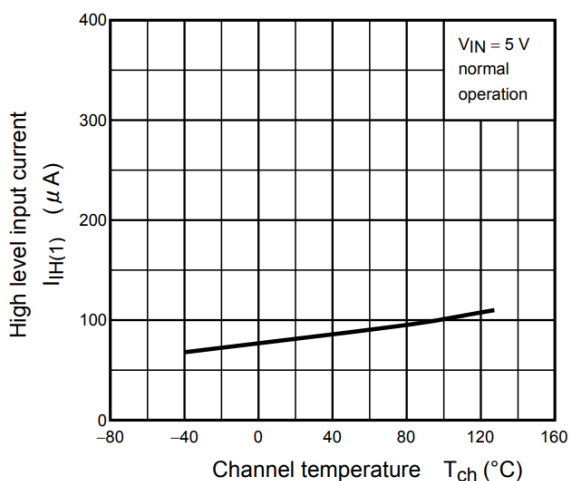

Figure 12.3 $I_{IH(1)} - T_{ch}$

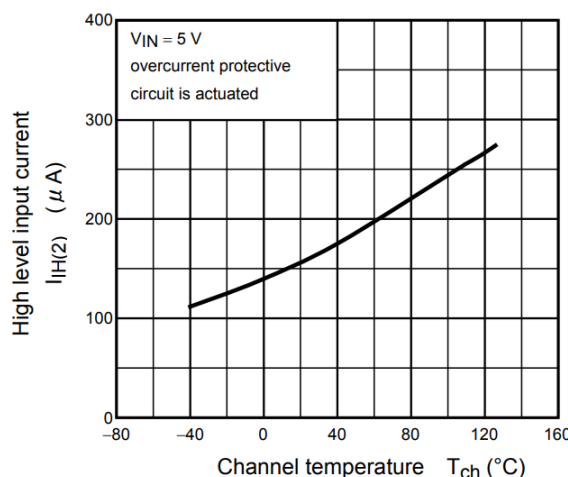

Figure 12.4 $I_{IH(2)} - T_{ch}$

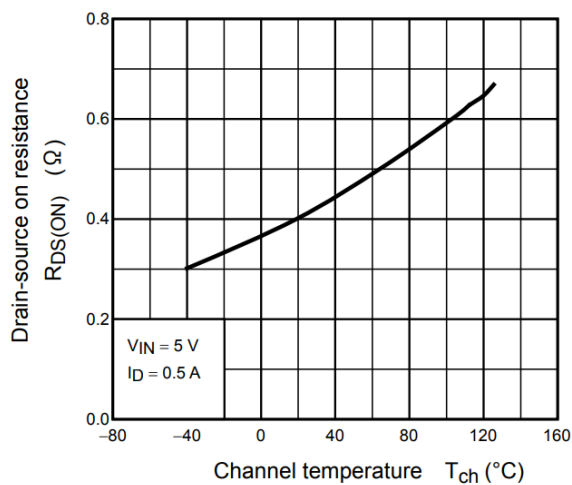

Figure 12.5 $R_{DS(ON)} - T_{ch}$

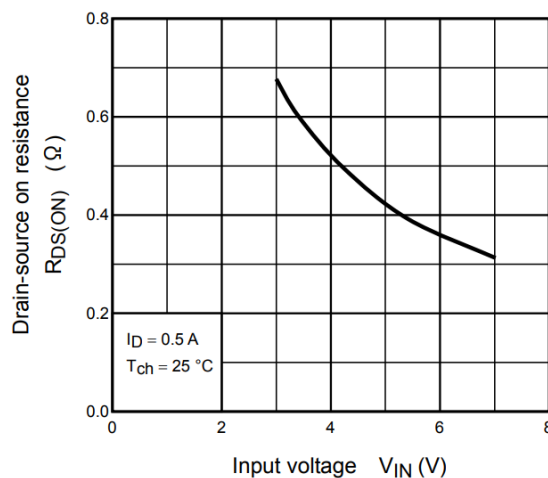

Figure 12.6 $R_{DS(ON)} - V_{IN}$

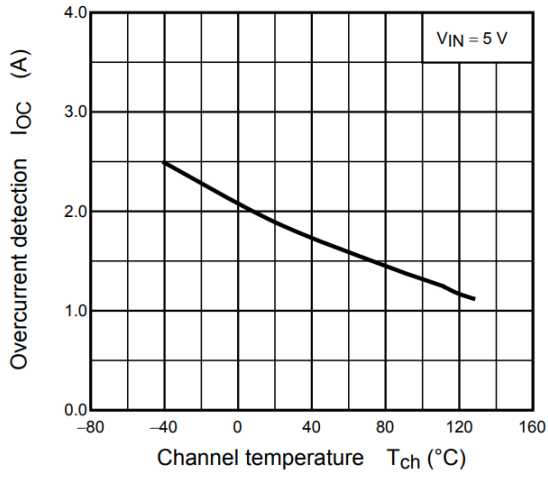

Figure 12.7 $I_{OC} - T_{ch}$

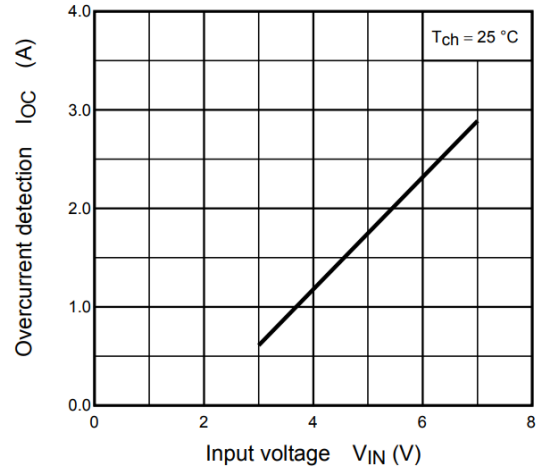

Figure 12.8 $I_{OC} - V_{IN}$

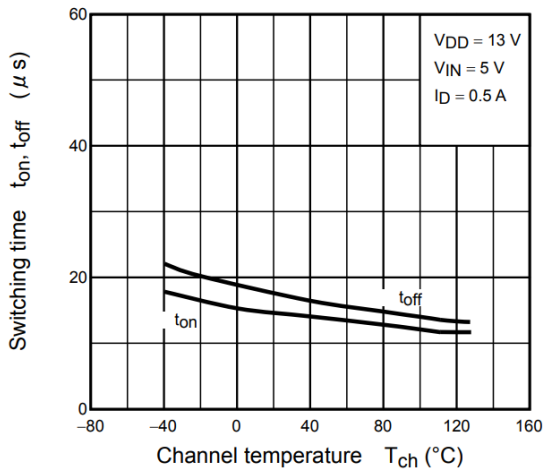

Figure 12.9 $t_{on}, t_{off} - T_{ch}$

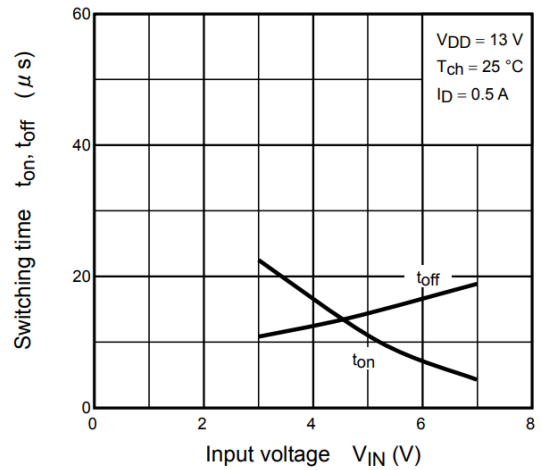

Figure 12.10 $t_{on}, t_{off} - V_{IN}$

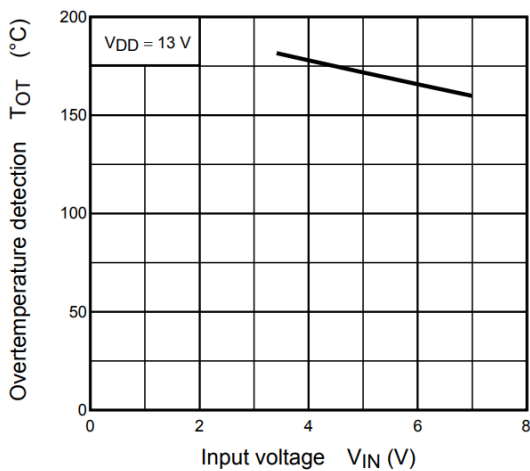

Figure 12.11 $T_{OT} - V_{IN}$

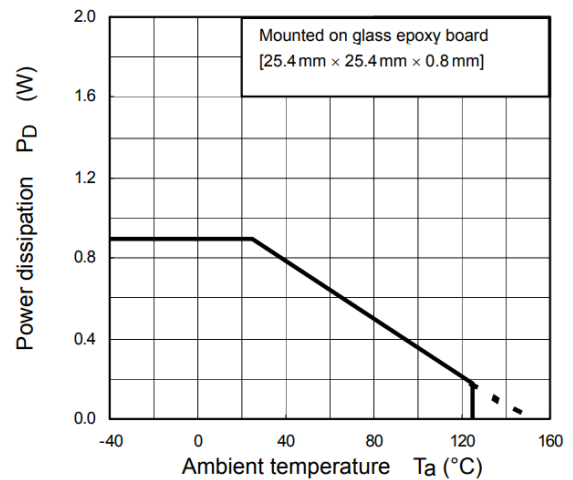

Figure 12.12 $P_D - T_a$

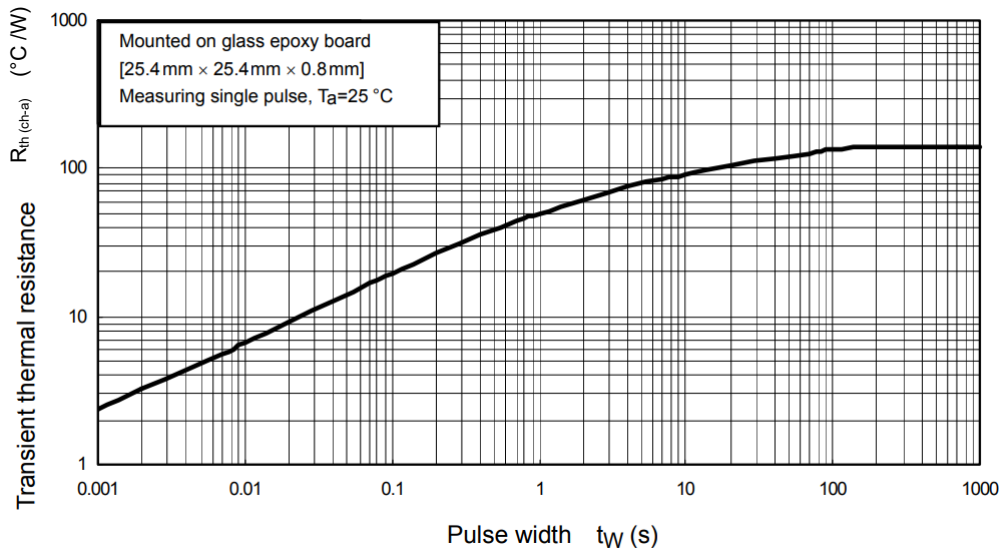
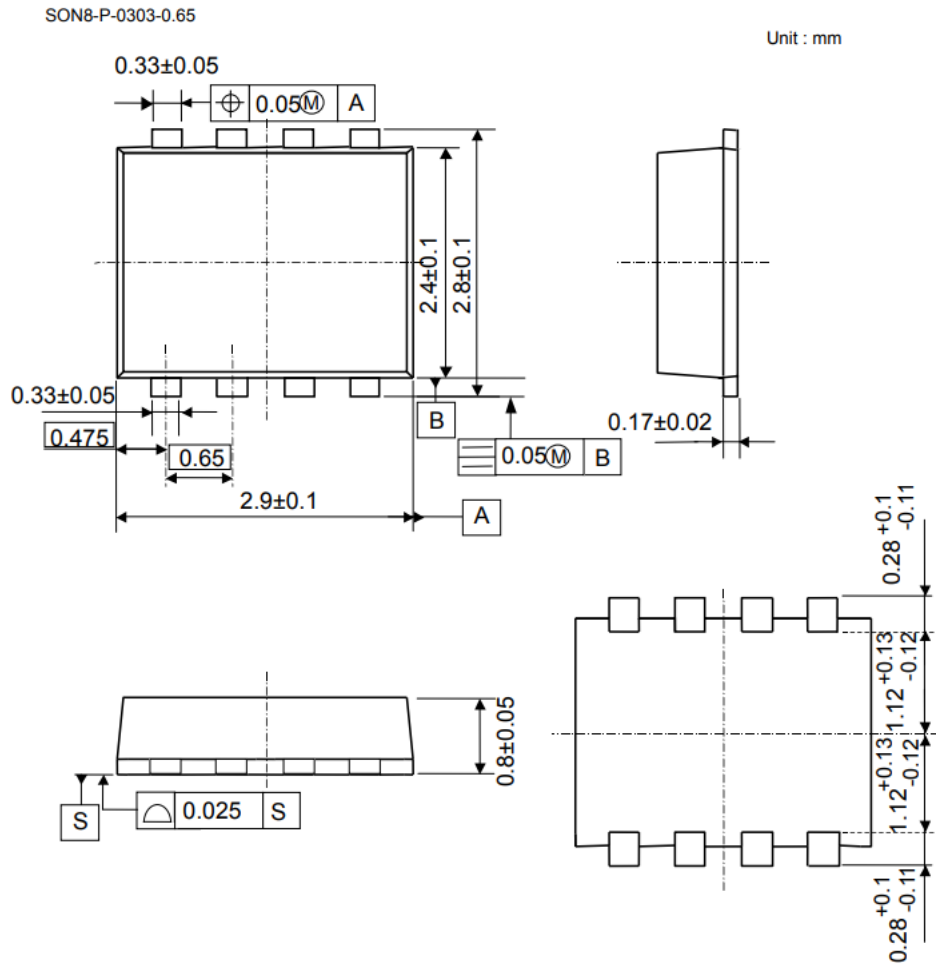

Figure 12.13 $R_{th(ch-a)} - t_w$

13. Package Information

13.1. Package Dimensions



Weight: 0.017 g (Typ.)

Figure 13.1 Package Dimensions

13.2. Marking

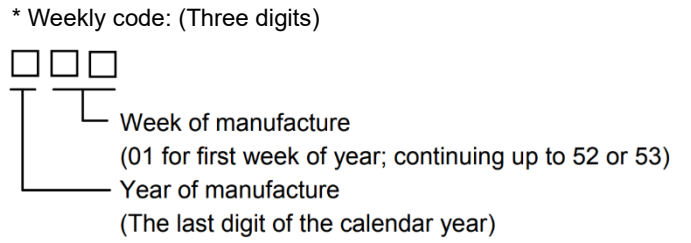
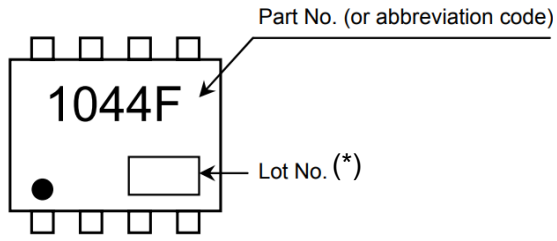

Figure 13.2 Marking

Note: The (●) on the lower left of the marking indicates Pin 1.

13.3. Land Pattern Dimensions for Reference only

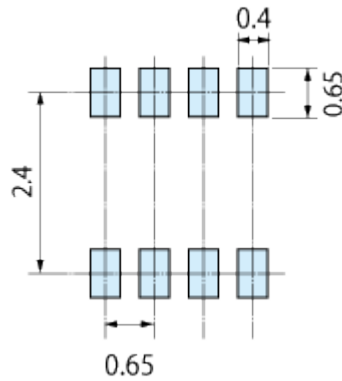

Figure 13.3 Land Pattern Dimensions for Reference only

14. IC Usage Considerations

14.1. Notes on Handling of ICs

The absolute maximum ratings of a semiconductor device are a set of ratings that must not be exceeded, even for a moment. None of the multiple ratings can be exceeded. Exceeding the absolute maximum ratings may cause destruction, damage and deterioration, and may result in injury due to explosion or burning.

RESTRICTIONS ON PRODUCT USE

Toshiba Corporation and its subsidiaries and affiliates are collectively referred to as "TOSHIBA". Hardware, software and systems described in this document are collectively referred to as "Product".

- TOSHIBA reserves the right to make changes to the information in this document and related Product without notice.
- This document and any information herein may not be reproduced without prior written permission from TOSHIBA. Even with TOSHIBA's written permission, reproduction is permissible only if reproduction is without alteration/omission.
- Though TOSHIBA works continually to improve Product's quality and reliability, Product can malfunction or fail. Customers are responsible for complying with safety standards and for providing adequate designs and safeguards for their hardware, software and systems which minimize risk and avoid situations in which a malfunction or failure of Product could cause loss of human life, bodily injury or damage to property, including data loss or corruption. Before customers use the Product, create designs including the Product, or incorporate the Product into their own applications, customers must also refer to and comply with (a) the latest versions of all relevant TOSHIBA information, including without limitation, this document, the specifications, the data sheets and application notes for Product and the precautions and conditions set forth in the "TOSHIBA Semiconductor Reliability Handbook" and (b) the instructions for the application with which the Product will be used with or for. Customers are solely responsible for all aspects of their own product design or applications, including but not limited to (a) determining the appropriateness of the use of this Product in such design or applications; (b) evaluating and determining the applicability of any information contained in this document, or in charts, diagrams, programs, algorithms, sample application circuits, or any other referenced documents; and (c) validating all operating parameters for such designs and applications. **TOSHIBA ASSUMES NO LIABILITY FOR CUSTOMERS' PRODUCT DESIGN OR APPLICATIONS.**
- **PRODUCT IS NEITHER INTENDED NOR WARRANTED FOR USE IN EQUIPMENTS OR SYSTEMS THAT REQUIRE EXTRAORDINARILY HIGH LEVELS OF QUALITY AND/OR RELIABILITY, AND/OR A MALFUNCTION OR FAILURE OF WHICH MAY CAUSE LOSS OF HUMAN LIFE, BODILY INJURY, SERIOUS PROPERTY DAMAGE AND/OR SERIOUS PUBLIC IMPACT ("UNINTENDED USE").** Except for specific applications as expressly stated in this document, Unintended Use includes, without limitation, equipment used in nuclear facilities, equipment used in the aerospace industry, lifesaving and/or life supporting medical equipment, equipment used for automobiles, trains, ships and other transportation, traffic signaling equipment, equipment used to control combustions or explosions, safety devices, elevators and escalators, and devices related to power plant. **IF YOU USE PRODUCT FOR UNINTENDED USE, TOSHIBA ASSUMES NO LIABILITY FOR PRODUCT.** For details, please contact your TOSHIBA sales representative or contact us via our website.
- Do not disassemble, analyze, reverse-engineer, alter, modify, translate or copy Product, whether in whole or in part.
- Product shall not be used for or incorporated into any products or systems whose manufacture, use, or sale is prohibited under any applicable laws or regulations.
- The information contained herein is presented only as guidance for Product use. No responsibility is assumed by TOSHIBA for any infringement of patents or any other intellectual property rights of third parties that may result from the use of Product. No license to any intellectual property right is granted by this document, whether express or implied, by estoppel or otherwise.
- **ABSENT A WRITTEN SIGNED AGREEMENT, EXCEPT AS PROVIDED IN THE RELEVANT TERMS AND CONDITIONS OF SALE FOR PRODUCT, AND TO THE MAXIMUM EXTENT ALLOWABLE BY LAW, TOSHIBA (1) ASSUMES NO LIABILITY WHATSOEVER, INCLUDING WITHOUT LIMITATION, INDIRECT, CONSEQUENTIAL, SPECIAL, OR INCIDENTAL DAMAGES OR LOSS, INCLUDING WITHOUT LIMITATION, LOSS OF PROFITS, LOSS OF OPPORTUNITIES, BUSINESS INTERRUPTION AND LOSS OF DATA, AND (2) DISCLAIMS ANY AND ALL EXPRESS OR IMPLIED WARRANTIES AND CONDITIONS RELATED TO SALE, USE OF PRODUCT, OR INFORMATION, INCLUDING WARRANTIES OR CONDITIONS OF MERCHANTABILITY, FITNESS FOR A PARTICULAR PURPOSE, ACCURACY OF INFORMATION, OR NONINFRINGEMENT.**
- Do not use or otherwise make available Product or related software or technology for any military purposes, including without limitation, for the design, development, use, stockpiling or manufacturing of nuclear, chemical, or biological weapons or missile technology products (mass destruction weapons). Product and related software and technology may be controlled under the applicable export laws and regulations including, without limitation, the Japanese Foreign Exchange and Foreign Trade Law and the U.S. Export Administration Regulations. Export and re-export of Product or related software or technology are strictly prohibited except in compliance with all applicable export laws and regulations.
- Please contact your TOSHIBA sales representative for details as to environmental matters such as the RoHS compatibility of Product. Please use Product in compliance with all applicable laws and regulations that regulate the inclusion or use of controlled substances, including without limitation, the EU RoHS Directive. **TOSHIBA ASSUMES NO LIABILITY FOR DAMAGES OR LOSSES OCCURRING AS A RESULT OF NONCOMPLIANCE WITH APPLICABLE LAWS AND REGULATIONS.**

TOSHIBA ELECTRONIC DEVICES & STORAGE CORPORATION

<https://toshiba.semicon-storage.com/>