

National Semiconductor is now part of  
Texas Instruments.

Search <http://www.ti.com/> for the latest technical  
information and details on our current products and services.

## DS36276 FAILSAFE Multipoint Transceiver

### General Description

The DS36276 FAILSAFE Multipoint Transceiver is designed for use on bi-directional differential busses. It is compatible with existing TIA/EIA-485 transceivers, however, it offers an additional feature not supported by standard transceivers.

The FAILSAFE feature guarantees the receiver output to a known state when the Interface is in the following conditions: Floating Line, Idle Line (no active drivers), and Line Fault conditions (open or short). The receiver output is in a HIGH state for the following conditions: OPEN Inputs, Terminated Inputs ( $50\Omega$ ), and SHORTED Inputs.

FAILSAFE is a highly desirable feature when the transceivers are used with Asynchronous Controllers such as UARTs.

### Features

- FAILSAFE receiver, RO = HIGH for:
  - OPEN inputs
  - Terminated inputs
  - SHORTED inputs
- Compatible with popular interface standards:
  - TIA/EIA-485 (RS-485)
  - TIA/EIA-422-A (RS-422-A)
  - CCITT Recommendation V.11
- Bi-Directional Transceiver
  - Designed for multipoint transmission
- Separate driver input, driver enable, receiver enable, and receiver output for maximum flexibility
- Wide bus common mode range
  - ( $-7V$  to  $+12V$ )
- Pin compatible with: DS75176B, DS96176, DS3695 and SN75176A and B
- Available in SOIC package

### Connection and Logic Diagram

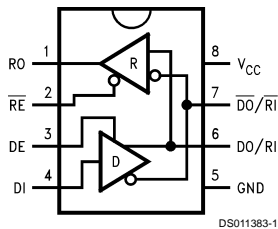

Order Number DS36276M  
See NS Package Number M08A

### Truth Tables

#### Driver

Inputs			Outputs	
$\overline{RE}$	DE	DI	DO/RI	$\overline{DO/RI}$
X	H	H	H	L
X	H	L	L	H
X	L	X	Z	Z

#### Receiver

Inputs			Output
$\overline{RE}$	DE	$RI-\overline{RI}$	RO
L	L	$\geq 0V$	H
L	L	$\leq -500\text{ mV}$	L
H	X	X	Z

#### Receiver FAILSAFE

Inputs			Output
$\overline{RE}$	DE	$RI-\overline{RI}$	RO
L	L	SHORTED	H
L	L	OPEN	H
H	X	X	Z

## Absolute Maximum Ratings (Note 1)

If Military/Aerospace specified devices are required, please contact the National Semiconductor Sales Office/Distributors for availability and specifications.

Supply Voltage ( $V_{CC}$ )	7V
Input Voltage (DE, $\overline{RE}$ , and DI)	5.5V
Driver Output Voltage/Receiver Input Voltage	-10V to +15V
Receiver Output Voltage (RO)	5.5V
Maximum Package Power Dissipation @ +25°C	
M Package (derate 5.8 mW/°C above +25°C)	726 mW
Storage Temperature Range	-65°C to +150°C

Lead Temperature (Soldering 4 sec.)	260°C
Max Junction Temperature	150°C
ESD Rating (HBM, 1.5 kΩ, 100 pF)	≥ 6.0 kV

## Recommended Operating Conditions

	Min	Max	Units
Supply Voltage, $V_{CC}$	4.75	5.25	V
Bus Voltage	-7	+12	V
Operating Temperature ( $T_A$ ) DS36276	0	+70	°C

## Electrical Characteristics (Notes 2, 4)

Over recommended Supply Voltage and Operating Temperature ranges, unless otherwise specified.

Symbol	Parameter	Conditions	Min	Typ	Max	Units		
<b>DRIVER CHARACTERISTICS</b>								
$V_{OD}$	Differential Output Voltage	$I_O = 0$ mA (No Load)	1.5	4.8	6.0	V		
$V_{ODO}$	Output Voltage	$I_O = 0$ mA (Output to GND)	0		6.0	V		
$V_{\overline{ODO}}$	Output Voltage		0		6.0	V		
$V_{T1}$	Differential Output Voltage (Termination Load)	$R_L = 54\Omega$ (485)	(Figure 1)		1.5	2.0	5.0	V
		$R_L = 100\Omega$ (422)	2.0	2.3	5.0	V		
$\Delta V_{T1}$	Balance of $V_{T1}$ $ V_{T1}  -  \overline{V_{T1}} $	$R_L = 54\Omega$	(Note 3)		-0.2	0.07	+0.2	V
		$R_L = 100\Omega$	-0.2	0.07	+0.2	V		
$V_{OS}$	Driver Common Mode Output Voltage	$R_L = 54\Omega$	(Figure 1)		0	2.5	3.0	V
		$R_L = 100\Omega$	0	2.3	3.0	V		
$\Delta V_{OS}$	Balance of $V_{OS}$ $ V_{OS}  -  \overline{V_{OS}} $	$R_L = 54\Omega$	(Note 3)		-0.2	0.08	+0.2	V
		$R_L = 100\Omega$	-0.2	0.08	+0.2	V		
$I_{OSD}$	Driver Short-Circuit Output Current	$V_O = +12V$	(Figure 3)			134	290	mA
		$V_O = V_{CC}$		140		mA		
		$V_O = 0V$		-140		mA		
		$V_O = -7V$		-180	-290	mA		
<b>RECEIVER CHARACTERISTICS</b>								
$V_{TH}$	Differential Input High Threshold Voltage (Note 5)	$V_O = V_{OH}$ , $I_O = -0.4$ mA $-7V \leq V_{CM} \leq +12V$		-0.18	0	V		
$V_{TL}$	Differential Input Low Threshold Voltage (Note 5)	$V_O = V_{OL}$ , $I_O = 8.0$ mA $-7V \leq V_{CM} \leq +12V$	-0.5	-0.23		V		
$V_{HST}$	Hysteresis (Note 6)	$V_{CM} = 0V$		50		mV		
$I_{IN}$	Line Input Current ( $V_{CC} = 4.75V, 5.25V, 0V$ )	Other Input = 0V DE = $V_{IH}$ (Note 7)	$V_I = +12V$		0.7	1.0	mA	
			$V_I = -7V$		-0.5	-0.8	mA	
$I_{OSR}$	Short Circuit Current	$V_O = 0V$	RO	-5.0	-30	-85	mA	
$I_{OZ}$	TRI-STATE® Leakage Current	$V_O = 0.4$ to 2.4V		-20		+20	μA	
$V_{OH}$	Output High Voltage (Figure 12)	$V_{ID} = 0V$ , $I_{OH} = -0.4$ mA		2.5	3.5		V	
		$V_{ID} = OPEN$ , $I_{OH} = -0.4$ mA		2.5	3.5		V	
$V_{OL}$	Output Low Voltage (Figure 12)	$V_{ID} = -0.5V$ , $I_{OL} = +8$ mA		0.25	0.6	V		
		$V_{ID} = -0.5V$ , $I_{OL} = +16$ mA		0.35	0.7	V		
$R_{IN}$	Input Resistance		12	19		kΩ		

## Electrical Characteristics (Notes 2, 4) (Continued)

Over recommended Supply Voltage and Operating Temperature ranges, unless otherwise specified.

Symbol	Parameter	Conditions	Min	Typ	Max	Units
<b>DEVICE CHARACTERISTICS</b>						
$V_{IH}$	High Level Input Voltage		2.0		$V_{CC}$	V
$V_{IL}$	Low Level Input Voltage		GND		0.8	V
$I_{IH}$	High Level Input Current	$V_{IH} = 2.4V$			20	$\mu A$
$I_{IL}$	Low Level Input Current	$V_{IL} = 0.4V$			-100	$\mu A$
$V_{CL}$	Input Clamp Voltage	$I_{CL} = -18 mA$		-0.75	-1.5	V
$I_{CC}$	Output Low Voltage	DE = 3V, $\overline{RE} = 0V$ , DI = 0V		42	60	mA
$I_{CCR}$	Supply Current	DE = 0V, $\overline{RE} = 0V$ , DI = 0V		28	45	mA
$I_{CCD}$	(No Load)	DE = 3V, $\overline{RE} = 3V$ , DI = 0V		43	60	mA
$I_{CCX}$		DE = 0V, $\overline{RE} = 3V$ , DI = 0V		31	50	mA

## Switching Characteristics (Note 4)

Over recommended Supply Voltage and Operating Temperature ranges, unless otherwise specified.

Symbol	Parameter	Conditions	Min	Typ	Max	Units
<b>DRIVER CHARACTERISTICS</b>						
$t_{PLHD}$	Diff. Prop. Delay Low to High	$R_L = 54\Omega$ $C_L = 50 pF$ $C_D = 50 pF$ (Figures 4, 5)	7	21	60	ns
$t_{PHLD}$	Diff. Prop. Delay High to Low		7	19	60	ns
$t_{SKD}$	Diff. Skew ( $ t_{PLHD} - t_{PHLD} $ )		2	10	ns	
$t_r$	Diff. Rise Time		12	50	ns	
$t_f$	Diff. Fall Time		12	50	ns	
$t_{PLH}$	Prop. Delay Low to High	$R_L = 27\Omega$ , $C_L = 15 pF$ (Figures 6, 7)		22	45	ns
$t_{PHL}$	Prop. Delay High to Low			22	45	ns
$t_{PZH}$	Enable Time Z to High	$R_L = 110\Omega$ $C_L = 50 pF$ (Figure 8 - Figure 11)		32	55	ns
$t_{PZL}$	Enable Time Z to Low			32	65	ns
$t_{PHZ}$	Disable Time High to Z			22	55	ns
$t_{PLZ}$	Disable Time Low to Z			16	55	ns
<b>RECEIVER CHARACTERISTICS</b>						
$t_{PLH}$	Prop. Delay Low to High	$V_{ID} = -1.5V$ to $+1.5V$ $C_L = 15 pF$ (Figures 13, 14)	15	40	70	ns
$t_{PHL}$	Prop. Delay High to Low		15	42	70	ns
$t_{SK}$	Skew ( $ t_{PLH} - t_{PHL} $ )		2	15	ns	
$t_{PZH}$	Enable Time Z to High	$C_L = 15 pF$ (Figures 15, 16)		15	50	ns
$t_{PZL}$	Enable Time Z to Low			17	50	ns
$t_{PHZ}$	Disable Time High to Z			24	50	ns
$t_{PLZ}$	Disable Time Low to Z			19	50	ns

**Note 1:** "Absolute Maximum Ratings" are those values beyond which the safety of the device cannot be guaranteed. They are not meant to imply that the devices should be operated at these limits. The tables of "Electrical Characteristics" specify conditions for device operation.

**Note 2:** Current into device pins is defined as positive. Current out of device pins is defined as negative. All voltages are referenced to ground unless otherwise specified.

**Note 3:**  $\Delta |V_{T1}|$  and  $\Delta |V_{OS}|$  are changes in magnitude of  $V_{T1}$  and  $V_{OS}$ , respectively, that occur when the input changes state.

**Note 4:** All typicals are given for  $V_{CC} = 5.0V$  and  $T_A = +25^\circ C$ .

**Note 5:** Threshold parameter limits specified as an algebraic value rather than by magnitude.

**Note 6:** Hysteresis defined as  $V_{HST} = V_{TH} - V_{TL}$ .

**Note 7:**  $I_{IN}$  includes the receiver input current and driver TRI-STATE leakage current.

## Parameter Measurement Information

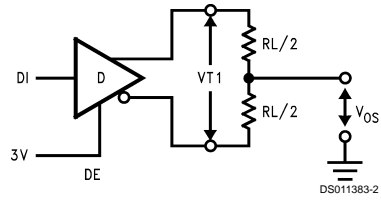

FIGURE 1. Driver  $V_{T1}$  and  $V_{OS}$  Test Circuit

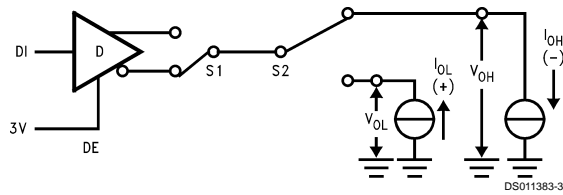

FIGURE 2. Driver  $V_{OH}$  and  $V_{OL}$  Test Circuit

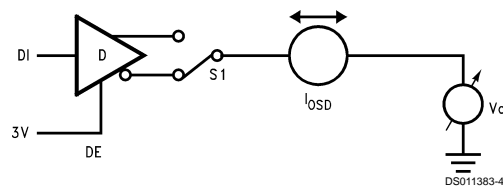

FIGURE 3. Driver Short Circuit Test Circuit

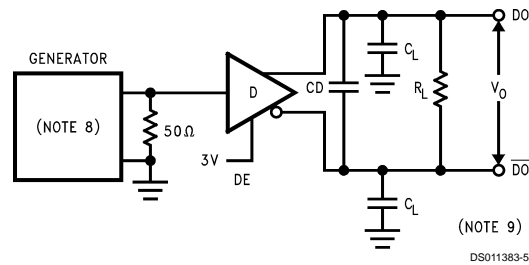
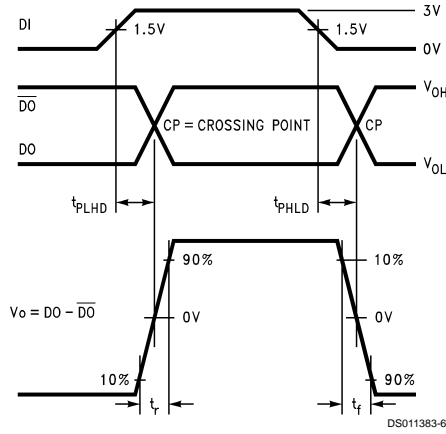
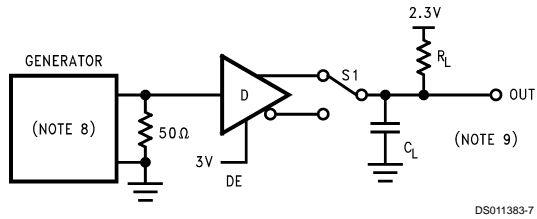

FIGURE 4. Driver Differential Propagation Delay and Transition Time Test Circuit

**Parameter Measurement Information** (Continued)



**FIGURE 5. Driver Differential Propagation Delays and Transition Times**



**FIGURE 6. Driver Propagation Delay Test Circuit**

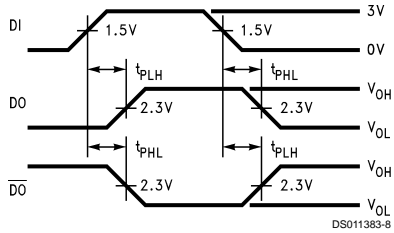

**FIGURE 7. Driver Propagation Delays**

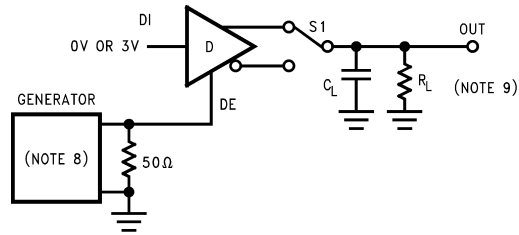

**FIGURE 8. Driver TRI-STATE Test Circuit ( $t_{PZH}$ ,  $t_{PHZ}$ )**

S1 to DO for DI = 3V  
S1 to  $\overline{DO}$  for DI = 0V

## Parameter Measurement Information (Continued)

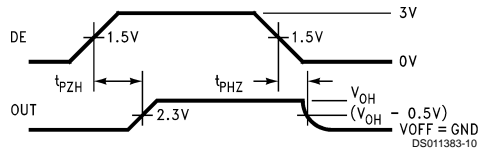
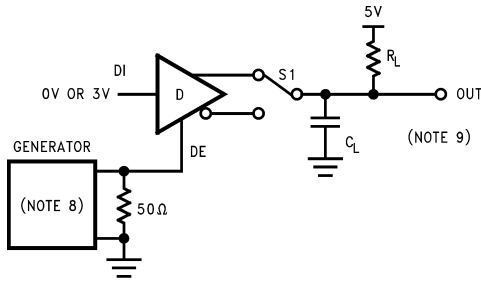

FIGURE 9. Driver TRI-STATE Delays ( $t_{PZH}$ ,  $t_{PHZ}$ )



S1 to  $\overline{DO}$  for DI = 0V  
S1 to  $\overline{DO}$  for DI = 3V

FIGURE 10. Driver TRI-STATE Test Circuit ( $t_{PZL}$ ,  $t_{PLZ}$ )

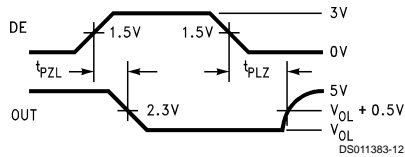

FIGURE 11. Driver TRI-STATE Delays ( $t_{PZL}$ ,  $t_{PLZ}$ )

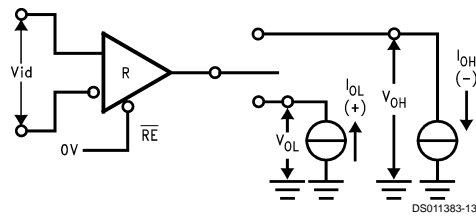

FIGURE 12. Receiver  $V_{OH}$  and  $V_{OL}$

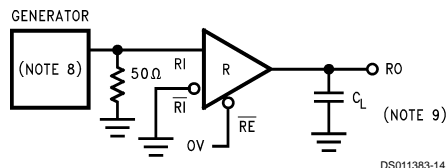

FIGURE 13. Receiver Propagation Delay Test Circuit

## Parameter Measurement Information (Continued)

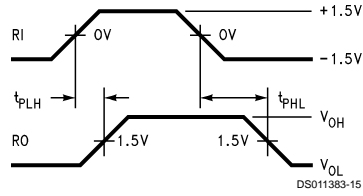

FIGURE 14. Receiver Propagation Delays

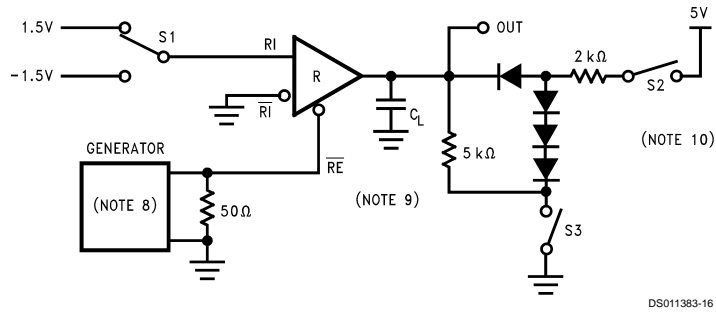
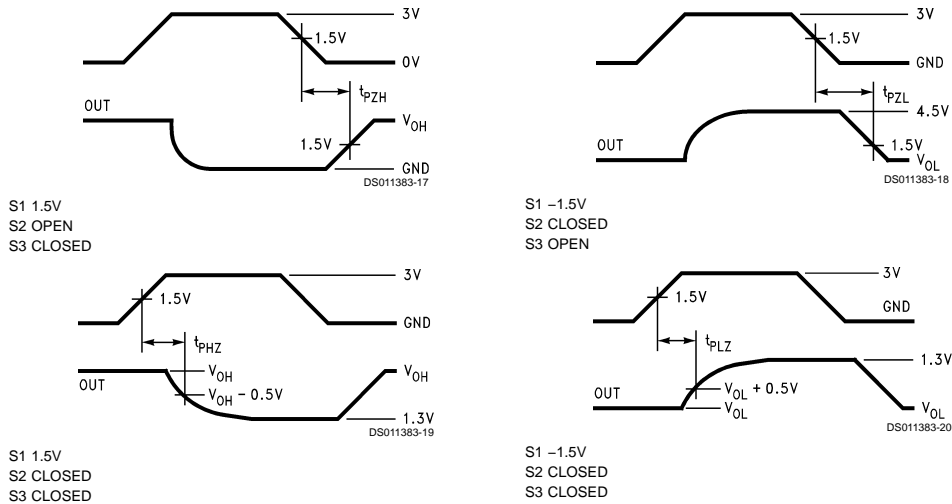

FIGURE 15. Receiver TRI-STATE Delay Test Circuit



**Note 8:** The input pulse is supplied by a generator having the following characteristics:  $f = 1.0$  MHz, 50% duty cycle,  $t_r$  and  $t_f < 6.0$  ns,  $Z_0 = 50\Omega$ .

**Note 9:**  $C_L$  includes probe and stray capacitance.

**Note 10:** Diodes are 1N916 or equivalent.

FIGURE 16. Receiver Enable and Disable Timing



## Typical Performance Characteristics

**Differential Output Voltage vs Output Current**

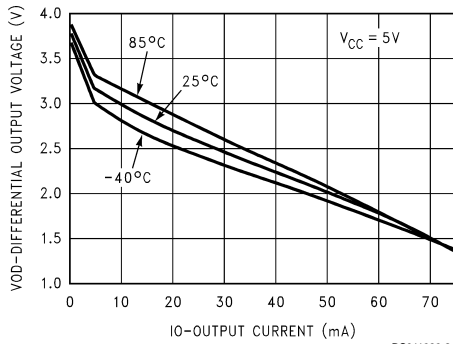

DS011383-21

**Differential Output Voltage vs Output Current**

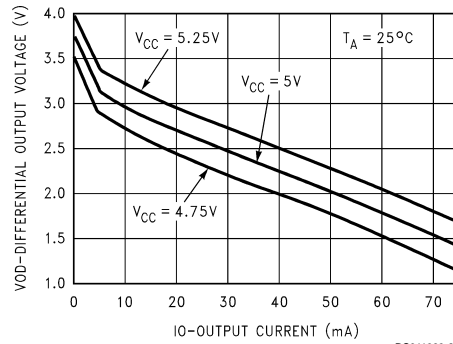

DS011383-22

**Driver VOH vs IOH vs VCC**

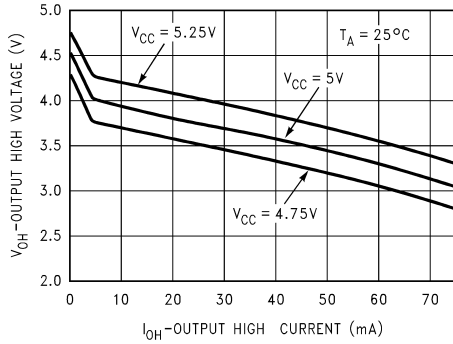

DS011383-23

**Driver VOH vs IOH vs Temperature**

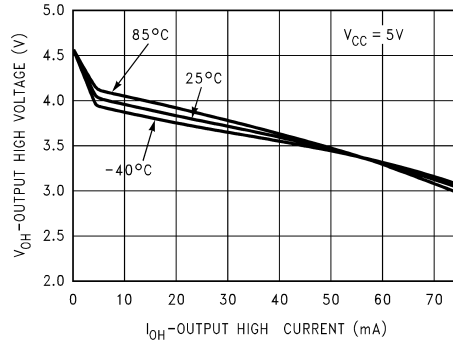

DS011383-24

**Driver VOL vs IOL vs VCC**

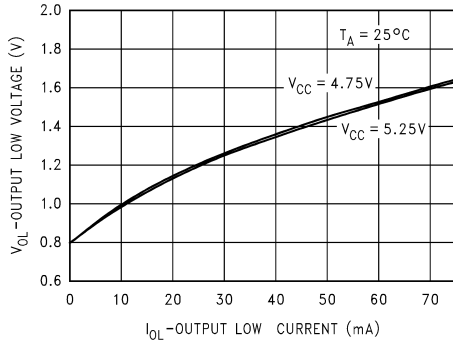

DS011383-25

**Driver VOL vs IOL vs Temperature**

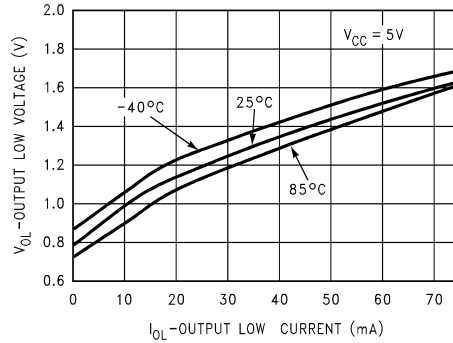

DS011383-26

## Typical Performance Characteristics (Continued)

Receiver  $V_{OH}$  vs  $I_{OH}$  vs  $V_{CC}$

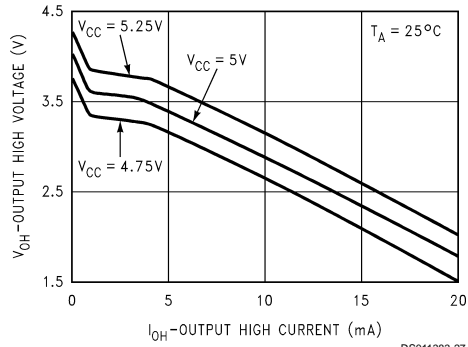

Receiver  $V_{OH}$  vs  $I_{OH}$  vs Temperature

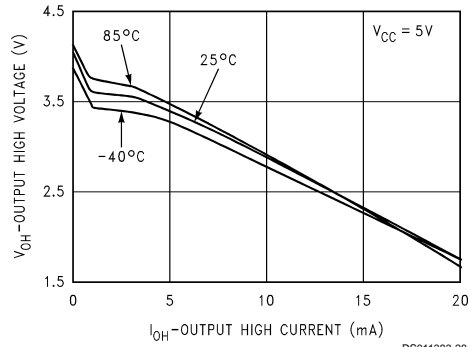

Receiver  $V_{OL}$  vs  $I_{OL}$  vs  $V_{CC}$

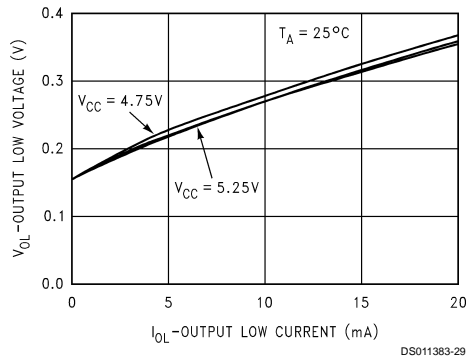

Receiver  $V_{OL}$  vs  $I_{OL}$  vs Temperature

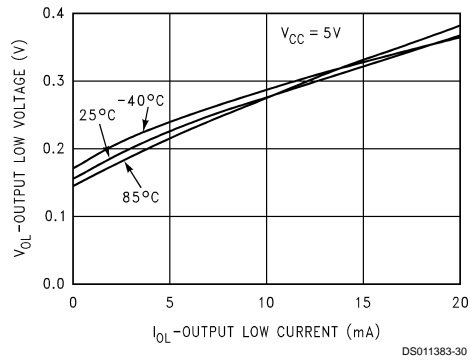

Supply Current vs Supply Voltage

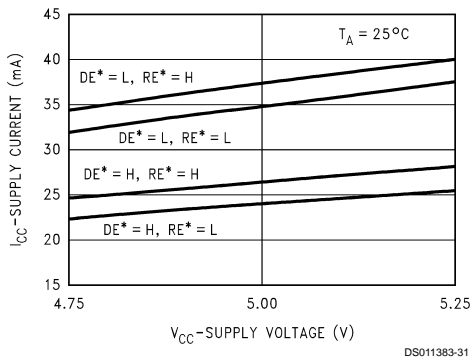

Supply Current vs Temperature

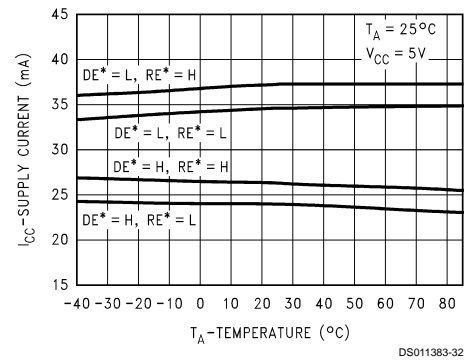

## Typical Performance Characteristics (Continued)

### Voltage Output vs Voltage Input (Hysteresis)

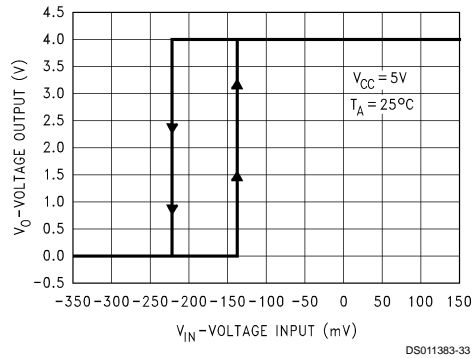



**Physical Dimensions** inches (millimeters) unless otherwise noted

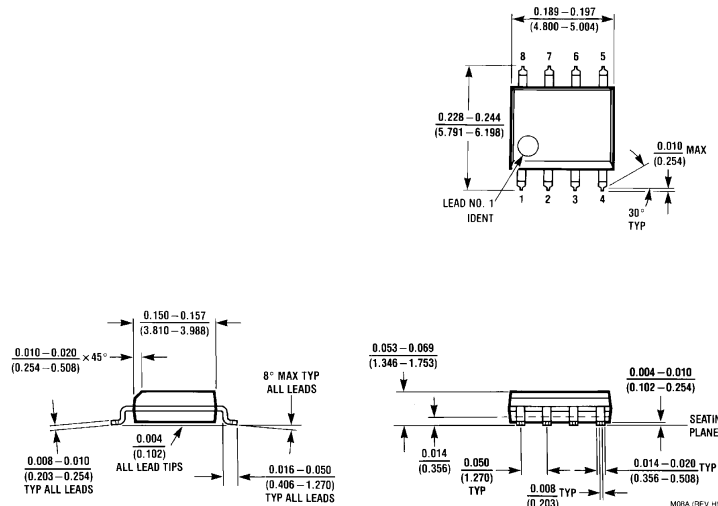

Order Number DS36276M  
NS Package Number M08A

**LIFE SUPPORT POLICY**

NATIONAL'S PRODUCTS ARE NOT AUTHORIZED FOR USE AS CRITICAL COMPONENTS IN LIFE SUPPORT DEVICES OR SYSTEMS WITHOUT THE EXPRESS WRITTEN APPROVAL OF THE PRESIDENT OF NATIONAL SEMICONDUCTOR CORPORATION. As used herein:

1. Life support devices or systems are devices or systems which, (a) are intended for surgical implant into the body, or (b) support or sustain life, and whose failure to perform when properly used in accordance with instructions for use provided in the labeling, can be reasonably expected to result in a significant injury to the user.
2. A critical component is any component of a life support device or system whose failure to perform can be reasonably expected to cause the failure of the life support device or system, or to affect its safety or effectiveness.

 **National Semiconductor Corporation**  
Americas  
Tel: 1-800-272-9959  
Fax: 1-800-737-7018  
Email: support@nsc.com

**National Semiconductor Europe**  
Fax: +49 (0) 1 80-530 85 86  
Email: europe.support@nsc.com  
Deutsch Tel: +49 (0) 1 80-530 85 85  
English Tel: +49 (0) 1 80-532 78 32  
Français Tel: +49 (0) 1 80-532 93 58  
Italiano Tel: +49 (0) 1 80-534 16 80

**National Semiconductor Asia Pacific Customer Response Group**  
Tel: 65-2544466  
Fax: 65-2504466  
Email: sea.support@nsc.com

**National Semiconductor Japan Ltd.**  
Tel: 81-3-5639-7560  
Fax: 81-3-5639-7507

www.national.com

[Products](#) > [Analog - Interface](#) > [Data Transmission Circuits](#) > [RS-485](#) > DS36276

Product Folder

## DS36276 FailSafe Multipoint Transceiver

### Contents

- [General Description](#)
- [Features](#)
- [Datasheet](#)
- [Package Availability, Models, Samples & Pricing](#)
- [Application Notes](#)

Parametric Table	
Number of Drivers	1
Number of Receivers	1
Supply Voltage	5 V
Process	Bipolar

### General Description

The DS36276 FAILSAFE Multipoint Transceiver is designed for use on bi-directional differential busses. It is compatible with existing TIA/EIA-485 transceivers, however, it offers an additional feature not supported by standard transceivers.

The FAILSAFE feature guarantees the receiver output to a known state when the Interface is in the following conditions: Floating Line, Idle Line (no active drivers), and Line Fault conditions (open or short). The receiver output is in a HIGH state for the following conditions: OPEN Inputs, Terminated Inputs (50 Ohm), and SHORTED Inputs.

FAILSAFE is a highly desirable feature when the transceivers are used with Asynchronous Controllers such as UARTs.

### Features

- FAILSAFE receiver, RO = HIGH for:
  - OPEN inputs
  - Terminated inputs
  - SHORTED inputs
- Compatible with popular interface standards:
  - TIA/EIA-485 (RS-485)
  - TIA/EIA-422-A (RS-422-A)
  - CCITT Recommendation V.11
- Bi-Directional Transceiver
  - Designed for multipoint transmission

- Separate driver input, driver enable, receiver enable, and receiver output for maximum flexibility
- Wide bus common mode range
  - (-7V to +12V)
- Pin compatible with: DS75176B, DS96176, DS3695 and SN75176A and B
- Available in SOIC package

## Datasheet

Title	Size (in Kbytes)	Date	<input type="checkbox"/> View Online	<input type="checkbox"/> Download	<input type="checkbox"/> Receive via Email
DS36276 FAILSAFE Multipoint Transceiver	236 Kbytes	4-Mar-99	<a href="#">View Online</a>	<a href="#">Download</a>	<a href="#">Receive via Email</a>
DS36276 FAILSAFE Multipoint Transceiver (JAPANESE)	431 Kbytes		<input type="checkbox"/> View Online	<input type="checkbox"/> Download	<input type="checkbox"/> Receive via Email

Please use [Adobe Acrobat](#) to view PDF file(s).

If you have trouble printing, see [Printing Problems](#).

## Package Availability, Models, Samples & Pricing

Part Number	Package		Status	Models		Samples & Electronic Orders	Budgetary Pricing		Std Pack Size	<a href="#">Package Marking</a>
	Type	# pins		SPICE	IBIS		Quantity	\$US each		
DS36276M	<a href="#">SOIC NARROW</a>	8	Full production	N/A	N/A	<input type="checkbox"/> 24 Hour Samples <input type="checkbox"/> Buy Now	1K+	\$1.3400	tube of 95	[logo]¢2¢T DS36 276M
DS36276MX	<a href="#">SOIC NARROW</a>	8	Full production	N/A	N/A		1K+	\$1.3400	reel of 2500	[logo]¢2¢T DS36 276M
DS36276 MDC	<a href="#">Die</a>		Full production	N/A	N/A				tray of N/A	-

## Application Notes

Title	Size (in Kbytes)	Date	<input type="checkbox"/> View Online	<input type="checkbox"/> Download	<input type="checkbox"/> Receive via Email
AN-1057: Application Note 1057 Ten Ways to Bulletproof RS-485 Interfaces	155 Kbytes	5-Oct-98	<a href="#">View Online</a>	<a href="#">Download</a>	<a href="#">Receive via Email</a>
AN-1031: Application Note 1031 TIA/EIA-422-B Overview	101 Kbytes	3-Feb-00	<a href="#">View Online</a>	<a href="#">Download</a>	<a href="#">Receive via Email</a>

Please use [Adobe Acrobat](#) to view PDF file(s).

If you have trouble printing, see [Printing Problems](#).

---

*[Information as of 3-Oct-2001]*

---

**Quick Search**

[Parametric  
Search](#)

[System  
Diagrams](#)

[Product  
Tree](#)

[Home](#)

[About Languages](#) . [Website Guide](#) . [About "Cookies"](#) . National is [QS 9000 Certified](#)  
[Site Terms & Conditions of Use](#) . Copyright 2001 © National Semiconductor Corporation  
[Privacy/Security Statement](#) .  [Preferences](#) . [Feedback](#)