



FPF1504 / FPF1504L Advanced Load Management Switch

Features

- 1.0 V to 3.6 V Input Voltage Operating Range
- Typical $R_{DS(ON)}$:
 - 15 m Ω at $V_{IN}=3.3$ V
 - 20 m Ω at $V_{IN}=1.8$ V
 - 55 m Ω at $V_{IN}=1.0$ V
- Slew Rate Control
- Output Discharge Function
- Low <1 μ A Quiescent Current at $V_{ON}=V_{IN}$
- ESD Protected: 4000 V HBM, 2000 V CDM
- GPIO/CMOS-Compatible Enable Circuitry
- Active HIGH and active LOW versions

Applications

- Mobile Devices and Smart Phones
- Portable Media Devices
- Digital Cameras
- Advanced Notebook, UMPC, and MID
- Portable Medical Devices
- GPS and Navigation Equipment

Description

The FPF1504/FPF1504L are low- R_{DS} P-channel MOSFET load switches of the IntelliMAX™ family. Integrated slew-rate control prevents excessive inrush current from the supply rails with capacitive loads common in power applications. In addition, the FPF1504/FPF1504L feature output discharge capability.

The input voltage range operates from 1.0 V to 3.6 V to fulfill today's mobile device supply requirements. Switch control is by a logic input (ON pin) capable of interfacing directly with low-voltage CMOS control signals and GPIOs in embedded processors.

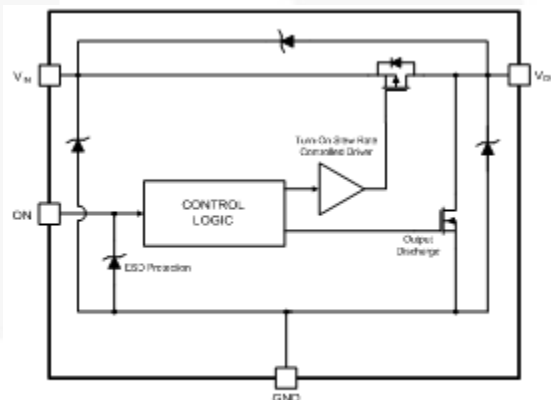

Figure 1. Block Diagram

Ordering Information

Part Number	Top Mark	Switch (Typical) At 1.8 V _{IN}	Input Buffer	Output Discharge	ON Pin Activity	Package
FPF1504UCX	G4	20 m Ω	CMOS	YES	Active HIGH	4-Ball, WLCSP, 0.5 mm Pitch
FPF1504BUCX	G4	20 m Ω	CMOS	YES	Active HIGH	4-Ball, WLCSP with Backside Laminate, 0.5 mm Pitch
FPF1504LUCX	GZ	20 m Ω	CMOS	YES	Active LOW	4-Ball, WLCSP, 0.5 mm Pitch

Application Diagram

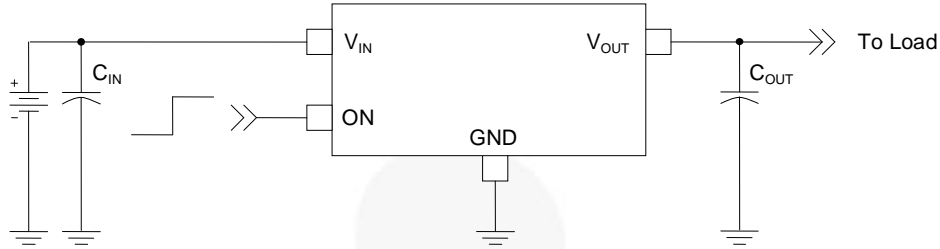

Figure 2. Typical Application

Notes:

1. $C_{IN}=1\ \mu\text{F}$, X5R, 0603, for example Murata GRM185R60J105KE26.
2. $C_{OUT}=1\ \mu\text{F}$, X5R, 0805, for example Murata GRM216R61A105KA01.

Pin Configurations

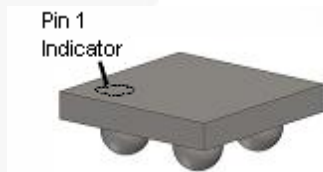

Figure 3. 1 x 1 mm WLCSP Bumps Facing Down

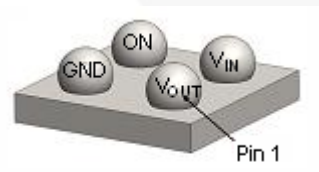

Figure 4. 1 x 1 mm WLCSP Bumps Facing Up

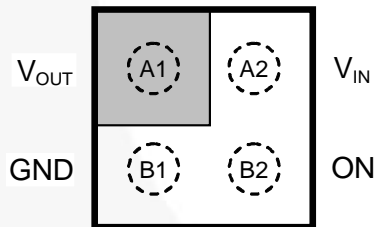

Figure 5. Pin Assignments (Top View)

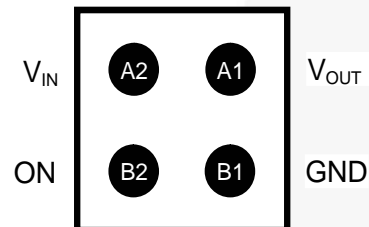

Figure 6. Pin Assignments (Bottom View)

Pin Definitions

Pin #	Name	Description
A1	V_{OUT}	Switch Output
A2	V_{IN}	Supply Input; Input to the Power Switch
B1	GND	Ground
B2	ON	ON/OFF Control

Absolute Maximum Ratings

Stresses exceeding the absolute maximum ratings may damage the device. The device may not function or be operable above the recommended operating conditions and stressing the parts to these levels is not recommended. In addition, extended exposure to stresses above the recommended operating conditions may affect device reliability. The absolute maximum ratings are stress ratings only.

Symbol	Parameter	Min.	Max.	Unit
V_{IN}	V_{IN} , V_{OUT} , V_{ON} to GND	-0.3	4.0	V
I_{SW}	Maximum Continuous Switch Current		1.5	A
P_D	Power Dissipation at $T_A=25^\circ\text{C}$		1.0	W
T_{STG}	Storage Junction Temperature	-65	+150	$^\circ\text{C}$
T_A	Operating Temperature Range	-40	+85	$^\circ\text{C}$
Θ_{JA}	Thermal Resistance, Junction-to-Ambient	1S2P with 1 Thermal Via	95	$^\circ\text{C}/\text{W}$
		1S2P without Thermal Via	187	
ESD	Electrostatic Discharge Capability	Human Body Model, JESD22-A114	4	kV
		Charged Device Model, JESD22-C101	2	

Recommended Operating Conditions

The Recommended Operating Conditions table defines the conditions for actual device operation. Recommended operating conditions are specified to ensure optimal performance to the datasheet specifications. Fairchild does not recommend exceeding them or designing to Absolute Maximum Ratings.

Symbol	Parameter	Min.	Max.	Unit
V_{IN}	Supply Voltage	1.0	3.6	V
T_A	Ambient Operating Temperature	-40	+85	$^\circ\text{C}$

Electrical Characteristics

Unless otherwise noted, $V_{IN}=1.0$ to 3.6 V, $T_A=-40$ to $+85^\circ\text{C}$; typical values are at $V_{IN}=3.3$ V and $T_A=25^\circ\text{C}$.

Symbol	Parameter		Conditions	Min.	Typ.	Max.	Units	
Basic Operation								
V_{IN}	Supply Voltage			1.0		3.6	V	
$I_{Q(OFF)}$	Off Supply Current	FPF1504	$V_{ON}=\text{GND}, V_{OUT}=\text{Open}$		0.25		μA	
		FPF1504L	$V_{ON}=V_{IN}, V_{OUT}=\text{Open}$		0.3			
$I_{SD(OFF)}$	Off Switch Current	FPF1504	$V_{ON}=\text{GND}, V_{OUT}=\text{GND}$		0.25			
		FPF1504L	$V_{ON}=V_{IN}, V_{OUT}=\text{GND}$		0.3			
I_Q	Quiescent Current	FPF1504	$I_{OUT}=0$ mA, $V_{IN}=3.6$ V, $V_{ON}=V_{IN}$		0.08			
			$I_{OUT}=0$ mA, $V_{ON}=V_{IH(MIN)}$		0.75			
		FPF1504L	$I_{OUT}=0$ mA, $V_{IN}=3.6$ V, $V_{ON}=\text{GND}$		0.08			
			$I_{OUT}=0$ mA, $V_{ON}=V_{IL(MAX)}$		0.95			
R_{ON}	On Resistance	$V_{IN}=3.3$ V, $I_{OUT}=200$ mA, $T_A=25^\circ\text{C}$			15	30	m Ω	
		$V_{IN}=1.8$ V, $I_{OUT}=200$ mA, $T_A=25^\circ\text{C}$			20	40		
		$V_{IN}=1.5$ V, $I_{OUT}=200$ mA, $T_A=25^\circ\text{C}$			30			
		$V_{IN}=1.0$ V, $I_{OUT}=200$ mA, $T_A=25^\circ\text{C}$			40	80		
		$V_{IN}=1.8$ V, $I_{OUT}=200$ mA, $T_A=85^\circ\text{C}^{(3)}$			35	50		
R_{PD}	Output Discharge Pull-Down Resistance		$V_{ON}=0$ V or V_{IN} , $I_{OUT}=-20$ mA		65	95	Ω	
V_{IH}	On Input Logic High Voltage	FPF1504		0.8			V	
V_{IL}	On Input Logic Low Voltage	FPF1504				0.3		
I_{ON}	On Input Leakage		$V_{ON}=V_{IN}$ or GND			1	μA	
Dynamic Characteristics								
t_{DON}	Turn-On Delay ⁽⁴⁾	FPF1504	$R_L=10$ Ω , $C_L=0.1$ μF , $V_{IN}=3.3$ V, $T_A=25^\circ\text{C}$		80		μs	
t_R	V_{OUT} Rise Time ⁽⁴⁾	FPF1504				130		
t_{ON}	Turn-On Time ⁽⁴⁾	FPF1504				210		
t_{DON}	Turn-On Delay ⁽⁴⁾	FPF1504	$R_L=500$ Ω , $C_L=0.1$ μF , $V_{IN}=3.3$ V, $T_A=25^\circ\text{C}$		70	100	μs	
		FPF1504L				95		
t_R	V_{OUT} Rise Time ⁽⁴⁾	FPF1504				110		150
		FPF1504L				115		
t_{ON}	Turn-On Time ⁽⁴⁾	FPF1504				180		250
		FPF1504L				210		

Continued on the following page...

Electrical Characteristics (Continued)

Unless otherwise noted, $V_{IN}=1.0$ to 3.6 V, $T_A=-40$ to $+85^\circ\text{C}$; typical values are at $V_{IN}=3.3$ V and $T_A=25^\circ\text{C}$.

Symbol	Parameter	Conditions	Min.	Typ.	Max.	Units
Dynamic Characteristics (Continued)						
t_{DOFF}	Turn-Off Delay ⁽⁴⁾	FPF1504		25	30	μs
t_F	V_{OUT} Fall Time ⁽⁴⁾	FPF1504	$R_L=10\ \Omega$, $C_L=0.1\ \mu\text{F}$, $V_{IN}=3.3\ \text{V}$, $T_A=25^\circ\text{C}$	2		
t_{OFF}	Turn-Off Time ⁽⁴⁾	FPF1504		27		
t_{DOFF}	Turn-Off Delay ⁽⁴⁾	FPF1504 FPF1504L			25 2	
t_F	V_{OUT} Fall Time ⁽⁴⁾	FPF1504 FPF1504L	$R_L=500\ \Omega$, $C_L=0.1\ \mu\text{F}$, $V_{IN}=3.3\ \text{V}$, $T_A=25^\circ\text{C}$	12 14		
t_{OFF}	Turn-Off Time ⁽⁴⁾	FPF1504 FPF1504L		37 16		

Notes:

3. This parameter is guaranteed by design and characterization; not production tested.
4. $t_{DON}/t_{DOFF}/t_R/t_F$ are defined in Figure 7.
5. Output discharge path is enabled during off.

Timing Diagram – FPF1504

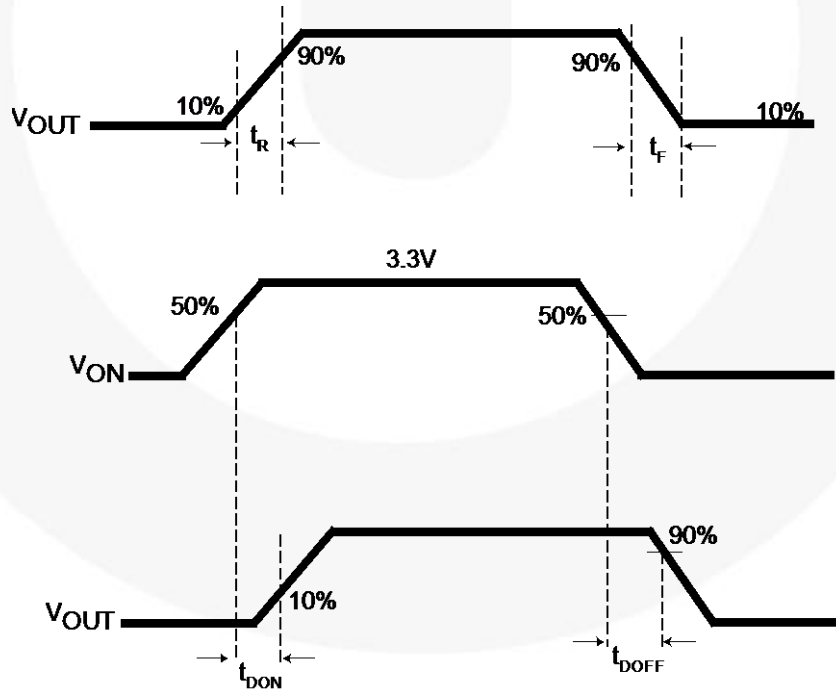

Notes:

6. $t_{ON}=t_R + t_{DON}$.
7. $t_{OFF}=t_F + t_{DOFF}$.

Figure 7. Timing Diagram for FPF1504

Typical Performance Characteristics for FPF1504

Applicable to active high version only.

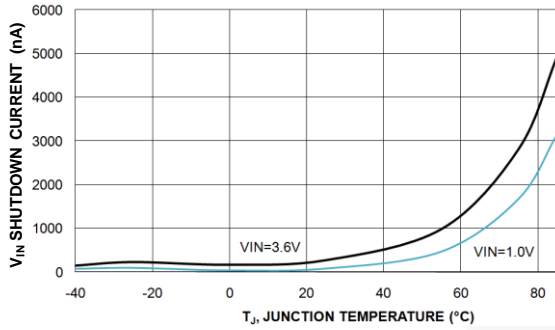

Figure 8. Shutdown Current vs. Temperature

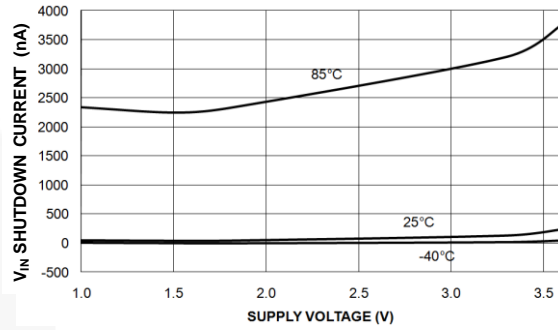

Figure 9. Shutdown Current vs. Supply Voltage

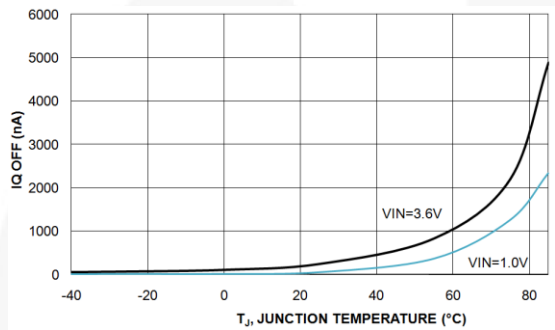

Figure 10. Off Supply Current vs. Temperature

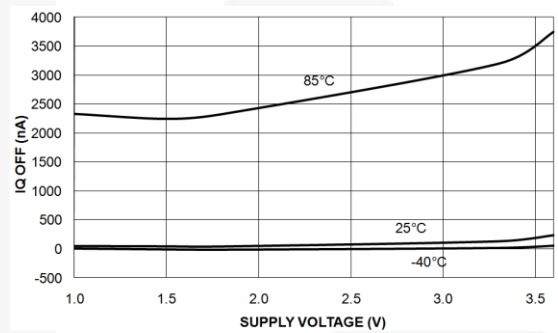

Figure 11. Off Supply Current vs. Supply Voltage

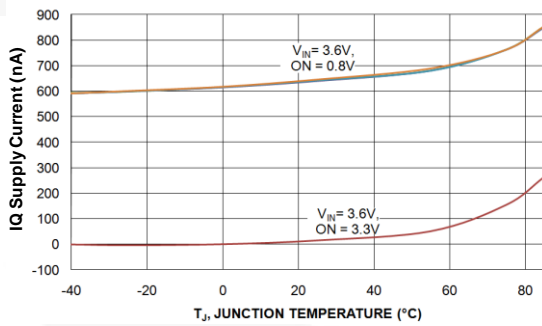

Figure 12. Quiescent Current vs. Temperature

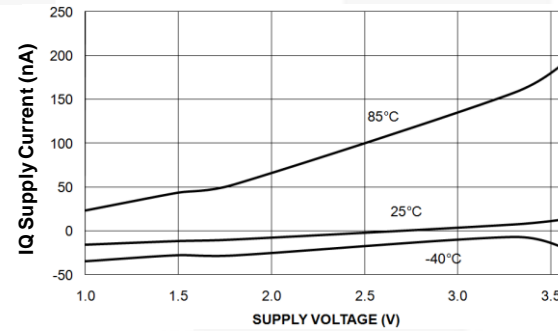

Figure 13. Quiescent Current vs. Supply Voltage (V_{ON}=V_{IN})

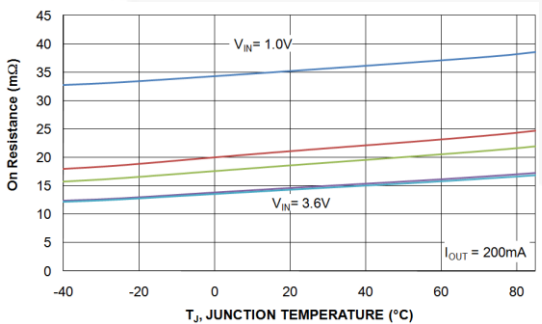

Figure 14. R_{ON} vs. Temperature

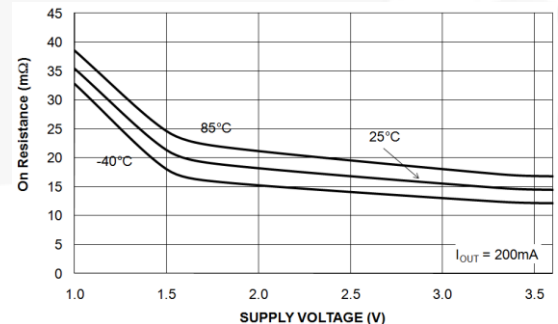

Figure 15. R_{ON} vs. Supply Voltage

Typical Performance Characteristics for FPF1504

Applicable to active high version only.

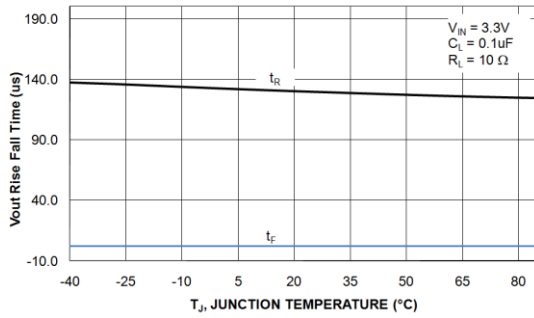

Figure 16. V_{OUT} Rise/Fall Times vs. Temperature ($R_L=10\ \Omega$)

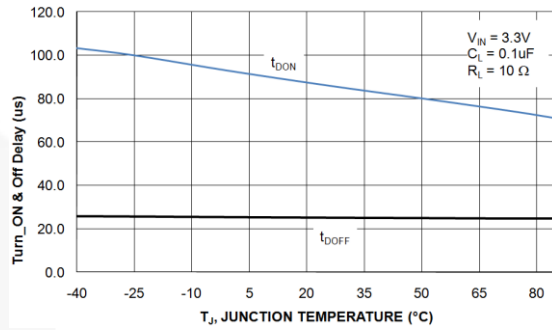

Figure 17. V_{OUT} Turn-On/Turn-Off Delays vs. Temperature ($R_L=10\ \Omega$)

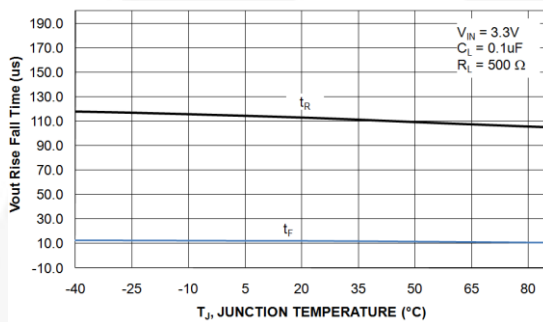

Figure 18. V_{OUT} Rise/Fall Time vs. Temperature ($R_L=500\ \Omega$)

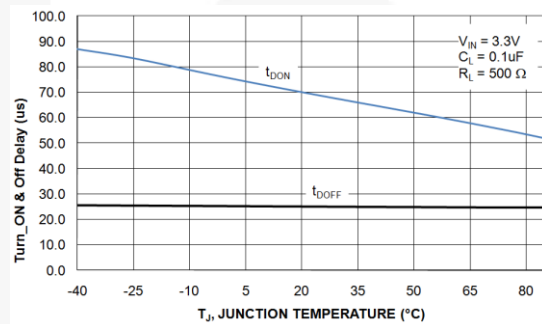

Figure 19. V_{OUT} Turn-On/Turn-Off Delays vs. Temperature ($R_L=500\ \Omega$)

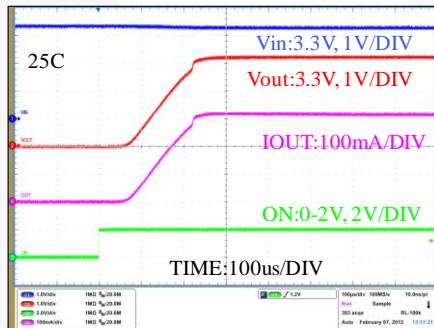

Figure 20. Turn-On Response ($V_{IN}=3.3\ \text{V}$, $C_{OUT}=0.1\ \mu\text{F}$, $R_L=10\ \Omega$)

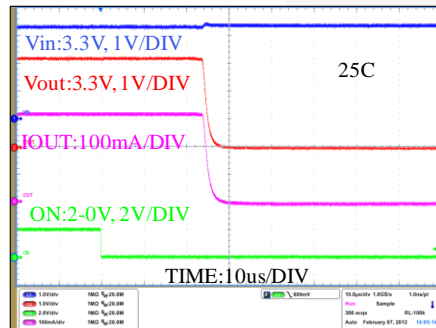

Figure 21. Turn-Off Response ($V_{IN}=3.3\ \text{V}$, $C_{OUT}=0.1\ \mu\text{F}$, $R_L=10\ \Omega$)

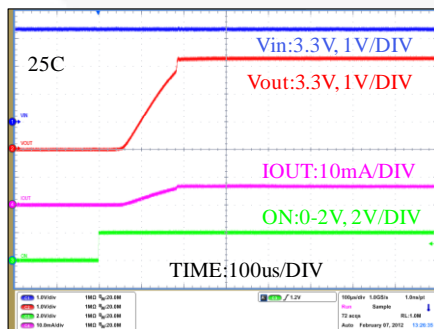

Figure 22. Turn-On Response ($V_{IN}=3.3\ \text{V}$, $C_{OUT}=0.1\ \mu\text{F}$, $R_L=500\ \Omega$)

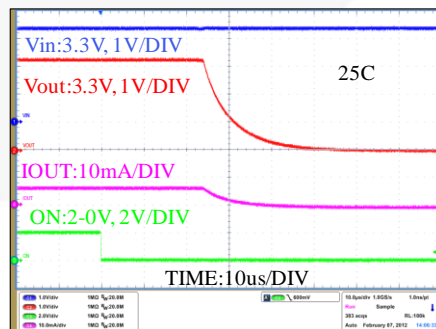

Figure 23. Turn-Off Response ($V_{IN}=3.3\ \text{V}$, $C_{OUT}=0.1\ \mu\text{F}$, $R_L=500\ \Omega$)

Application Information

Input Capacitor

IntelliMAX™ switches don't require an input capacitor. To reduce device inrush current, a 0.1 μF ceramic capacitor, C_{IN}, is recommended close to the VIN pin. A higher value of C_{IN} can be used to further reduce the voltage drop experienced as the switch is turned on into a large capacitive load.

Output Capacitor

IntelliMAX™ switches work without an output capacitor. If the applications parasitic board inductance forces V_{OUT} below GND when switching off, a 0.1 μF capacitor, C_{OUT}, should be placed between V_{OUT} and GND.

Fall Time

Device output fall time can be calculated based on RC constant of external components as follows:

$$t_F = R_L \times C_L \times 2.2 \quad (1)$$

where t_F is 90% to 10% fall time, R_L is output load, load and C_L is output capacitor.

The same equation works for a device with a pull-down output resistor, then R_L is replaced by a parallel connected pull-down and external output resistor combination, as follows:

$$t_F = \frac{R_L \times R_{PD}}{R_L + R_{PD}} \times C_L \times 2.2 \quad (2)$$

where t_F is 90% to 10% fall time, R_L is output load, R_{PD} is output pull-down resistor (65 Ω typical), and C_L is the output capacitor.

Recommended Land Pattern and Layout

For best thermal performance and minimal inductance and parasitic effects, it is recommended to keep input and output traces short and the capacitors as close to

the device as possible. Below is a recommended layout for this device to achieve optimum performance.

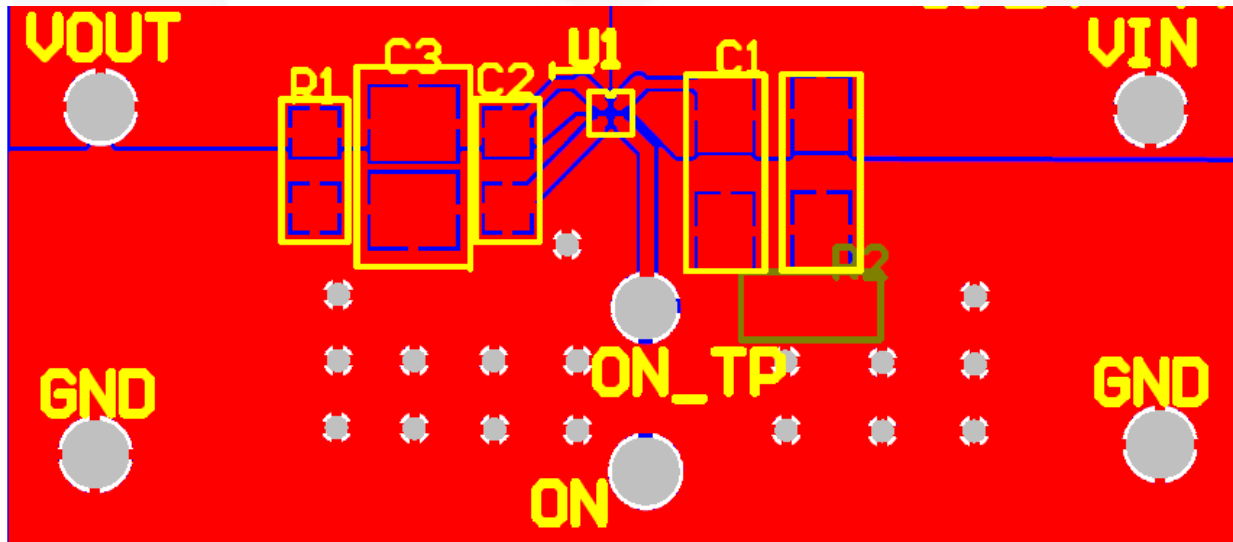
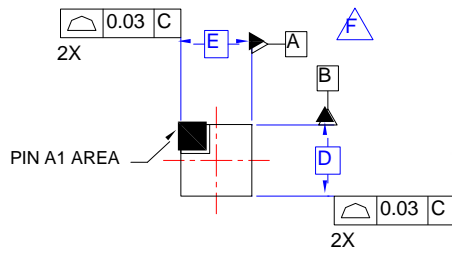
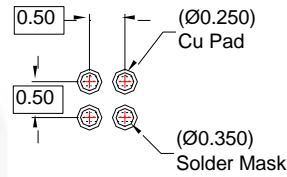

Figure 24. Recommended Land Pattern and Layout

Physical Dimensions



TOP VIEW



RECOMMENDED LAND PATTERN
(NSMD PAD TYPE)

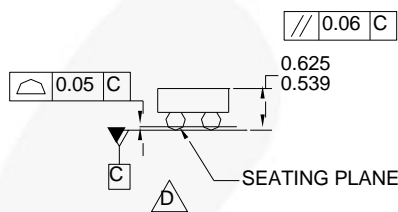

SIDE VIEWS

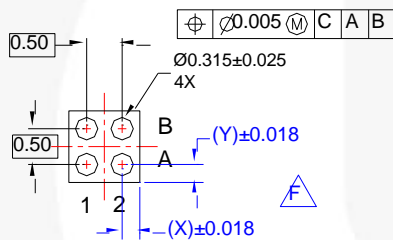
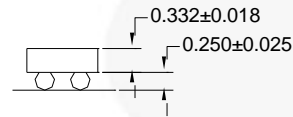

BOTTOM VIEW

NOTES:

- A. NO JEDEC REGISTRATION APPLIES.
- B. DIMENSIONS ARE IN MILLIMETERS.
- C. DIMENSIONS AND TOLERANCES PER ASME Y14.5M, 1994.
- D. DATUM C IS DEFINED BY THE SPHERICAL CROWNS OF THE BALLS.
- E. PACKAGE NOMINAL HEIGHT IS 582 MICRONS ±43 MICRONS (539-625 MICRONS).
- F. FOR DIMENSIONS D, E, X, AND Y SEE PRODUCT DATASHEET.
- G. DRAWING FILENAME: MKT-UC004ABrev2.

Figure 25. 4-Ball, 1.0 x 1.0 mm Wafer-Level Chip Scale (WLCSP) Packaging

Product-Specific Dimensions

Product	D	E	X	Y
FPF1504UCX	960 µm ±30 µm	960 µm ±30 µm	0.230 mm	0.230 mm
FPF1504BUCX				
FPF1504LUCX				



Package drawings are provided as a service to customers considering Fairchild components. Drawings may change in any manner without notice. Please note the revision and/or date on the drawing and contact a Fairchild Semiconductor representative to verify or obtain the most recent revision. Package specifications do not expand the terms of Fairchild's worldwide terms and conditions, specifically the warranty therein, which covers Fairchild products.

Always visit Fairchild Semiconductor's online packaging area for the most recent package drawings:
<http://www.fairchildsemi.com/dwg/UC/UC004AB.pdf>.



TRADEMARKS

The following includes registered and unregistered trademarks and service marks, owned by Fairchild Semiconductor and/or its global subsidiaries, and is not intended to be an exhaustive list of all such trademarks.

- | | | | |
|--|--|---------------------------------------|---|
| AccuPower™ | F-PFS™ | PowerTrench® | Sync-Lock™ |
| AX-CAP®* | FRFET® | PowerXS™ | SYSTEM GENERAL® |
| BitSiC™ | Global Power Resource™ | Programmable Active Droop™ | TinyBoost® |
| Build it Now™ | GreenBridge™ | QFET® | TinyBuck® |
| CorePLUS™ | Green FPS™ | QS™ | TinyCalc™ |
| CorePOWER™ | Green FPS™ e-Series™ | Quiet Series™ | TinyLogic® |
| CROSSVOLT™ | Gmax™ | RapidConfigure™ | TINYOPTO™ |
| CTL™ | GTO™ | Saving our world, 1mW/W/kW at a time™ | TinyPower™ |
| Current Transfer Logic™ | IntelliMAX™ | SignalWise™ | TinyPWM™ |
| DEUXPEED® | ISOPLANAR™ | SmartMax™ | TinyWire™ |
| Dual Cool™ | Making Small Speakers Sound Louder and Better™ | SMART START™ | TranSiC™ |
| EcoSPARK® | MegaBuck™ | Solutions for Your Success™ | TriFault Detect™ |
| EfficientMax™ | MICROCOUPLER™ | SPM® | TRUECURRENT®* |
| ESBC™ | MicroFET™ | STEALTH™ | µSerDes™ |
|  Fairchild® | MicroPak™ | SuperFET® |  SerDes™ |
| Fairchild Semiconductor® | MicroPak2™ | SuperSOT™-3 | UHC™ |
| FACT Quiet Series™ | MillerDrive™ | SuperSOT™-6 | Ultra FRFET™ |
| FACT® | MotionMax™ | SuperSOT™-8 | UniFET™ |
| FAST® | mWSaver® | SupreMOS® | VCX™ |
| FastvCore™ | OptoHiT™ | SyncFET™ | VisualMax™ |
| FETBench™ | OPTOLOGIC® | | VoltagePlus™ |
| FPS™ | OPTOPLANAR® | | XS™ |

* Trademarks of System General Corporation, used under license by Fairchild Semiconductor.

DISCLAIMER

FAIRCHILD SEMICONDUCTOR RESERVES THE RIGHT TO MAKE CHANGES WITHOUT FURTHER NOTICE TO ANY PRODUCTS HEREIN TO IMPROVE RELIABILITY, FUNCTION, OR DESIGN. FAIRCHILD DOES NOT ASSUME ANY LIABILITY ARISING OUT OF THE APPLICATION OR USE OF ANY PRODUCT OR CIRCUIT DESCRIBED HEREIN; NEITHER DOES IT CONVEY ANY LICENSE UNDER ITS PATENT RIGHTS, NOR THE RIGHTS OF OTHERS. THESE SPECIFICATIONS DO NOT EXPAND THE TERMS OF FAIRCHILD'S WORLDWIDE TERMS AND CONDITIONS, SPECIFICALLY THE WARRANTY THEREIN, WHICH COVERS THESE PRODUCTS.

LIFE SUPPORT POLICY

FAIRCHILD'S PRODUCTS ARE NOT AUTHORIZED FOR USE AS CRITICAL COMPONENTS IN LIFE SUPPORT DEVICES OR SYSTEMS WITHOUT THE EXPRESS WRITTEN APPROVAL OF FAIRCHILD SEMICONDUCTOR CORPORATION.

As used herein:

1. Life support devices or systems are devices or systems which, (a) are intended for surgical implant into the body or (b) support or sustain life, and (c) whose failure to perform when properly used in accordance with instructions for use provided in the labeling, can be reasonably expected to result in a significant injury of the user.
2. A critical component in any component of a life support, device, or system whose failure to perform can be reasonably expected to cause the failure of the life support device or system, or to affect its safety or effectiveness.

ANTI-COUNTERFEITING POLICY

Fairchild Semiconductor Corporation's Anti-Counterfeiting Policy. Fairchild's Anti-Counterfeiting Policy is also stated on our external website, www.fairchildsemi.com, under Sales Support.

Counterfeiting of semiconductor parts is a growing problem in the industry. All manufacturers of semiconductor products are experiencing counterfeiting of their parts. Customers who inadvertently purchase counterfeit parts experience many problems such as loss of brand reputation, substandard performance, failed applications, and increased cost of production and manufacturing delays. Fairchild is taking strong measures to protect ourselves and our customers from the proliferation of counterfeit parts. Fairchild strongly encourages customers to purchase Fairchild parts either directly from Fairchild or from Authorized Fairchild Distributors who are listed by country on our web page cited above. Products customers buy either from Fairchild directly or from Authorized Fairchild Distributors are genuine parts, have full traceability, meet Fairchild's quality standards for handling and storage and provide access to Fairchild's full range of up-to-date technical and product information. Fairchild and our Authorized Distributors will stand behind all warranties and will appropriately address any warranty issues that may arise. Fairchild will not provide any warranty coverage or other assistance for parts bought from Unauthorized Sources. Fairchild is committed to combat this global problem and encourage our customers to do their part in stopping this practice by buying direct or from authorized distributors.

PRODUCT STATUS DEFINITIONS

Definition of Terms

Datasheet Identification	Product Status	Definition
Advance Information	Formative / In Design	Datasheet contains the design specifications for product development. Specifications may change in any manner without notice.
Preliminary	First Production	Datasheet contains preliminary data; supplementary data will be published at a later date. Fairchild Semiconductor reserves the right to make changes at any time without notice to improve design.
No Identification Needed	Full Production	Datasheet contains final specifications. Fairchild Semiconductor reserves the right to make changes at any time without notice to improve the design.
Obsolete	Not In Production	Datasheet contains specifications on a product that is discontinued by Fairchild Semiconductor. The datasheet is for reference information only.

Rev. I66