

T-46-07-11



54FCT377/74FCT377

Octal D Flip-Flop with Clock Enable

General Description

The FCT377 has eight edge-triggered, D-type flip-flops with individual D inputs and Q outputs. The common buffered Clock (CP) input loads all flip-flops simultaneously, when the Clock Enable (CE) is LOW.

The register is fully edge-triggered. The state of each D input, one setup time before the LOW-to-HIGH clock transition, is transferred to the corresponding flip-flop's Q output. The CE input must be stable only one setup time prior to the LOW-to-HIGH clock transition for predictable operation.

FACT™ FCT utilizes NSC quiet series technology to provide improved quiet output switching and dynamic threshold performance.

FACT FCT features GTO™ output control and undershoot corrector in addition to a split ground bus for superior performance.

Features

- I_{CC} reduced to 40.0 μA
- NSC 54FCT/74FCT377 is pin and functionally equivalent to IDT 54FCT/74FCT377
- Ideal for addressable register applications
- Clock enables for address and data synchronization applications
- Input clamp diodes to limit bus reflections
- TTL/CMOS input and output level compatible
- I_{OL} = 48 mA (com), 48 mA (mil)
- CMOS power levels
- ESD immunity ≥ 4 kV typ
- Military product compliant to MIL-STD 883 and Standard Military Drawing # 5962-87627

Ordering Code: See Section 8

Logic Symbols

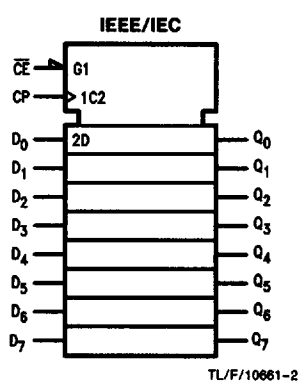
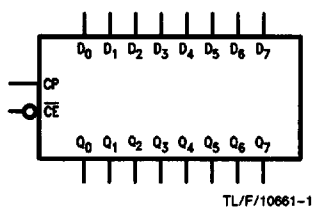

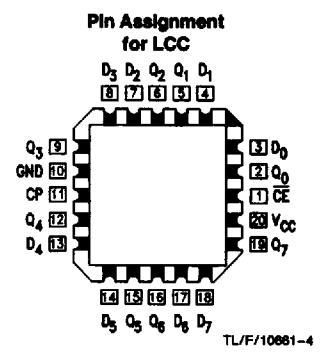
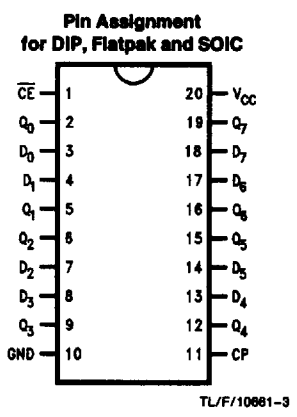

Connection Diagrams



Pin Names	Description
D ₀ -D ₇	Data Inputs
CE	Clock Enable (Active LOW)
Q ₀ -Q ₇	Data Outputs
CP	Clock Pulse Input

377

Mode Select-Function Table

Operating Mode	Inputs			Outputs
	CP	\overline{CE}	D_n	Q_n
Load '1'		L	H	H
Load '0'		L	L	L
Hold (Do Nothing)		H	X	No Change
	X	H	X	No Change

H = HIGH Voltage Level
 L = LOW Voltage Level
 X = Immaterial
 = LOW-to-HIGH Clock Transition

Logic Diagram

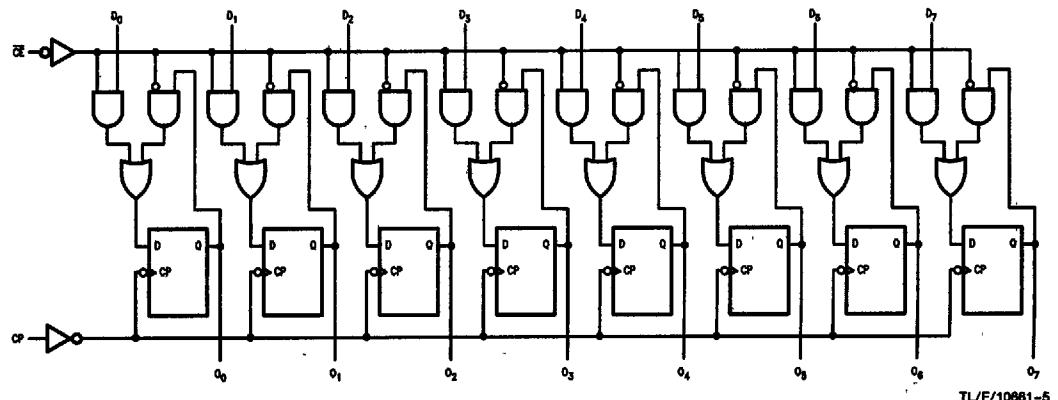

TL/F/10661-5

Please note that this diagram is provided only for the understanding of logic operations and should not be used to estimate propagation delays.

Absolute Maximum Ratings (Note 1)

If Military/Aerospace specified devices are required, please contact the National Semiconductor Sales Office/Distributors for availability and specifications.

Terminal Voltage with Respect to GND	
(V _{TERM})	
54FCT	-0.5V to +7.0V
74FCT	-0.5V to +7.0V
Temperature Under Bias (T _{BIAS})	
74FCT	-55°C to +125°C
54FCT	-65°C to +135°C
Storage Temperature (T _{STG})	
74FCT	-55°C to +125°C
54FCT	-65°C to +150°C
DC Output Current (I _{OUT})	120 mA

Note 1: Absolute maximum ratings are those values beyond which damage to the device may occur. Exposure to absolute maximum rating conditions for extended periods may affect reliability. The databook specifications should be met, without exception, to ensure that the system design is reliable over its power supply, temperature, and output/input loading variables.

Recommended Operating Conditions

Supply Voltage (V _{CC})	
54FCT	4.5V to 5.5V
74FCT	4.75V to 5.25V
Input Voltage	0V to V _{CC}
Output Voltage	0V to V _{CC}
Operating Temperature (T _A)	
54FCT	-55°C to +125°C
74FCT	-0°C to +70°C
Junction Temperature (T _J)	
CDIP	175°C
PDIP	140°C

Note: All commercial packaging is not recommended for applications requiring greater than 2000 temperature cycles from -40°C to +125°C.

DC Characteristics for 'FCT Family Devices

Typical values are at V_{CC} = 5.0V, 25°C ambient and maximum loading. For test conditions shown as Max, use the value specified for the appropriate device type: Com: V_{CC} = 5.0V ± 5%, T_A = 0°C to +70°C; Mil: V_{CC} = 5.0V ± 10%, T_A = -55°C to +125°C, V_{HC} = V_{CC} - 0.2V.

Symbol	Parameter	54FCT/74FCT			Units	Conditions	
		Min	Typ	Max			
V _{IH}	Minimum High Level Input Voltage	2.0			V		
V _{IL}	Maximum Low Level Input Voltage			0.8	V		
I _{IH}	Input High Current			5.0 5.0	μA	V _{CC} = Max	V _I = V _{CC} V _I = 2.7V (Note 2)
I _{IL}	Input Low Current			-5.0 -5.0	μA	V _{CC} = Max	V _I = 0.5V (Note 2) V _I = GND
V _{IK}	Clamp Diode Voltage	-0.7	-1.2		V	V _{CC} = Min; I _N = -18 mA	
I _{OS}	Short Circuit Current	-60	-120		mA	V _{CC} = Max (Note 1); V _O = GND	
V _{OH}	Minimum High Level Output Voltage	2.8	3.0		V	V _{CC} = 3V; V _{IN} = 0.2V or V _{HC} ; I _{OH} = -32 μA	
		V _{HC}	V _{CC}			V _{CC} = Min	I _{OH} = -300 μA
		2.4	4.3			V _{IN} = V _{IH} or V _{IL}	I _{OH} = -12 mA (Mil)
		2.4	4.3				I _{OH} = -15 mA (Com)
V _{OL}	Maximum Low Level Output Voltage		GND	0.2	V	V _{CC} = 3V; V _{IN} = 0.2V or V _{HC} ; I _{OL} = 300 μA	
			GND	0.2		V _{CC} = Min	I _{OL} = 300 μA
			0.3	0.5		V _{IN} = V _{IH} or V _{IL}	I _{OL} = 48 mA (Mil)
			0.3	0.5			I _{OL} = 48 mA (Com)

377

DC Characteristics for 'FCT Family Devices (Continued)

Typical values are at $V_{CC} = 5.0V$, $25^{\circ}C$ ambient and maximum loading. For test conditions shown as Max, use the value specified for the appropriate device type: Com: $V_{CC} = 5.0V \pm 5\%$, $T_A = 0^{\circ}C$ to $+70^{\circ}C$; Mil: $V_{CC} = 5.0V \pm 10\%$, $T_A = -55^{\circ}C$ to $+125^{\circ}C$, $V_{HC} = V_{CC} - 0.2V$.

Symbol	Parameter	74FCT			Units	Conditions	
		Min	Typ	Max			
I_{CC}	Maximum Quiescent Supply Current	1.0	40.0		μA	$V_{CC} = \text{Max}$ $V_{IN} \geq V_{HC}$, $V_{IN} \leq 0.2V$ $f_i = 0$	
ΔI_{CC}	Quiescent Supply Current; TTL Inputs HIGH	0.5	2.0		mA	$V_{CC} = \text{Max}$ $V_{IN} = 3.4V$ (Note 3)	
I_{CCD}	Dynamic Power Supply Current (Note 4)	0.25	0.30		mA/MHz	$V_{CC} = \text{Max}$ Outputs Open $\overline{CE} = \text{GND}$ One Input Toggling 50% Duty Cycle	
I_C	Total Power Supply Current (Note 6)	1.5	4.0		mA	$V_{CC} = \text{Max}$ Outputs Open $f_{CP} = 10 \text{ MHz}$ 50% Duty Cycle	
		1.8	6.0			$V_{IN} \geq V_{HC}$ $V_{IN} \leq 0.2V$	
		3.0	9.0			$V_{IN} = 3.4V$ $V_{IN} = \text{GND}$	
		5.0	16.8			$V_{IN} \geq V_{HC}$ $V_{IN} \leq 0.2V$	
						$V_{IN} = 3.4V$ $V_{IN} = \text{GND}$	
V_H	Input Hysteresis on Clock Only	200			mV		

Note 1: Maximum test duration not to exceed one second, not more than one output shorted at one time.

Note 2: This parameter guaranteed but not tested.

Note 3: Per TTL driven input ($V_{IN} = 3.4V$); all other inputs at V_{CC} or GND.

Note 4: This parameter is not directly testable, but is derived for use in Total Power Supply calculations.

Note 5: Values for these conditions are examples of the I_{CC} formula. These limits are guaranteed but not tested.

Note 6: $I_C = I_{\text{QUIESCENT}} + I_{\text{INPUTS}} + I_{\text{DYNAMIC}}$

$I_C = I_{CC} + \Delta I_{CC} D_H N_T + I_{CCD} (f_{CP}/2 + f_i N_i)$

I_{CC} = Quiescent Current

ΔI_{CC} = Power Supply Current for a TTL HIGH Input ($V_{IN} = 3.4V$)

D_H = Duty Cycle for TTL inputs HIGH

N_T = Number of Inputs at D_H

I_{CCD} = Dynamic Current Caused by an Input Transition Pair (HLH or LHL)

f_{CP} = Clock Frequency for Register Devices (Zero for Non-Register Devices)

f_i = Input Frequency

N_i = Number of Inputs at f_i

All currents are in milliamps and all frequencies are in megahertz.

Note 7: For 54FCT, $I_{CCD} = 0.4 \text{ mA/MHz}$.

Refer to applicable standard military drawing or NSC Table I for test conditions and I_C/I_{CC} limits.

AC Electrical Characteristics: See Section 2 for Waveforms

Symbol	Parameter	54FCT/74FCT	74FCT	54FCT		Units	Fig. No.	
		$T_A = 25^\circ\text{C}$ $V_{CC} = 5.0\text{V}$	$T_A, V_{CC} = \text{Com}$ $R_L = 500\Omega$ $C_L = 50\text{pF}$	$T_A, V_{CC} = \text{Mil}$ $R_L = 500\Omega$ $C_L = 50\text{pF}$				
		Typ	Min (Note) Max	Min	Max			
t_{PLH} t_{PHL}	Propagation Delay C_p to \bar{O}_n	7.0	2.0 13.0	2.0	11.0	ns	2-8	
t_{SU}	Set Up Time HIGH or LOW D_n to C_p	1.0	2.5	4.0		ns	2-10	
t_H	Hold Time HIGH or LOW D_n to C_p	1.0	2.0	2.0		ns	2-10	
t_{SU}	Set Up Time HIGH or LOW \bar{CE} to C_p	1.5	4.0	4.5		ns	2-10	
t_H	Hold Time HIGH or LOW \bar{CE} to C_p	0.0	1.5	2.0		ns	2-10	
t_W	Clock Pulse Width, LOW	4.0	7.0	5.0		ns	2-9	
f_{max}	Maximum Clock Frequency			95		MHz		

Note: Minimum limits are guaranteed but not tested on propagation delays.

Capacitance $T_A = +25^\circ\text{C}, f = 1.0\text{ MHz}$

Symbol	Parameter	Typ	Max	Units	Conditions
C_{IN}	Input Capacitance	6	10	pF	$V_{IN} = 0\text{V}$
C_{OUT}	Output Capacitance	8	12	pF	$V_{OUT} = 0\text{V}$

Note: This parameter is measured at characterization but not tested.

C_{OUT} for 74FCT only.