

User Manual

VR10 Radar

Date: June 2020

Doc Version: 1.0

English

Thank you for choosing our product. Please read the instructions carefully before operation. Follow these instructions to ensure that the product is functioning properly. The images shown in this manual are for illustrative purposes only.



For further details, please visit our Company's website
www.zkteco.com.

Copyright © 2020 ZKTECO CO., LTD. All rights reserved.

Without the prior written consent of ZKTECO CO., LTD, no portion of this manual can be copied or forwarded in any way or form. All parts of this manual belong to ZKTeco and its subsidiaries (hereinafter the "Company" or "ZKTeco").

Trademark

ZKTeco is a registered trademark of ZKTECO CO., LTD. Other trademarks involved in this manual are owned by their respective owners.

Disclaimer

This manual contains information on the operation and maintenance of the ZKTeco product. The copyright in all the documents, drawings, etc. in relation to the ZKTeco supplied product vests in and is the property of ZKTeco. The contents hereof should not be used or shared by the receiver with any third party without express written permission of ZKTeco.

The contents of this manual must be read as a whole before starting the operation and maintenance of the supplied product. If any of the content(s) of the manual seems unclear or incomplete, please contact ZKTeco before starting the operation and maintenance of the said product.

It is an essential pre-requisite for the satisfactory operation and maintenance that the operating and maintenance personnel are fully familiar with the design and that the said personnel have received thorough training in operating and maintaining the machine/unit/product. It is further essential for the safe operation of the machine/unit/product that personnel have read, understood and followed the safety instructions contained in the manual.

In case of any conflict between terms and conditions of this manual and the contract specifications, drawings, instruction sheets or any other contract-related documents, the contract conditions/documents shall prevail. The contract specific conditions/documents shall apply in priority.

ZKTeco offers no warranty, guarantee or representation regarding the completeness of any information contained in this manual or any of the amendments made thereto. ZKTeco does not extend the warranty of any kind, including, without limitation, any warranty of design, merchantability or fitness for a particular purpose.

ZKTeco does not assume responsibility for any errors or omissions in the information or documents which are referenced by or linked to this manual. The entire risk as to the results and performance obtained from using the information is assumed by the user.

ZKTeco in no event shall be liable to the user or any third party for any incidental, consequential, indirect, special, or exemplary damages, including, without limitation, loss of business, loss of profits, business interruption, loss of business information or any pecuniary loss, arising out of, in connection with, or relating to the use of the information contained in or referenced by this manual, even if ZKTeco has been advised of the possibility of such damages.

This manual and the information contained therein may include technical, other inaccuracies or typographical errors. ZKTeco periodically changes the information herein which will be incorporated into new additions/amendments to the manual. ZKTeco reserves the right to add, delete, amend or modify the information contained in the manual from time to time in the form of circulars, letters, notes, etc. for better operation and safety of the machine/unit/product. The said additions or amendments are meant for improvement /better operations of the machine/unit/product and such amendments shall not give any right to claim any compensation or damages under any circumstances.

ZKTeco shall in no way be responsible (i) in case the machine/unit/product malfunctions due to any non-compliance of the instructions contained in this manual (ii) in case of operation of the machine/unit/product beyond the rate limits (iii) in case of operation of the machine and product in conditions different from the prescribed conditions of the manual.

The product will be updated from time to time without prior notice. The latest operation procedures and relevant documents are available on <http://www.zkteco.com>

If there is any issue related to the product, please contact us.

ZKTeco Headquarters

Address ZKTeco Industrial Park, No. 26, 188 Industrial Road,
Tangxia Town, Dongguan, China.

Phone +86 769 - 82109991

Fax +86 755 - 89602394

For business related queries, please write to us at: sales@zkteco.com.

To know more about our global branches, visit www.zkteco.com.

About the Company

ZKTeco is one of the world's largest manufacturer of RFID and Biometric (Fingerprint, Facial, Finger-vein) readers. Product offerings include Access Control readers and panels, Near & Far-range Facial Recognition Cameras, Elevator/floor access controllers, Turnstiles, License Plate Recognition (LPR) gate controllers and Consumer products including battery-operated fingerprint and face-reader Door Locks. Our security solutions are multi-lingual and localized in over 18 different languages. At the ZKTeco state-of-the-art 700,000 square foot ISO9001-certified manufacturing facility, we control manufacturing, product design, component assembly, and logistics/shipping, all under one roof.

The founders of ZKTeco have been determined for independent research and development of biometric verification procedures and the productization of biometric verification SDK, which was initially widely applied in PC security and identity authentication fields. With the continuous enhancement of the development and plenty of market applications, the team has gradually constructed an identity authentication ecosystem and smart security ecosystem, which are based on biometric verification techniques. With years of experience in the industrialization of biometric verifications, ZKTeco was officially established in 2007 and now has been one of the globally leading enterprises in the biometric verification industry owning various patents and being selected as the National High-tech Enterprise for 6 consecutive years. Its products are protected by intellectual property rights.

About the Manual

This manual introduces the operations of **VR10 Radar** product.

All figures displayed are for illustration purposes only. Figures in this manual may not be exactly consistent with the actual products.

Document Conventions

Conventions used in this manual are listed below:

GUI Conventions

| For Software | |
|------------------|---|
| Convention | Description |
| Bold font | Used to identify software interface names e.g. OK, Confirm, Cancel |
| > | Multi-level menus are separated by these brackets. For example, File > Create > Folder. |
| For Device | |
| Convention | Description |
| <> | Button or key names for devices. For example, press <OK> |
| [] | Window names, menu items, data table, and field names are inside square brackets. For example, pop up the [New User] window |
| / | Multi-level menus are separated by forwarding slashes. For example, [File/Create/Folder]. |

Symbols





| Convention | Description |
|---|--|
|  | This implies about the notice or pays attention to, in the manual |
|  | The general information which helps in performing the operations faster |
|  | The information which is significant |
|  | Care taken to avoid danger or mistakes |
|  | The statement or event that warns of something or that serves as a cautionary example. |

Table of Contents

| | | |
|----------|--|-----------|
| 1 | SAFETY MEASURES..... | 7 |
| 2 | INTRODUCTION..... | 9 |
| 2.1 | WHAT'S IN THE BOX?..... | 9 |
| 2.2 | FEATURES..... | 10 |
| 2.3 | APPEARANCE AND DIMENSIONS..... | 11 |
| 2.4 | TECHNICAL PARAMETERS..... | 12 |
| 3 | INSTALLATION..... | 13 |
| 3.1 | INSTALLATION INSTRUCTION..... | 13 |
| 3.2 | PRODUCT INSTALLATION..... | 14 |
| 3.3 | WIRING DETAILS..... | 15 |
| 4 | DEBUG RADAR WITH SOFTWARE..... | 18 |
| 5 | USE THE DIAL SWITCH TO DEBUG THE RADAR..... | 20 |
| 6 | FAQ..... | 22 |

1 Safety Measures

The following precautions are to keep the user's safety and prevent any damage. Please read carefully before installation.

1. **Read, follow, and retain instructions** - All safety and operational instructions must be properly read and followed before bringing the device into service.
2. **Do not ignore warnings** - Adhere to all warnings on the unit and in the operating instructions.
3. **Accessories** - Use only manufacturer-recommended or product-sold accessories. Accessories not recommended by the manufacturer must not be used.
4. **Precautions for the installation** - Do not place this device on an unstable stand or frame. It may fall and cause serious injury to persons and damage to the device.
5. **Service** - Do not try to service this unit yourself. Opening or removing covers may expose you to hazardous voltages or other hazards.
6. **Damage requiring service** - Disconnect the system from the main AC or DC power source and refer service personnel under the following conditions:
 - When cord or connection control is affected.
 - When the liquid was spilled, or an item dropped into the system.
 - If exposed to water and/or inclement weather (rain, snow, and more).
 - If the system is not operating normally under operating instructions.

Just change controls defined in operating instructions. Improper adjustment of other controls may result in damage and involve a qualified technician to return the device to normal operation.

7. **Replacement parts** - When replacement parts are needed, service technicians must only use replacement parts provided by the supplier. Unauthorized substitutes can result in a burn, shock, or other hazards.
8. **Safety check** - On completion of service or repair work on the unit, ask the service technician to perform safety checks to ensure proper operation of the unit.
9. **Power sources** - Operate the system only from the label's power source form. If the sort of power supply to use is unclear, call your dealer.
10. **Lightning** - External lightning conductors can be installed to protect against electrical storms. It stops power-ups destroying the system.

The devices should be installed in areas with limited access.

Electrical Safety

- Before connecting an external cable to the device, complete grounding properly and set up surge protection; otherwise, static electricity will damage the mainboard.
- Ensure that the signal connected to the device is a weak-current (switch) signal; otherwise, components of the device will be damaged.
- Ensure that the standard voltage applicable in your country or region is used. If you are not certain about the applicable standard voltage, please consult your local electric power company. A power mismatch may cause a short circuit or device damage.
- In the case of power supply damage, return the device to the professional technical personnel or your dealer for handling.
- To avoid interference, keep the device far from generators with strong electromagnetic radiation, such as radios, televisions, and electric generators

Operation Safety

- Before powering on the device, read this document carefully.
- Transportation and other unpredictable causes may damage the device hardware. Check whether the device has serious damage before installation. If the device has major defects you cannot solve, contact your dealer as soon as possible.
- Do not connect or disconnect cables to/from the device when it is energized.
- Dust, moisture, and abrupt temperature changes can affect the device's service life. You are advised not to keep the device under such conditions.
- Do not keep the device in a place that vibrates. Handle the device with care. Do not place heavy objects on top of the device.
- Do not apply rosin, alcohol, benzene, pesticides, and other volatile substances that can damage the device enclosure. Clean the enclosure with a piece of soft cloth or a small amount of cleaning agent.
- Nonprofessional personnel are not allowed to open the device cover. If you have any technical questions regarding usage, contact certified or experienced technical personnel.

Note

- Complete the grounding properly when connecting the power supply. The positive polarity and negative polarity of the DC 12V power supply must be connected correctly. A reverse connection may damage the device. Do not connect the AC 24V power supply to the DC 12V input port.
- Read the user manual carefully before use and connect wires in accordance with the positive polarity and negative polarity shown on the device's nameplate.

The warranty service does not cover accidental damage and damage caused by misoperation.

2 Introduction

VR10 Radar adopts highly integrated radio frequency chip, which has the characteristics of small size, low cost, works all the day in all-weather condition, high detection sensitivity, high accuracy, simple authorization and installation, stability and reliability.

The operating frequency of this Radar is 79GHz, the range resolution can reach 4cm, and the ranging accuracy is better than 2cm; the signal processing and control unit adopts both DSP and ARM dual-core architecture. Through the joint optimization design of software and hardware, this product can accurately identify and distinguish between pedestrians and vehicles passing through the barrier area, and prevent the barrier from hitting people and vehicles.

2.1 What's in the Box?

The box contains the following essentials.

| S. No | Accessories | Quantity |
|-------|------------------------|----------|
| 1 | VR10 Radar | 1 |
| 2 | M16 Nut | 1 |
| 3 | Gasket | 1 |
| 4 | Rubber waterproof ring | 1 |
| 5 | Wiring harness | 1 |
| 6 | User Manual | 1 |

2.2 Features

- Supports simultaneous detection of vehicles (bicycles, motorcycles, cars, trucks) and pedestrians.
- The detection range is adjustable within 1-6m (default 3m).
- Simple installation and debugging, saving material and labor costs.
- The Radar work is not affected by the external environment such as light, dust, rain, and snow.
- Supports 485 communication, could upgrade and debug online and could be debugged by DIP switch.
- Supports Straight Boom by default. And also supports Folding Boom, Fence Boom, and Advertising Boom (It is essential to learn how to record the environment).

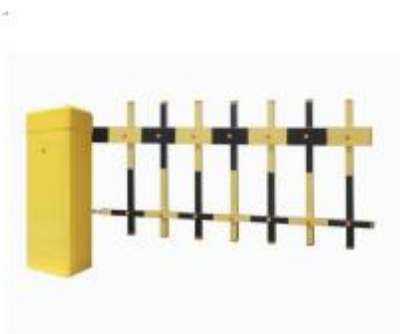

2.3 Appearance and Dimensions

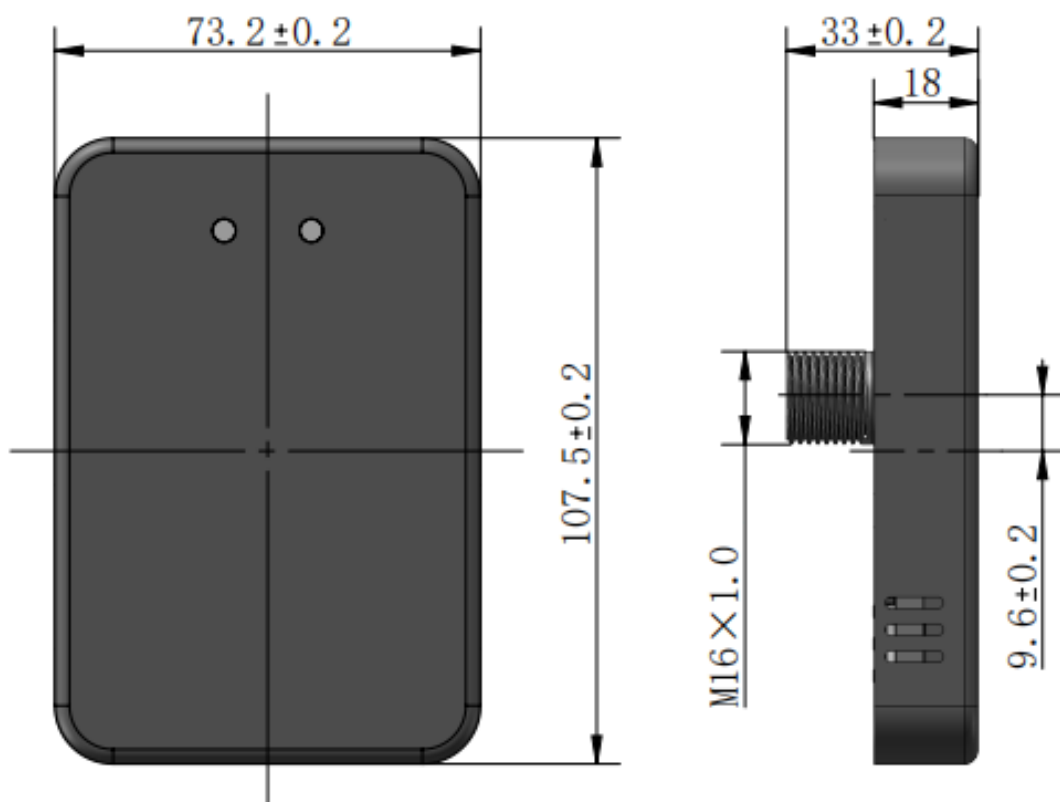
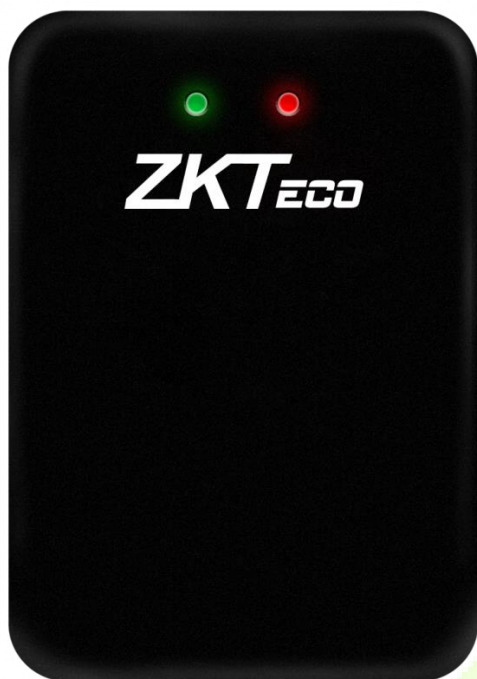

2.4 Technical Parameters

| Model | VR10 |
|-------------------------|-------------------|
| Detection Distance | 1-6m (default 3m) |
| Working Voltage(V) | 10-16V |
| Working Current | 0.2A |
| Working Temperature(°C) | -40°C~85°C |
| Power Consumption(W) | < 2.5 |
| Antenna Transmit Power | 12.5dBm |
| Antenna Gain | 10dBi |
| Waterproof Rating | IP67 |
| Communication Interface | RS485,relay |
| Shell Size (mm) | 107.5*73.2*18 |
| Packing Size (mm) | 166*94*97 |
| Net Weight | 228.4g |
| Gross Weight | 314.6g |

3 Installation

3.1 Installation Instruction

- The default detection distance is 3m, and the default supported boom type is the Straight Boom. If this need to be changed, it can be modified via software or DIP switch.
- Cannot be applied to other sliding doors and telescopic doors.



- After changing the detection environment (such as installation of road deflector, cone barrier in the detection area), it is essential to revise and set to record the environment again.
- Under normal circumstances, please set the detection distance according to the length of the boom. The detection distance could be set slightly less than or equal to the length of the boom to prevent people or objects outside the barrier boom from being detected by the Radar.
- If there is a mis-recognition in the detection because of the Radar that causes the door to open and does not close, then it is essential to revise and set the background again.
- The Radar is incorporated with the antenna inside and the surface of the Radar should be cleaned in time if covered with foreign objects (such as water drops, rain, snow, dust, etc.).
- The detection area of the Radar must be clean, and there must be no objects affecting the target detection (such as metal fences, billboards, license plate recognition cameras, walls, etc.) which by mistake prevents the Radar from being triggered.
- It is not recommended to use the Radar in the Fence and Advertisement boom type for a single mixed-in and mixed-out scenario.
- Dual-Radar installation is recommended for semi-trailer, cement tanker, and crane.
- When learning to record the environment, the Fence / Advertisement boom may wobble after it falls to the ground. So, it is always recommended to wait for the boom to fully stabilize before performing any subsequent operations.

3.2 Product Installation

1) Confirm the Radar Mounting Holes

The installation hole of the Radar is between 200-300mm from the inside of the straight boom and 650-800mm from the driveway ground (non-cement pier); and the installation position is shown in the below.

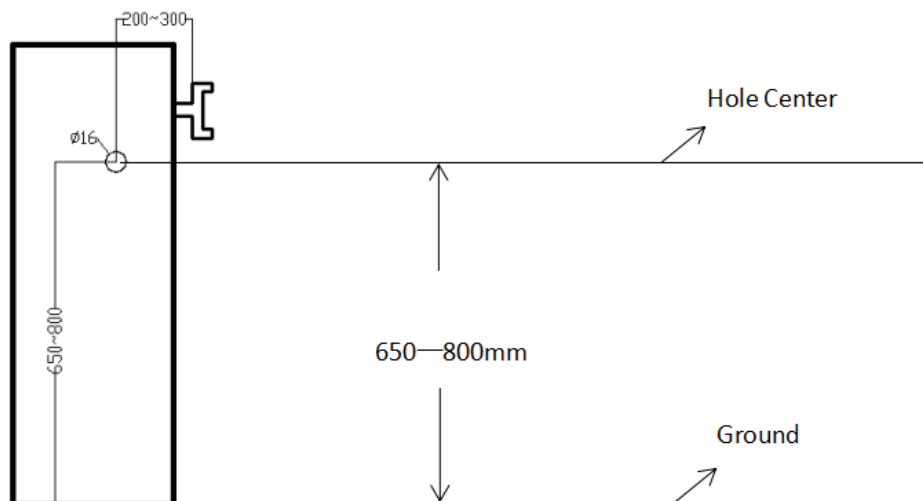

2) Drilling

Use an electric-drill to drill a fixed hole suitable for M16 at the selected position of the barrier box. The recommended drill bit diameter is 16mm.

3) Fix the Radar



(a) View of the Radar through the box



(b) The wiring connection passes through the gasket and nut



(c) Fix the Radar inside the cabinet



(d) Front display after installation

- As shown in the figure from (a)-(d), the Radar is fixed to the barrier box through the bottom bolt.
- First plug the Radar into the barrier box, and then cover the gasket with M16 screws to fix it.
- Then insert the end of the wire harness into the Radar in the correct direction and lock the metal buckle to complete the installation.

3.3 Wiring Details

1) Interface Cable Description

| Cable Identification | Cable Color | Description | Wiring |
|----------------------------|-------------|-------------|---|
| 12V | Red | power | The red wire connected to the 12V power positive output terminal; The black wire "GND" is connected to the negative output terminal of the 12V power supply. |
| GND | Black*2 | GND | |
| TX | Gray | A+ | The gray wire "A +" is connected to T / R + terminal of 485; The white wire "B-" is connected to the T / R- terminal of 485. |
| RX | White | B- | |
| Normally Open Signal Wire | Blue | NO1 | The green and blue wires are normally open signals of the relay, connecting the ground sense coil terminals and the common terminals of the barrier control main board (no distinction between positive and negative). |
| | Green | NO1 | |
| Normally Close Signal Wire | Brown | NC2 | The brown and purple wires are normally close signals of the relay, connecting the ground sense coil terminals and the common terminals of the barrier control main board (no distinction between positive and negative). |
| | Purple | NC2 | |

| | | | |
|------------|--------|-------|--|
| Dip Switch | Orange | Input | The orange wire is connected to the yellow wire through the DIP terminal (the DIP terminal is divided into ON terminal and 1 terminal) |
| | Yellow | GND | |

2) When connected to the barrier gate

When the Radar is connected to the P10, PB4000, CMP200 barrier gate, the normally open signal wire of the Radar, that is, the blue and green wires, are connected to the ground sense coil terminals and to the common terminals of the barrier control main board (no distinction between positive and negative).

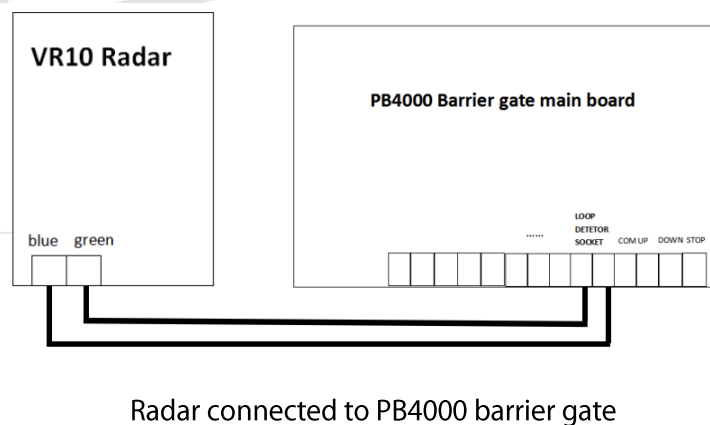
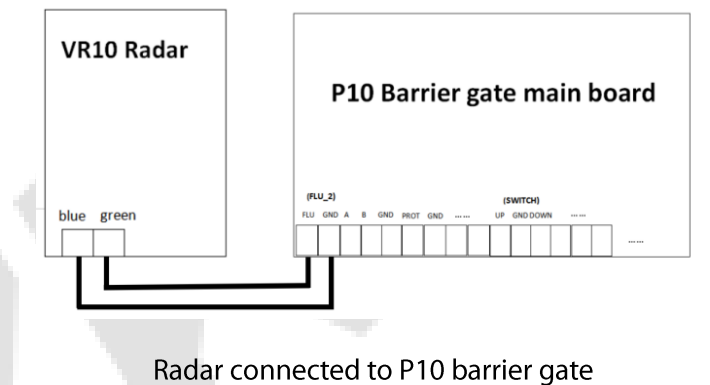

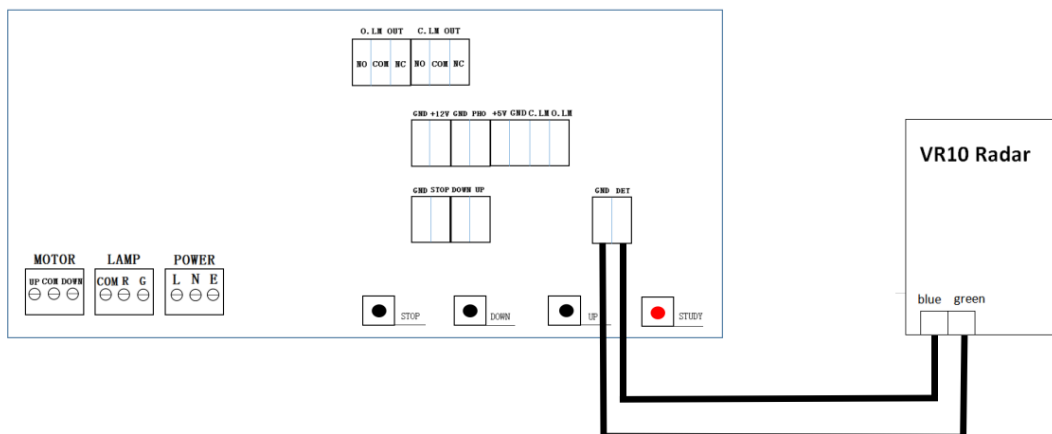

Radar connected to CMP200 barrier gate

Note: ProBG (wiring)

When the Radar is connected to the ProBG series barrier gate, the normally close signal lines of the Radar, that is, the brown and purple wires, are connected to the ground sense coil terminals and to the common terminals of the barrier control main board (no distinction between positive and negative).

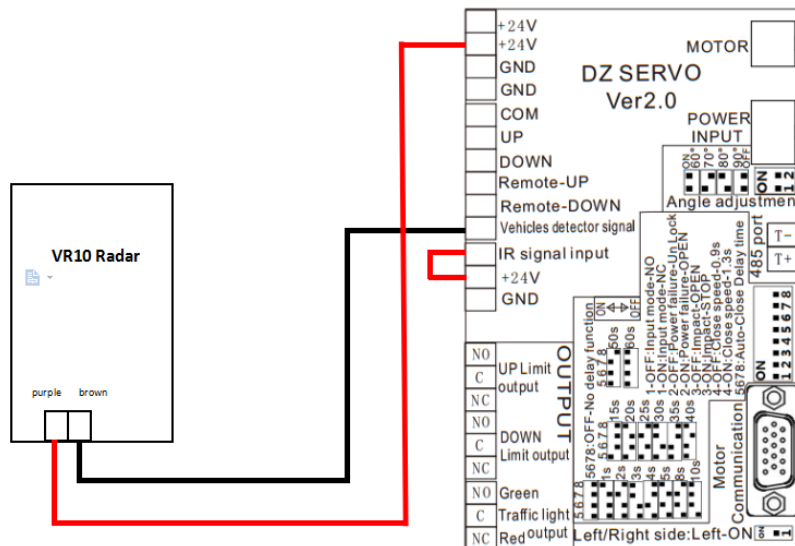

Radar connected to ProBG series barrier gate

4 Debug Radar with Software

1) Select the Port Number

Insert the 485 modules on the host computer to establish a connection with the Radar module. Find the port number in the computer's device manager list and select it.

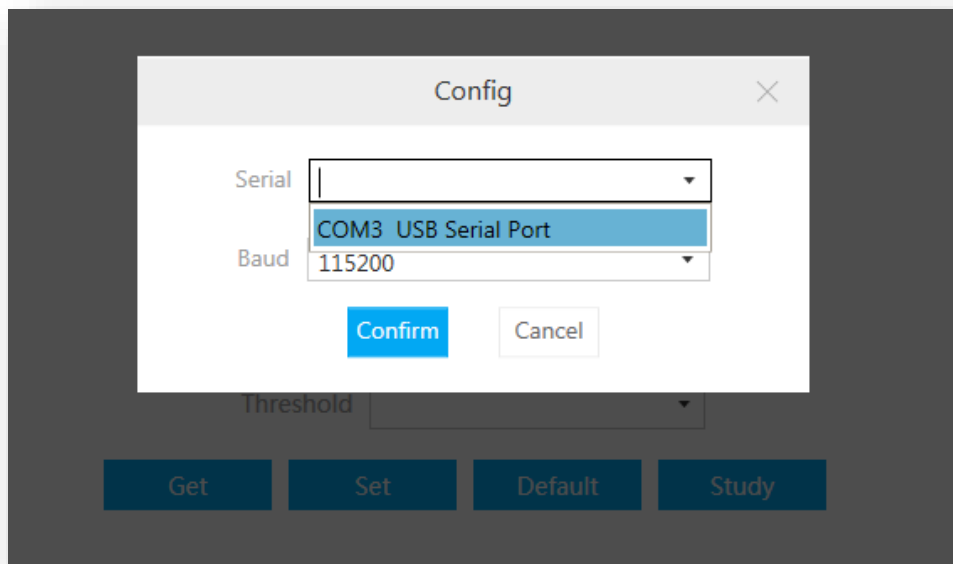

2) On the **Config** interface, set the detection area, boom type, and sensitivity (the high sensibility by default)

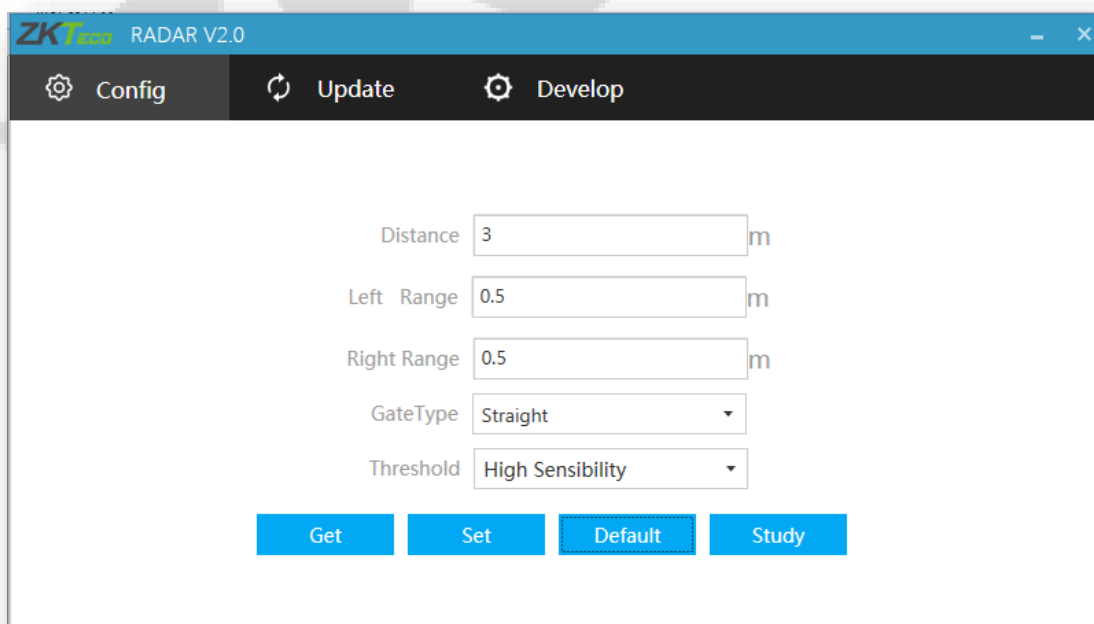

As shown in the figure above:

- **Distance:** Set the Radar monitoring distance.
- **Left Range, Right Range:** Set the Radar monitoring left range and right range.
- **Gate Type:** Set the boom type of the barrier.
- **Threshold:** Set the detection sensitivity.

High sensitivity supports anti-smashing and dropping boom (for people and vehicles when they leave the Radar detection area) for people and vehicles.

Medium sensitivity supports anti-smashing and dropping boom for vehicles, supports anti-smashing for people.

Low sensitivity supports anti-smashing and dropping boom for vehicles.

- **Get:** Gets current Radar parameters.
- **Set:** Saves the Radar parameters to make the settings effective.
- **Default:** The Radar parameters will be restored to the factory settings.
- The default sensibility is high sensibility, the default detection distance is 3m, and the left and right are 0.5m, the detection area is as shown in the figure below.

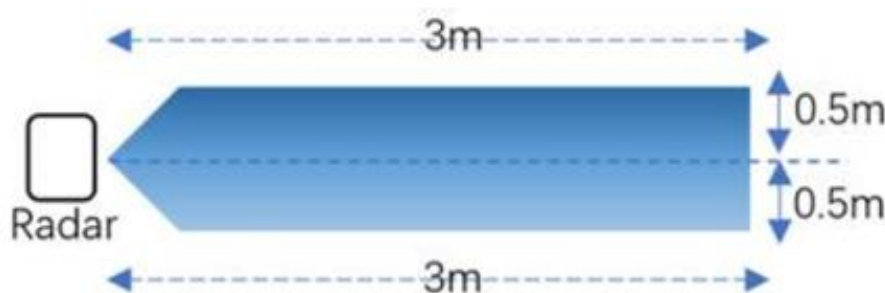

3) Background learning

Boom Type: Straight Boom.

The background learning steps are as follows:

- Keep the barrier boom in a raised state;
- Power on the Radar and click **Study** on the software;
- The straight boom will remain motionless and the light remains unchanged;
- The Radar can be restarted after power failure.

Boom Type: Fence Boom / Advertisement Boom / Airborne Gate.

The background learning steps are as follows:

- Keep the barrier boom in a raised state;
- Power on the Radar and click **Study** on the software;
- The barrier boom will fall automatically. Stand behind the Radar next to the barrier and observe the Radar green indicator light (or stand outside the long distance of the boom set opposite the Radar), the Radar green light will flash quickly;
- Wait for 3S after the boom is completely stabilized, use the barrier remote control to raise and lower it repeatedly for about three minutes until the green light is always on, indicating that the environmental record is complete;
- The Radar can be used after power off and restart.

Note: During background learning, ensure that there are no movable targets (vehicles, people) other than the fixed environment within the Radar detection range.

5 Use the Dial Switch to Debug the Radar

Boom Type: Straight Boom.

The debugging steps are as follows:

1. Distance setting

- Raise the barrier boom, and set the standing distance of the person, that is a position directly in front of the Radar.
- Turn on the DIP switch, and then supply power to the Radar.
- The green light of the Radar will flash quickly that is the green light of the Radar will turn on indicating that the distance has been set.
- Power off the Radar and set the DIP switch to 1.

2. Background learning

- Keep the barrier boom in the raised state.
- Power on the Radar, turn the DIP switch to the ON end once the power is on, wait for 6S and then turn the DIP switch back to the 1 end.
- The straight boom will remain stationary and the light will not change.
- Then the Radar can be powered off and restarted.

Note: During background learning, ensure that there are no movable targets (vehicles, people) other than the fixed environment within the Radar detection range.

Boom Type: Fence Boom / Advertisement Boom / Airborne Gate.

The debugging steps are as follows:

1. Distance setting

- Raise the barrier boom, and set the standing distance of the person.
- First turn the DIP switch to the ON end, and then supply power to the Radar.
- When the Radar flashes green quickly, turn the DIP switch to the 1 end, Radar green light will be always on indicating that the distance has been set.
- The Radar can be powered off.

2. Background learning

- Keep the barrier boom in the raised state.
- Turn on the power of the Radar, and turn the DIP switch to the ON end once the power is on.
- The barrier boom will fall automatically. Set the DIP switch back to the 1 end, and stand behind the Radar next to the barrier to observe the Radar's green indicator light (or stand outside the long distance of the boom set opposite to the Radar), the Radar green light will flash quickly.
- Wait for 3S after the boom is completely stabilized, use the barrier remote control to raise and lower the boom repeatedly for about three minutes until the green light is always on, indicating that the environmental record is complete.
- The Radar can be used after power off and restart.

Note: During background learning, ensure that there are no movable targets (vehicles, people) other than the fixed environment within the Radar detection range.

6 FAQ

1. **Problem:** After installation, the green light of the Radar is always on, and the boom does not fall.

Possible Cause: The newly added strong reflector in the Radar detection range needs to be moved out of the Radar field of view or re-learned for background learning.

2. **Problem:** If the person is standing in front of the Radar the green light will not turn on.

Possible Cause: The Radar starts to detect the difference between people and vehicles after the car triggers the Radar light.

3. **Problem:** The red light of Radar flashes when the 12V power supplied by the gate control board is on.

Possible Cause: It is recommended to connect an external 12V-1A power adapter.

ZKTeco Industrial Park, No. 26, 188 Industrial Road,

Tangxia Town, Dongguan, China.

Phone : +86 769 - 82109991

Fax : +86 755 - 89602394

www.zkteco.com

