

EL5224, EL5324, EL5424

12MHz Rail-to-Rail Buffers + 100mA V_{COM} Amplifier

FN7004
Rev.4.00
Aug 28, 2017

The [EL5224](#), [EL5324](#), and [EL5424](#) feature 8, 10, and 12 low power buffers, respectively, and one high power output amplifier. They are designed primarily for buffering column driver reference voltages in TFT-LCD applications as well as generation of the V_{COM} supply. Each low power buffer features a -3dB bandwidth of 12MHz and features rail-to-rail input/output capability. The high power buffer can drive 100mA and swings to within 2V of each rail.

The 8-channel EL5224 is available in 24 Ld QFN and 24 Ld HTSSOP packages, the 10-channel EL5324 is available in 32 Ld QFN and 28 Ld HTSSOP packages, and the 12-channel EL5424 is available in the 32 Ld QFN package. They are specified for operation across the full -40°C to +85°C temperature range.

Related Literature

- For a full list of related documents, visit our website
 - [EL5224](#), [EL5324](#), [EL5424](#) product pages

Features

- 8, 10, and 12 channel versions
- 12MHz -3dB buffer bandwidth
- 150mA V_{COM} buffer
- Operating supply voltage from 4.5V to 16.5V
- Low supply current - 6mA total (8-channel version)
- Rail-to-rail input/output swing (buffers only)
- QFN package - just 0.9mm high
- Pb-free (RoHS compliant)

Applications

- TFT-LCD column driver buffering and V_{COM} supply
- Electronics notebooks
- Computer monitors
- Electronics games
- Touch-screen displays
- Portable instrumentation

Ordering Information

PART NUMBER (Notes 1, 2)	PACKAGE (RoHS COMPLIANT)	TAPE & REEL SIZE/QTY	PKG. DWG. #
EL5224ILZ (No longer available or supported)	24 Ld QFN	-	MDP0046
EL5224ILZ-T7 (No longer available or supported)	24 Ld QFN	7"/1k	MDP0046
EL5224ILZ-T13 (No longer available or supported)	24 Ld QFN	13"/2.5k	MDP0046
EL5224IREZ (No longer available or supported)	24 Ld HTSSOP	-	MDP0048
EL5224IREZ-T7 (No longer available or supported)	24 Ld HTSSOP	7"/1k	MDP0048
EL5224IREZ-T13 (No longer available or supported)	24 Ld HTSSOP	13"/2.5k	MDP0048
EL5324ILZ (No longer available or supported)	32 Ld QFN	-	L32.5x6B
EL5324ILZ-T7 (No longer available or supported)	32 Ld QFN	7"/1k	L32.5x6B
EL5324ILZ-T13 (No longer available or supported)	32 Ld QFN	13"/2.5k	L32.5x6B
EL5324IREZ	28 Ld HTSSOP	-	MDP0048
EL5324IREZ-T7	28 Ld HTSSOP	7"/1k	MDP0048
EL5324IREZ-T13	28 Ld HTSSOP	13"/2.5k	MDP0048
EL5424ILZ (No longer available or supported)	32 Ld QFN	-	L32.5x6B
EL5424ILZ-T7 (No longer available or supported)	32 Ld QFN	7"/1k	L32.5x6B
EL5424ILZ-T13 (No longer available or supported)	32 Ld QFN	13"/2.5k	L32.5x6B

NOTES:

- Intersil Pb-free products employ special Pb-free material sets; molding compounds/die attach materials and 100% matte tin plate termination finish, which are RoHS compliant and compatible with both SnPb and Pb-free soldering operations. Intersil Pb-free products are MSL classified at Pb-free peak reflow temperatures that meet or exceed the Pb-free requirements of IPC/JEDEC J STD-020.
- For Moisture Sensitivity Level (MSL), see product information pages for [EL5224](#), [EL5324](#), [EL5424](#). For more information on MSL, refer to [TB363](#).

Pin Configurations

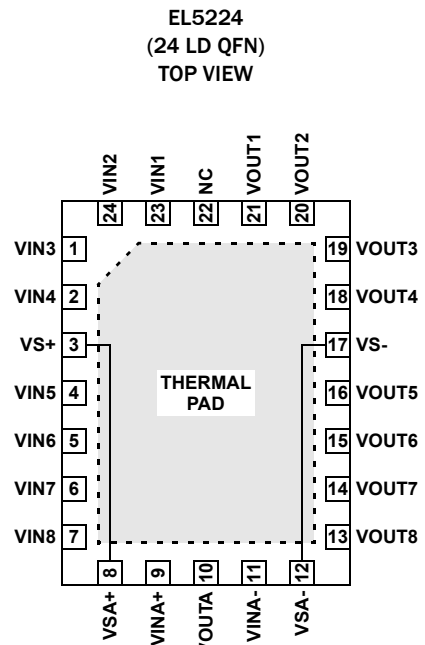
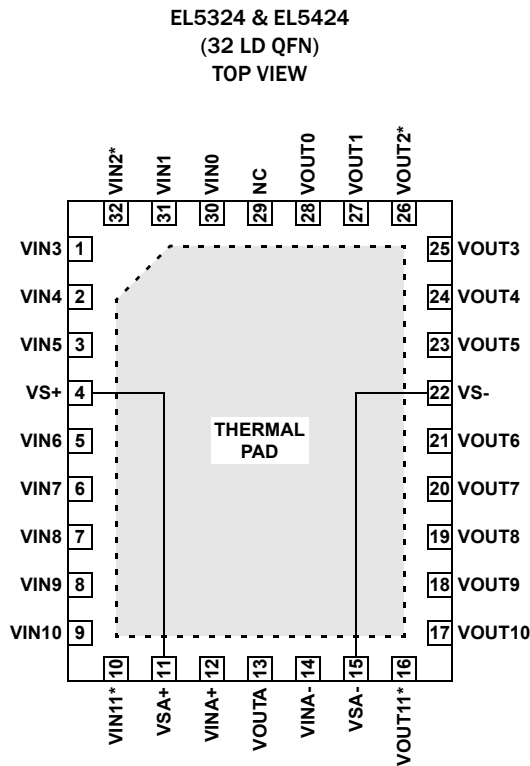
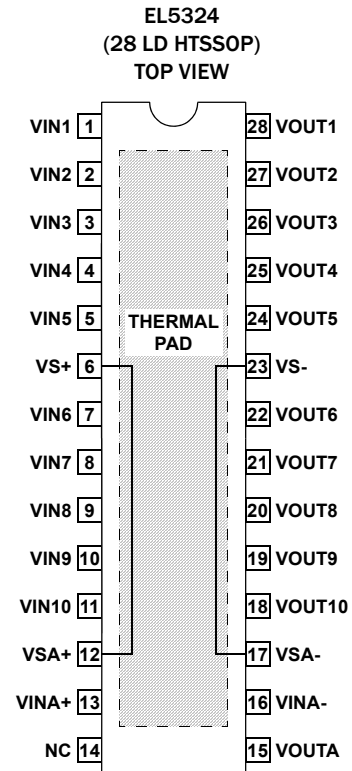
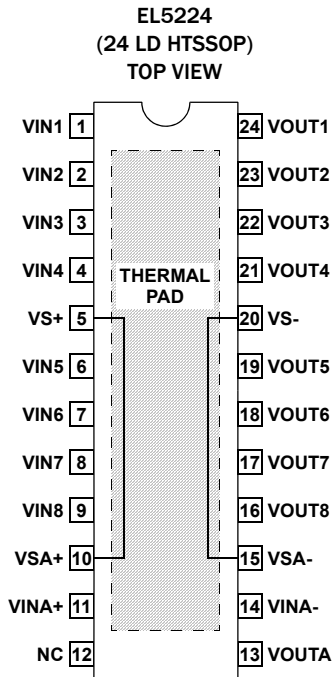

*Not available in EL5324

Pin Descriptions

24 Ld HTSSOP	24 Ld QFN	32 Ld QFN	28 Ld HTSSOP	PIN NAME	PIN FUNCTION
1	23	31	1	VIN1	Input
2	24	32 (Note 3)	2	VIN2	Input
3	1	1	3	VIN3	Input
4	2	2	4	VIN4	Input
5	3	4	6	VS+	Power
6	4	3	5	VIN5	Input
7	5	5	7	VIN6	Input
8	6	6	8	VIN7	Input
9	7	7	9	VIN8	Input
10	8	11	12	VSA+	Power
11	9	12	13	VINA+	Positive input of V _{COM}
12	22	29	14	NC	Not connected
13	10	13	15	VOUTA	Output of V _{COM}
14	11	14	16	VINA-	Negative input of V _{COM}
15	12	15	17	VSA-	Power
16	13	19	20	VOUT8	Output
17	14	20	21	VOUT7	Output
18	15	21	22	VOUT6	Output
19	16	23	24	VOUT5	Output
20	17	22	23	VS-	Power
21	18	24	25	VOUT4	Output
22	19	25	26	VOUT3	Output
23	20	26 (Note 3)	27	VOUT2	Output
24	21	27	28	VOUT1	Output
		8	10	VIN9	Input
		9	11	VIN10	Input
		10 (Note 3)		VIN11	Input
		16 (Note 3)		VOUT11	Output
		17	18	VOUT10	Output
		18	19	VOUT9	Output
		28		VOUT0	Output
		30		VINO	Input

NOTE:

3. Not available in EL5324IL

Absolute Maximum Ratings (T_A = +25 °C)

Supply Voltage between V _{S+} and V _{S-}	+18V	Power Dissipation.....	See Curves
Input Voltage.....	V _{S-} -0.5V, V _{S+} +0.5V	Maximum Die Temperature.....	+125 °C
Maximum Continuous Output Current (V _{OUTO-9}).....	30mA	Storage Temperature.....	-65 °C to +150 °C
Maximum Continuous Output Current (V _{OUTA}).....	150mA	Ambient Operating Temperature.....	-40 °C to +85 °C

CAUTION: Stresses above those listed in "Absolute Maximum Ratings" may cause permanent damage to the device. This is a stress only rating and operation of the device at these or any other conditions above those indicated in the operational sections of this specification is not implied.

NOTE: All parameters having Min/Max specifications are established. Typical values are for information purposes only. Unless otherwise noted, all tests are at the specified temperature and are pulsed tests, therefore: T_J = T_C = T_A

Electrical Specifications V_{S+} = +15V, V_{S-} = 0, R_L = 10kΩ, R_F = R_G = 20kΩ, C_L = 10pF to 0V, Gain of V_{COM} = -1, and T_A = +25 °C, unless otherwise specified

DESCRIPTION	PARAMETER	CONDITIONS	MIN	TYP	MAX	UNIT
INPUT CHARACTERISTICS (REFERENCE BUFFERS)						
Input Offset Voltage	V _{OS}	V _{CM} = 0V		2	14	mV
Average Offset Voltage Drift	TCV _{OS}	(Note 4)		5		μV/°C
Input Bias Current	I _B	V _{CM} = 0V		2	50	nA
Input Impedance	R _{IN}			1		GΩ
Input Capacitance	C _{IN}			1.35		pF
Voltage Gain	A _V	1V ≤ V _{OUT} ≤ 14V	0.992		1.008	V/V
INPUT CHARACTERISTICS (V_{COM} BUFFER)						
Input Offset Voltage	V _{OS}	V _{CM} = 7.5V		1	4	mV
Average Offset Voltage Drift	TCV _{OS}	(Note 4)		3		μV/°C
Input Bias Current	I _B	V _{CM} = 7.5V		2	100	nA
Input Impedance	R _{IN}			1		GΩ
Input Capacitance	C _{IN}			1.35		pF
Load Regulation	V _{REG}	V _{COM} = 6V, -100mA < I _L < 100mA	-20		+20	mV
OUTPUT CHARACTERISTICS (REFERENCE BUFFERS)						
Output Swing Low	V _{OL}	I _L = 7.5mA		50	150	mV
Output Swing High	V _{OH}	I _L = 7.5mA	14.85	14.95		V
Short-Circuit Current	I _{SC}		120	140		mA
OUTPUT CHARACTERISTICS (V_{COM} BUFFER)						
Output Swing Low	V _{OL}	50Ω to 7.5V		1	1.5	V
Output Swing High	V _{OH}	50Ω to 7.5V	13.5	14		V
Short-Circuit Current	I _{SC}			160		mA
POWER SUPPLY PERFORMANCE						
Power Supply Rejection Ratio	PSRR	Reference buffer V _S from 5V to 15V	55	80		dB
		V _{COM} buffer, V _S from 5V to 15V	60	100		dB
Total Supply Current	I _S	EL5224 (no load)	5	6.8	8	mA
		EL5324 (no load)	6	7.8	9.5	mA
		EL5424 (no load)	7	8.8	11	mA
DYNAMIC PERFORMANCE (BUFFER AMPLIFIERS)						
Slew Rate (Note 5)	SR	-4V ≤ V _{OUT} ≤ 4V, 20% to 80%	7	15		V/μs
Settling to +0.1% (A _V = +1)	t _S	(A _V = +1), V _O = 2V step		250		ns
-3dB Bandwidth	BW	R _L = 10kΩ, C _L = 10pF		12		MHz

Electrical Specifications $V_{S+} = +15V$, $V_{S-} = 0$, $R_L = 10k\Omega$, $R_F = R_G = 20k\Omega$, $C_L = 10pF$ to $0V$, Gain of $V_{COM} = -1$, and $T_A = +25^\circ C$, unless otherwise specified (Continued)

DESCRIPTION	PARAMETER	CONDITIONS	MIN	TYP	MAX	UNIT
Gain-Bandwidth Product	GBWP	$R_L = 10k\Omega$, $C_L = 10pF$		8		MHz
Phase Margin	PM	$R_L = 10k\Omega$, $C_L = 10pF$		50		°
Channel Separation	CS	$f = 5MHz$		75		dB

NOTES:

- 4. Measured across operating temperature range.
- 5. Slew rate is measured on rising and falling edges.

Typical Performance Curves

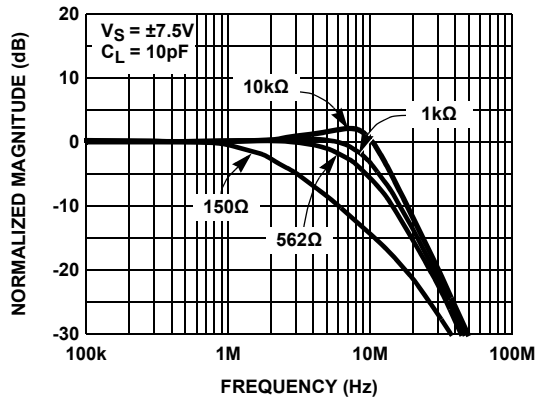

FIGURE 1. FREQUENCY RESPONSE FOR VARIOUS R_L (BUFFER)

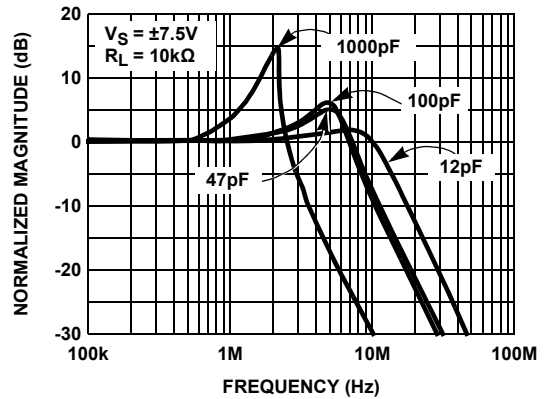

FIGURE 2. FREQUENCY RESPONSE FOR VARIOUS C_L (Buffer)

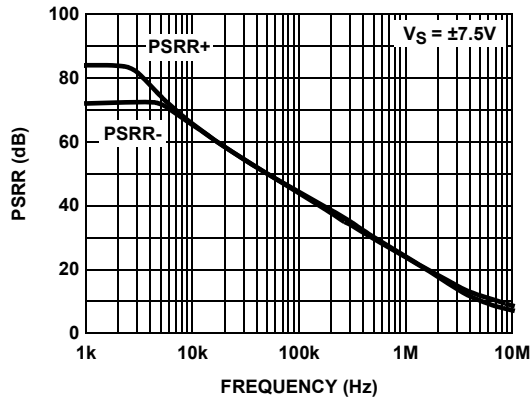

FIGURE 3. PSRR vs FREQUENCY (BUFFER)

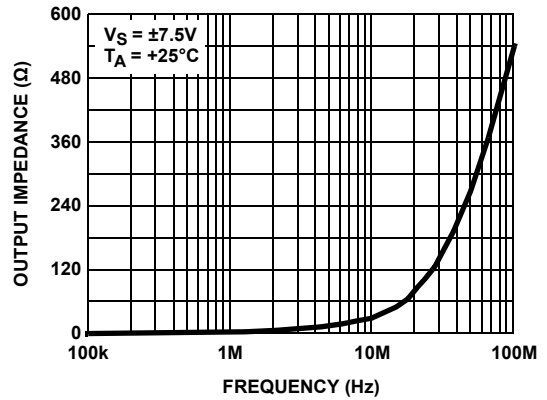

FIGURE 4. OUTPUT IMPEDANCE vs FREQUENCY (BUFFER)

Typical Performance Curves (Continued)

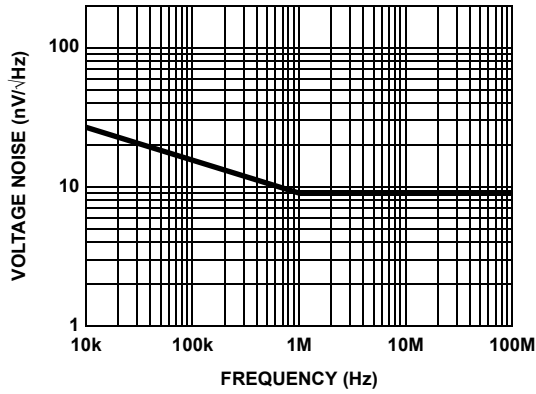

FIGURE 5. INPUT NOISE SPECIAL DENSITY vs FREQUENCY (BUFFER)

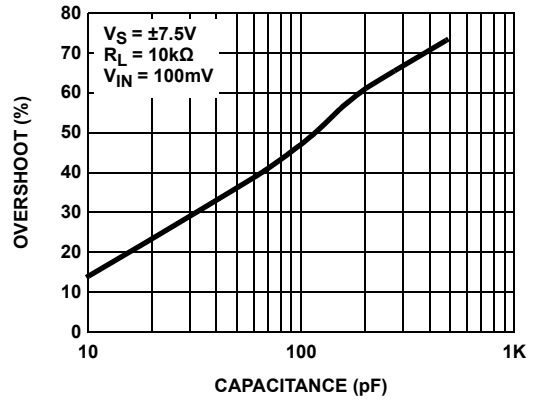

FIGURE 6. OVERSHOOT vs LOAD CAPACITANCE (BUFFER)

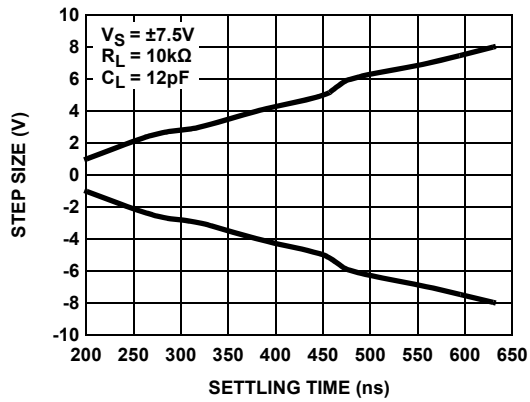

FIGURE 7. SETTLING TIME vs STEP SIZE (BUFFER)

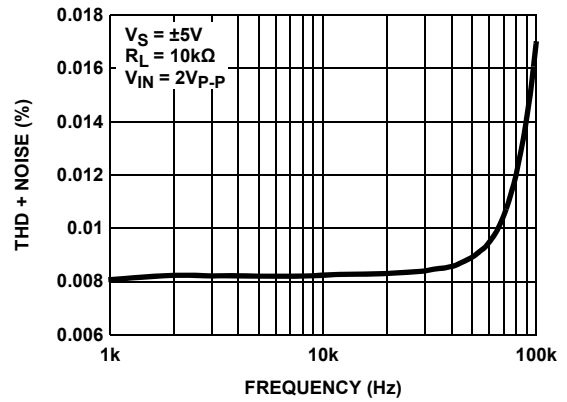

FIGURE 8. TOTAL HARMONIC DISTORTION + NOISE vs FREQUENCY (BUFFER)

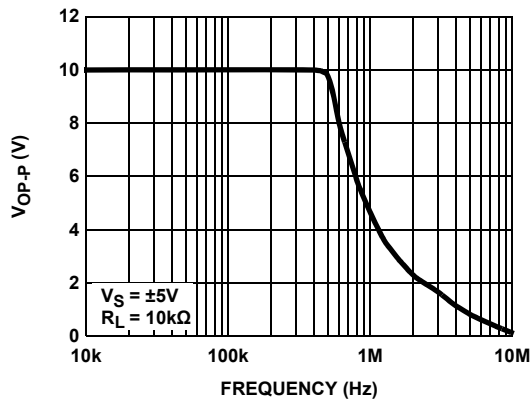

FIGURE 9. OUTPUT SWING vs FREQUENCY (BUFFER)

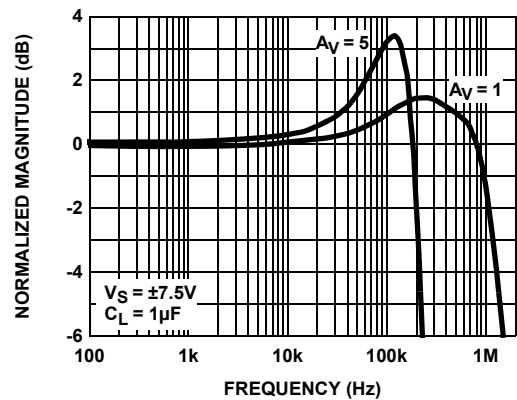

FIGURE 10. FREQUENCY RESPONSE (V_{COM})

Typical Performance Curves (Continued)

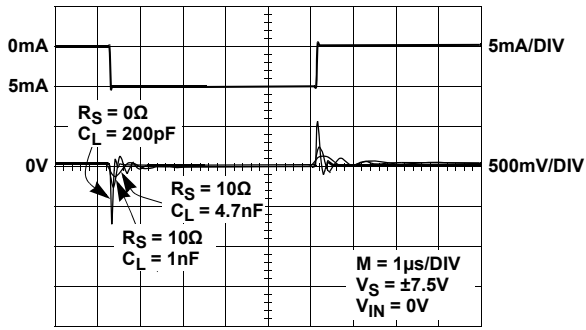

FIGURE 11. TRANSIENT LOAD REGULATION - SOURCING (BUFFER)

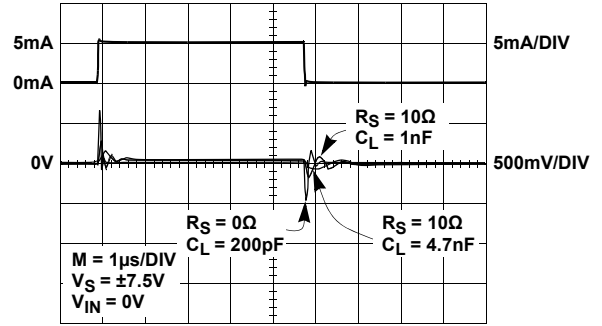

FIGURE 12. TRANSIENT LOAD REGULATION - SINKING (BUFFER)

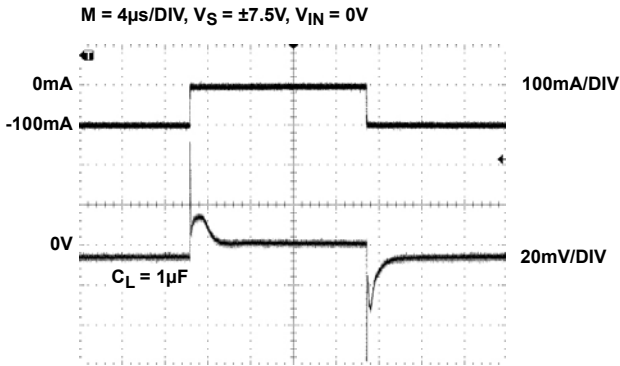

FIGURE 13. TRANSIENT LOAD REGULATION - SOURCING (V_{COM})

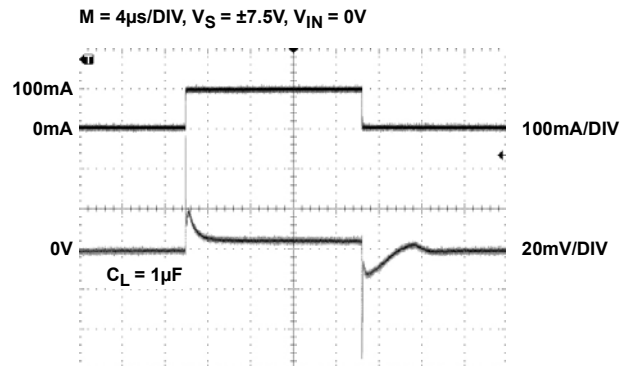

FIGURE 14. TRANSIENT LOAD REGULATION - SINKING (V_{COM})

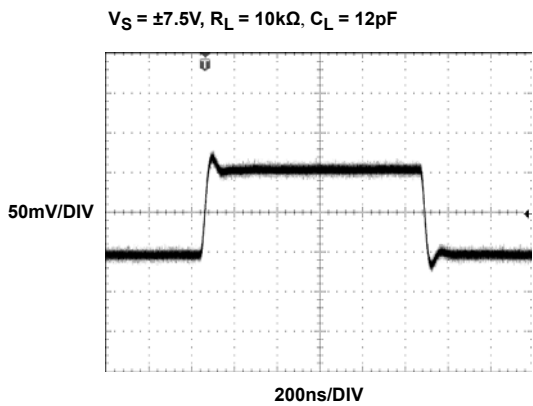

FIGURE 15. SMALL SIGNAL TRANSIENT RESPONSE (BUFFER)

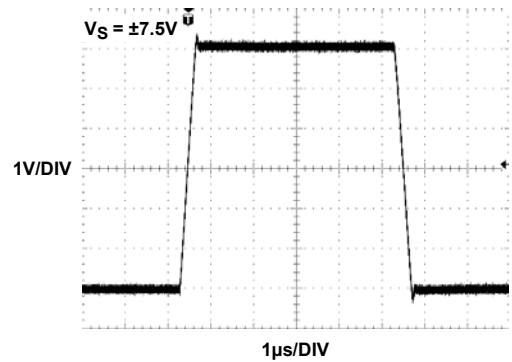

FIGURE 16. LARGE SIGNAL TRANSIENT RESPONSE (BUFFER)

Typical Performance Curves (Continued)

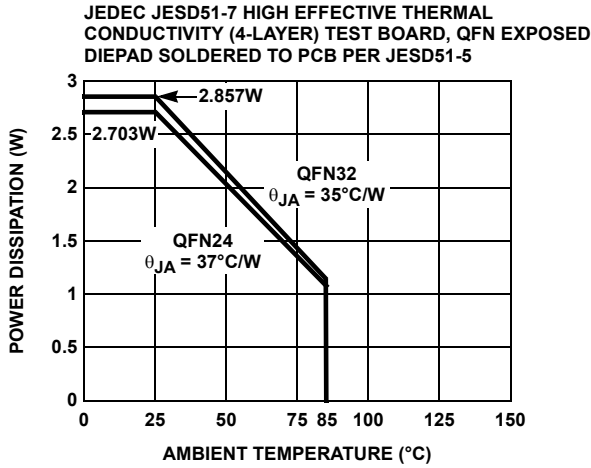

FIGURE 17. PACKAGE POWER DISSIPATION vs AMBIENT TEMPERATURE

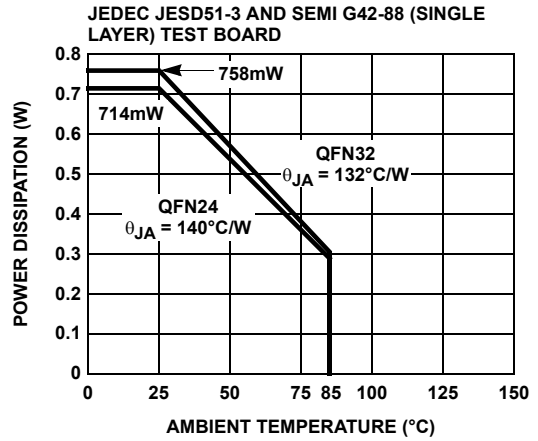

FIGURE 18. PACKAGE POWER DISSIPATION vs AMBIENT TEMPERATURE

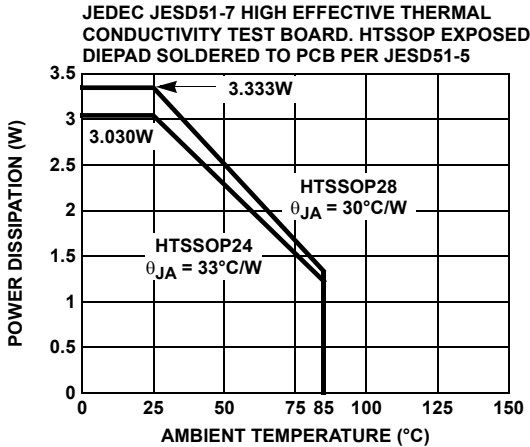

FIGURE 19. PACKAGE POWER DISSIPATION vs AMBIENT TEMPERATURE

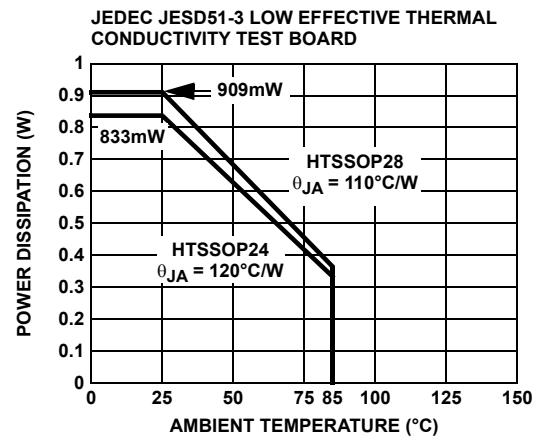

FIGURE 20. PACKAGE POWER DISSIPATION vs AMBIENT TEMPERATURE

Applications Information

Product Description

The EL5224, EL5324, and EL5424 unity gain buffers and 100mA V_{COM} amplifier are fabricated using a high voltage CMOS process. The buffers exhibit rail-to-rail input and output capability and has low power consumption (600 μ A per buffer). When driving a load of 10k Ω and 12pF, the buffers have a -3dB bandwidth of 12MHz and exhibits 18V/ μ s slew rate. The V_{COM} amplifier exhibits rail-to-rail input. The output can be driving to within 2V of each supply rail. With a 1 μ F capacitance load, the GBWP is about 1MHz.

Correct operation is ensured for a supply range of 4.5V to 16.5V.

The Use of the Buffers

The output swings of the buffers typically extend to within 100mV of positive and negative supply rails with load currents of 5mA. Decreasing load currents will extend the output voltage range even closer to the supply rails. [Figure 21](#) shows the input and output waveforms for the device. Operation is from $\pm 5V$ supply with a 10k Ω load connected to GND. The input is a 10V $_{P-P}$ sinusoid. The output voltage is approximately 9.985V $_{P-P}$.

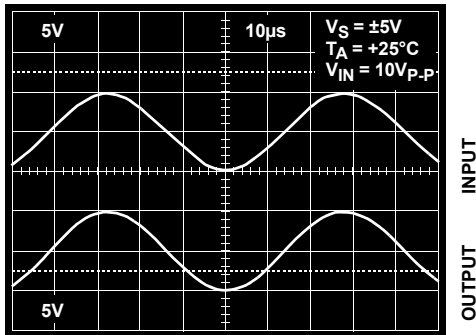

FIGURE 21. Operation with Rail-to-Rail Input and Output

SHORT-CIRCUIT CURRENT LIMIT

The buffers will limit the short-circuit current to $\pm 120mA$ if the output is directly shorted to the positive or the negative supply. If an output is shorted indefinitely, the power dissipation could easily increase such that the device may be damaged. Maximum reliability is maintained if the output continuous current never exceeds $\pm 30mA$. This limit is set by the design of the internal metal interconnects.

OUTPUT PHASE REVERSAL

The buffers are immune to phase reversal as long as the input voltage is limited from $V_S - 0.5V$ to $V_S + 0.5V$. [Figure 22](#) shows a photo of the output of the device with the input voltage driven beyond the supply rails. Although the device's output will not change phase, the input's overvoltage should be avoided. If an input voltage exceeds supply voltage by more than 0.6V, electrostatic protection diodes placed in the input stage of the device begin to conduct and overvoltage damage could occur.

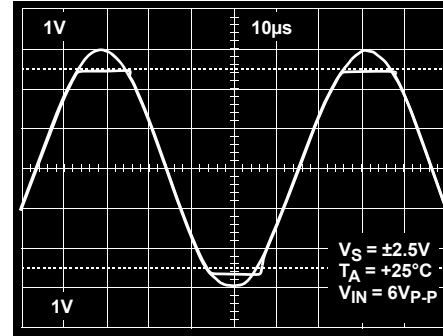

FIGURE 22. Operation with Beyond-the-Rails Input

UNUSED BUFFERS

It is recommended that any unused buffers have their inputs tied to the ground plane.

DRIVING CAPACITIVE LOADS

The buffers can drive a wide range of capacitive loads. As load capacitance increases, however, the -3dB bandwidth of the device will decrease and the peaking increase. The buffers drive 10pF loads in parallel with 10k Ω with just 1.5dB of peaking, and 100pF with 6.4dB of peaking. If less peaking is desired in these applications, a small series resistor (usually between 5 Ω and 50 Ω) can be placed in series with the output. However, this will obviously reduce the gain slightly. Another method of reducing peaking is to add a snubber circuit at the output. A snubber is a shunt load consisting of a resistor in series with a capacitor. Values of 150 Ω and 10nF are typical. The advantage of a snubber is that it does not draw any DC load current or reduce the gain.

The Use of V_{COM} Amplifier

The V_{COM} amplifier is designed to control the voltage on the back plate of an LCD display. This plate is capacitively coupled to the pixel drive voltage which alternately cycles positive and negative at the line rate for the display. Thus, the amplifier must be capable of sourcing and sinking capacitive pulses of current, which can occasionally be quite large (a few 100mA for typical applications).

A simple use of the V_{COM} amplifier is as a voltage follower, as illustrated in [Figure 23 on page 11](#). Here, a voltage, corresponding to the mid-DAC potential, is generated by a resistive divider and buffered by the amplifier. The amplifier's stability is designed to be dominated by the load capacitance, thus for very short duration pulses (<1 μ s) the output capacitor supplies the current. For longer pulses the V_{COM} amplifier supplies the current. By virtue of its high transconductance which progressively increases as more current is drawn, it can maintain regulation within 5mV as currents up to 100mA are drawn, while consuming only 2mA of quiescent current.

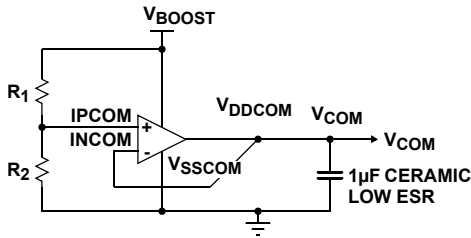

FIGURE 23. VCOM Used as a Voltage Buffer

Alternatively, the back plate potential can be generated by a DAC and the VCOM amplifier used to buffer the DAC voltage, with gain if necessary. This is shown in Figure 24. In this case, the effective transconductance of the feedback is reduced, thus the amplifier will be more stable, but regulation will be degraded by the feedback factor.

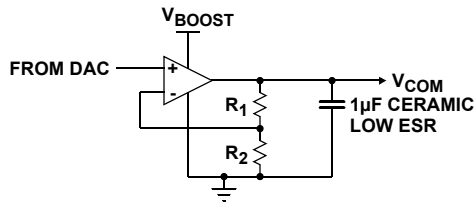

FIGURE 24. VCOM Used as a Buffer with Gain

CHOICE OF OUTPUT CAPACITOR

A 1µF ceramic capacitor with low ESR is recommended for this amplifier. (For example, GRM42_6X7R105K16.) This capacitor determines the stability of the amplifier. Reducing it will make the amplifier less stable, and should be avoided. With a 1µF capacitor, the unity gain bandwidth of the amplifier is close to 1MHz when reasonable currents are being drawn. (For lower load currents, the gain and hence bandwidth progressively decreases.) This means the active trans-conductance is:

$$2\pi \times 1\mu\text{F} \times 1\text{MHz} = 6.28\text{S}$$

This high transconductance indicates why it is important to have a low ESR capacitor.

If $\text{ESR} \times 6.28 > 1$, then the capacitor will not force the gain to roll off below unity, and subsequent poles can affect stability. The recommended capacitor has an ESR of 10mΩ, but to this must be added the resistance of the board trace between the capacitor and the sense connection - therefore this should be kept short, as illustrated in Figure 21, by the diagonal line to the capacitor. Also ground resistance between the capacitor and the base of R2 must be kept to a minimum. These constraints should be considered when laying out the PCB.

If the capacitor is increased above 1µF, stability is generally improved and short pulses of current will cause a smaller “perturbation” on the VCOM voltage. The speed of response of the amplifier is however degraded as its bandwidth is decreased. At capacitor values around 10µF, a subtle interaction with internal DC gain boost circuitry will decrease the phase margin and may give rise to some overshoot in the response. The amplifier will remain stable though.

RESPONSE TO HIGH CURRENT SPIKES

The VCOM amplifier’s output current is limited to 150mA. This limit level, which is roughly the same for sourcing and sinking, is included to maintain reliable operation of the part. It does not necessarily prevent a large temperature rise if the current is maintained. (In this case the whole chip may be shut down by the thermal trip to protect functionality.) If the display occasionally demands current pulses higher than this limit, the reservoir capacitor will provide the excess and the amplifier will top the reservoir capacitor back up once the pulse has stopped. This will happen on the µs time scale in practical systems and for pulses 2 or 3 times the current limit, the VCOM voltage will have settled again before the next line is processed.

Power Dissipation

With the high-output drive capability of the EL5224, EL5324, and EL5424 buffer, it is possible to exceed the +125°C “absolute-maximum junction temperature” under certain load current conditions. Therefore, it is important to calculate the maximum junction temperature for the application to determine if load conditions need to be modified for the buffer to remain in the safe operating area.

The maximum power dissipation allowed in a package is determined according to:

$$P_{\text{DMAX}} = \frac{T_{\text{JMAX}} - T_{\text{AMAX}}}{\theta_{\text{JA}}}$$

where:

- T_{JMAX} = Maximum junction temperature
- T_{AMAX} = Maximum ambient temperature
- θ_{JA} = Thermal resistance of the package
- P_{DMAX} = Maximum power dissipation in the package

The maximum power dissipation actually produced by an IC is the total quiescent supply current times the total power supply voltage, plus the power in the IC due to the loads, or:

$$P_{\text{DMAX}} = \Sigma i \times [V_{\text{S}} \times I_{\text{SMAX}} + (V_{\text{S}+} - V_{\text{OUT}i}) \times I_{\text{LOAD}i}] + [V_{\text{SA}} \times I_{\text{SAA}} + (V_{\text{SA}+} - V_{\text{OUTA}}) \times I_{\text{LA}}]$$

when sourcing, and:

$$P_{\text{DMAX}} = \Sigma i \times [V_{\text{S}} \times I_{\text{SMAX}} + (V_{\text{OUT}i} - V_{\text{S}-}) \times I_{\text{LOAD}i}] + [V_{\text{SA}} \times I_{\text{SAA}} + (V_{\text{SA}+} - V_{\text{OUTA}}) \times I_{\text{LA}}]$$

when sinking.

where:

- $i = 1$ to total number of buffers
- V_S = Total supply voltage of buffer
- V_{SA} = Total supply voltage of V_{COM}
- $I_{S_{MAX}}$ = Maximum quiescent current per channel
- I_{SA} = Maximum quiescent current of V_{COM}
- V_{OUTi} = Maximum output voltage of the application
- V_{OUTA} = Maximum output voltage of V_{COM}
- I_{LOADi} = Load current of buffer
- I_{LA} = Load current of V_{COM}

If we set the two $P_{D_{MAX}}$ equations equal to each other, we can solve for the R_{LOAD} 's to avoid device overheat. The package power dissipation curves provide a convenient way to see if the device will overheat. The maximum safe power dissipation can be found graphically, based on the package type and the ambient temperature. By using the previous equation, it is a simple matter to see if $P_{D_{MAX}}$ exceeds the device's power derating curves.

Power Supply Bypassing and Printed Circuit Board Layout

As with any high frequency device, good printed circuit board layout is necessary for optimum performance. Ground plane construction is highly recommended, lead lengths should be as short as possible, and the power supply pins must be well bypassed to reduce the risk of oscillation. For normal single supply operation, where the V_S - and V_{SA} - pins are connected to ground, two 0.1 μ F ceramic capacitors should be placed from V_S + and V_{SA} + pins to ground. A 4.7 μ F tantalum capacitor should then be connected from V_S + and V_{SA} + pins to ground. One 4.7 μ F capacitor may be used for multiple devices. This same capacitor combination should be placed at each supply pin to ground if split supplies are to be used. Internally, V_S + and V_{SA} + are shorted together and V_S - and V_{SA} - are shorted together. To avoid high current density, the V_S + pin and V_{SA} + pin must be shorted in the PCB layout. Also, the V_S - pin and V_{SA} - pin must be shorted in the PCB layout.

Important Note: The metal plane used for heat sinking of the device is electrically connected to the negative supply potential (V_S - and V_{SA} -). If V_S - and V_{SA} - are tied to ground, the thermal pad can be connected to ground. Otherwise, the thermal pad must be isolated from any other power planes.

Revision History The revision history provided is for informational purposes only and is believed to be accurate, but not warranted. Please visit our website to make sure you have the latest revision.

DATE	REVISION	CHANGE
Aug 28, 2017	FN7004.4	Applied new header/footer. Updated Ordering Information table. Added Note 2. Added Revision History and About Intersil sections. Added POD L32.5X6B. Updated POD MDP0046 to the latest revision changes are as follows: -cosmetic edit added dimensions over appropriate columns. Updated POD MDP0048 to the latest revision changes are as follows: -Added dimensions (MILLIMETERS) to table

About Intersil

Intersil Corporation is a leading provider of innovative power management and precision analog solutions. The company's products address some of the largest markets within the industrial and infrastructure, mobile computing, and high-end consumer markets. For the most updated datasheet, application notes, related documentation, and related parts, see the respective product information page found at www.intersil.com. For a listing of definitions and abbreviations of common terms used in our documents, visit www.intersil.com/glossary. You can report errors or suggestions for improving this datasheet by visiting www.intersil.com/ask. Reliability reports are also available from our website at www.intersil.com/support.

© Copyright Intersil Americas LLC 2003-2017. All Rights Reserved.
 All trademarks and registered trademarks are the property of their respective owners.

For additional products, see www.intersil.com/en/products.html

Intersil products are manufactured, assembled and tested utilizing ISO9001 quality systems as noted in the quality certifications found at www.intersil.com/en/support/qualandreliability.html

Intersil products are sold by description only. Intersil may modify the circuit design and/or specifications of products at any time without notice, provided that such modification does not, in Intersil's sole judgment, affect the form, fit or function of the product. Accordingly, the reader is cautioned to verify that datasheets are current before placing orders. Information furnished by Intersil is believed to be accurate and reliable. However, no responsibility is assumed by Intersil or its subsidiaries for its use; nor for any infringements of patents or other rights of third parties which may result from its use. No license is granted by implication or otherwise under any patent or patent rights of Intersil or its subsidiaries.

For information regarding Intersil Corporation and its products, see www.intersil.com

**Quad Flat No-Lead Plastic Package (QFN)
Micro Lead Frame Plastic Package (MLFP)**

L32.5x6B (One of 10 Packages in MDP0046)

32 LEAD QUAD FLAT NO-LEAD PLASTIC PACKAGE

(COMPLIANT TO JEDEC MO-220)

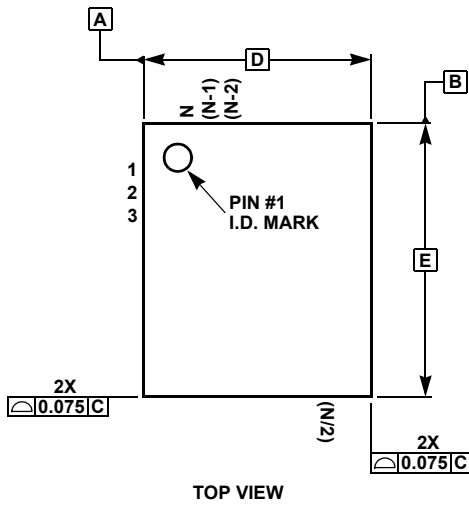

TOP VIEW

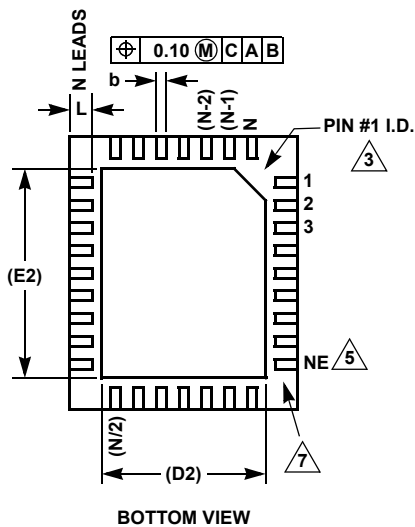

BOTTOM VIEW

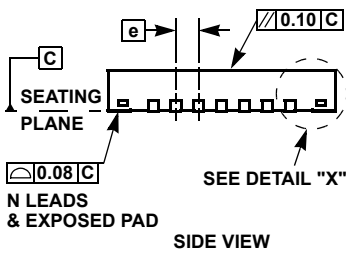

SIDE VIEW

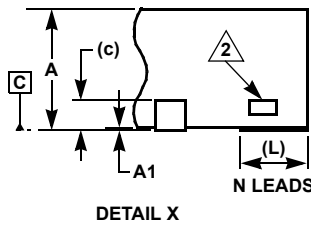

DETAIL X

SYMBOL	MILLIMETERS			NOTES
	MIN	NOMINAL	MAX	
A	0.80	0.90	1.00	-
A1	0.00	0.02	0.05	-
D	5.00 BSC			-
D2	3.60 REF			-
E	6.00 BSC			-
E2	4.60 REF			-
L	0.45	0.50	0.55	-
b	0.20	0.22	0.24	-
c	0.20 REF			-
e	0.50 BSC			-
N	32 REF			4
ND	7 REF			6
NE	9 REF			5

Rev 0 9/05

NOTES:

1. Dimensioning and tolerancing per ASME Y14.5M-1994.
2. Tiebar view shown is a non-functional feature.
3. Bottom-side pin #1 I.D. is a diepad chamfer as shown.
4. N is the total number of terminals on the device.
5. NE is the number of terminals on the "E" side of the package (or Y-direction).
6. ND is the number of terminals on the "D" side of the package (or X-direction). ND = (N/2)-NE.
7. Inward end of terminal may be square or circular in shape with radius (b/2) as shown.

For the most recent package outline drawing, see [L32.5x6B](#).

QFN (Quad Flat No-Lead) Package Family

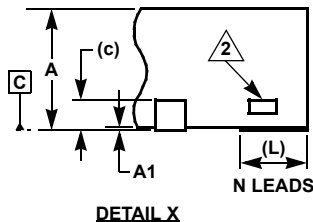
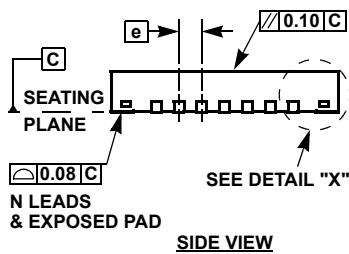
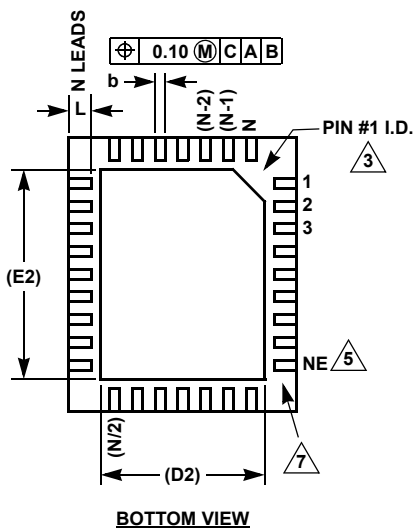
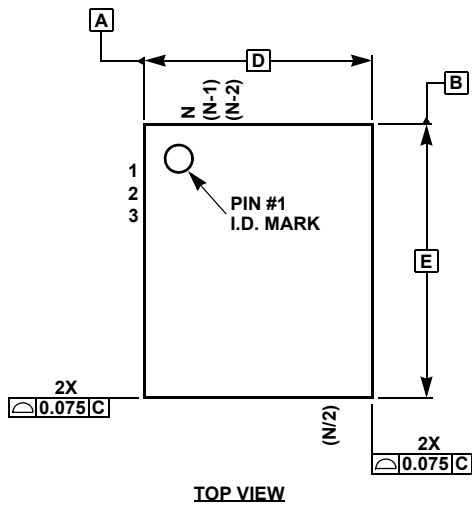

MDP0046

QFN (QUAD FLAT NO-LEAD) PACKAGE FAMILY
(COMPLIANT TO JEDEC MO-220)

SYMBOL	MILLIMETERS				TOLERANCE	NOTES
	QFN44	QFN38	QFN32			
A	0.90	0.90	0.90	0.90	±0.10	-
A1	0.02	0.02	0.02	0.02	+0.03/-0.02	-
b	0.25	0.25	0.23	0.22	±0.02	-
c	0.20	0.20	0.20	0.20	Reference	-
D	7.00	5.00	8.00	5.00	Basic	-
D2	5.10	3.80	5.80	3.60/2.48	Reference	8
E	7.00	7.00	8.00	6.00	Basic	-
E2	5.10	5.80	5.80	4.60/3.40	Reference	8
e	0.50	0.50	0.80	0.50	Basic	-
L	0.55	0.40	0.53	0.50	±0.05	-
N	44	38	32	32	Reference	4
ND	11	7	8	7	Reference	6
NE	11	12	8	9	Reference	5

SYMBOL	MILLIMETERS					TOLERANCE	NOTES
	QFN28	QFN24	QFN20		QFN16		
A	0.90	0.90	0.90	0.90	0.90	±0.10	-
A1	0.02	0.02	0.02	0.02	0.02	+0.03/-0.02	-
b	0.25	0.25	0.30	0.25	0.33	±0.02	-
c	0.20	0.20	0.20	0.20	0.20	Reference	-
D	4.00	4.00	5.00	4.00	4.00	Basic	-
D2	2.65	2.80	3.70	2.70	2.40	Reference	-
E	5.00	5.00	5.00	4.00	4.00	Basic	-
E2	3.65	3.80	3.70	2.70	2.40	Reference	-
e	0.50	0.50	0.65	0.50	0.65	Basic	-
L	0.40	0.40	0.40	0.40	0.60	±0.05	-
N	28	24	20	20	16	Reference	4
ND	6	5	5	5	4	Reference	6
NE	8	7	5	5	4	Reference	5

Rev 11 2/07

NOTES:

1. Dimensioning and tolerancing per ASME Y14.5M-1994.
2. Tiebar view shown is a non-functional feature.
3. Bottom-side pin #1 I.D. is a diepad chamfer as shown.
4. N is the total number of terminals on the device.
5. NE is the number of terminals on the "E" side of the package (or Y-direction).
6. ND is the number of terminals on the "D" side of the package (or X-direction). ND = (N/2)-NE.
7. Inward end of terminal may be square or circular in shape with radius (b/2) as shown.
8. If two values are listed, multiple exposed pad options are available. Refer to device-specific datasheet.

For the most recent package outline drawing, see [MDP0046](#).

HTSSOP (Heat-Sink TSSOP) Family

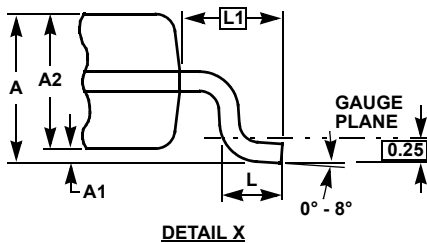
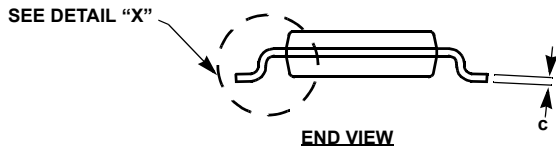
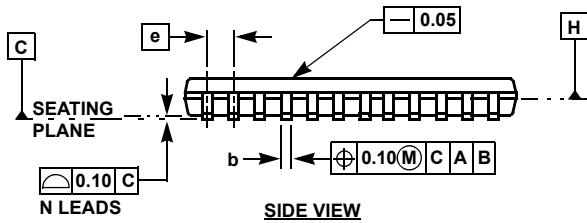
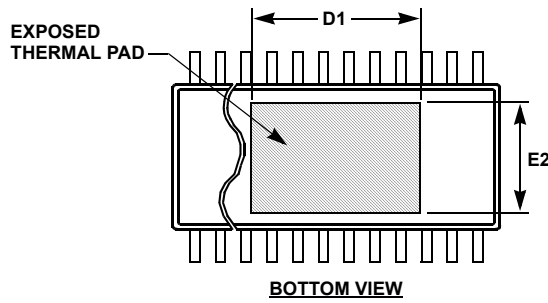
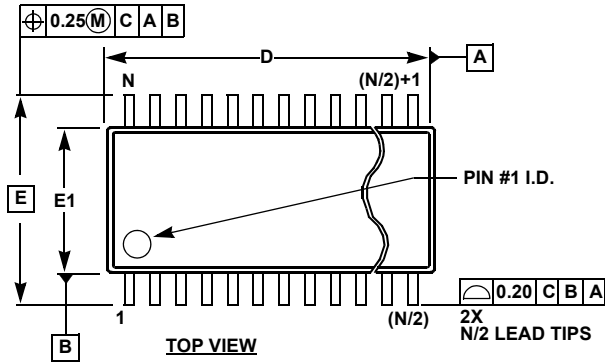

MDP0048

HTSSOP (HEAT-SINK TSSOP) FAMILY

SYMBOL	MILLIMETERS					TOLERANCE
	14 LD	20 LD	24 LD	28 LD	38 LD	
A	1.20	1.20	1.20	1.20	1.20	Max
A1	0.075	0.075	0.075	0.075	0.075	± 0.075
A2	0.90	0.90	0.90	0.90	0.90	$+0.15/-0.10$
b	0.25	0.25	0.25	0.25	0.22	$+0.05/-0.06$
c	0.15	0.15	0.15	0.15	0.15	$+0.05/-0.06$
D	5.00	6.50	7.80	9.70	9.70	± 0.10
D1	3.2	4.2	4.3	5.0	7.25	Reference
E	6.40	6.40	6.40	6.40	6.40	Basic
E1	4.40	4.40	4.40	4.40	4.40	± 0.10
E2	3.0	3.0	3.0	3.0	3.0	Reference
e	0.65	0.65	0.65	0.65	0.50	Basic
L	0.60	0.60	0.60	0.60	0.60	± 0.15
L1	1.00	1.00	1.00	1.00	1.00	Reference
N	14	20	24	28	38	Reference

Rev. 3 2/07

NOTES:

1. Dimension "D" does not include mold flash, protrusions or gate burrs. Mold flash, protrusions or gate burrs shall not exceed 0.15mm per side.
2. Dimension "E1" does not include interlead flash or protrusions. Interlead flash and protrusions shall not exceed 0.25mm per side.
3. Dimensions "D" and "E1" are measured at Datum Plane H.
4. Dimensioning and tolerancing per ASME Y14.5M-1994.

For the most recent package outline drawing, see [MDP0048](#).