

CTS100EL16

LVPECL Oscillator Gain Stage & Buffer with Enable

MLP8, MSOP8, MSOP10

FEATURES

- 250ps Propagation Delay
- High Voltage Gain vs. Standard EL16
- 75kΩ Enable Pull-down Resistor
- High Bandwidth for $\geq 1\text{GHz}$
- -147 dBc/Hz Typical Noise Floor

BLOCK DIAGRAM

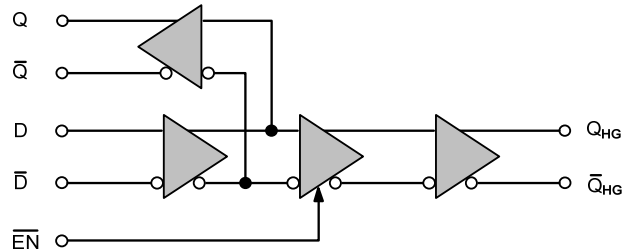

DESCRIPTION

The CTS100EL16 is an oscillator gain stage with a high gain output buffer including an enable. The Q_{HG}/\bar{Q}_{HG} outputs have a voltage gain several times greater than the Q/\bar{Q} outputs. An enable input (\bar{EN}) allows continuous oscillator operation. The \bar{EN} can be controlled by ECL or CMOS signals

ENGINEERING NOTES

The CTS100EL16 is an oscillator gain stage with a high gain output buffer including an enable. The Q_{HG}/\bar{Q}_{HG} outputs have a voltage gain several times greater than the Q/\bar{Q} outputs. An \bar{EN} allows continuous oscillator operation. When \bar{EN} is LOW or floating (NC), input data is passed to both sets of outputs. When \bar{EN} is HIGH, the Q_{HG}/\bar{Q}_{HG} outputs will be forced LOW/HIGH respectively, while input data will continue to be passed to the Q/\bar{Q} outputs. The \bar{EN} input can be driven with an ECL/PECL signal or a CMOS logic signal.

The input impedance of the D/\bar{D} inputs remain constant for all operating modes since forcing the outputs via the \bar{EN} pin does not power-down the chip but only disables the high gain Q_{HG}/\bar{Q}_{HG} outputs. Input protection diodes are included on the D/\bar{D} inputs for enhanced ESD protection.

The CTS100EL16 also provides a V_{BB} output that supports 1.5mA sink/source current. When used, the V_{BB} pin should be bypassed to ground or V_{CC} via a 0.01μF capacitor.

Any used output must have an external pull down resistor. For 3.3V operation, an 180Ω resistor to V_{EE} is recommended if an AC coupled load is present. At 5.0V, a 330Ω resistor is recommended for the AC load case. Alternately, a 50Ω load terminated to $V_{CC} - 2V$ or the Thevenin equivalent may be driven directly. Unused outputs may be left floating (NC).

10k temperature compensation is offered on the CTS100LVEL16V. If this mode is desired, connect the 10k pin to V_{EE} . The connection must be less than 1Ω.

NOTE: Specifications in ECL/PECL tables are valid when thermal equilibrium is established.

CTS100EL16

LVPECL Oscillator Gain Stage & Buffer with Enable

MLP8, MSOP8, MSOP10

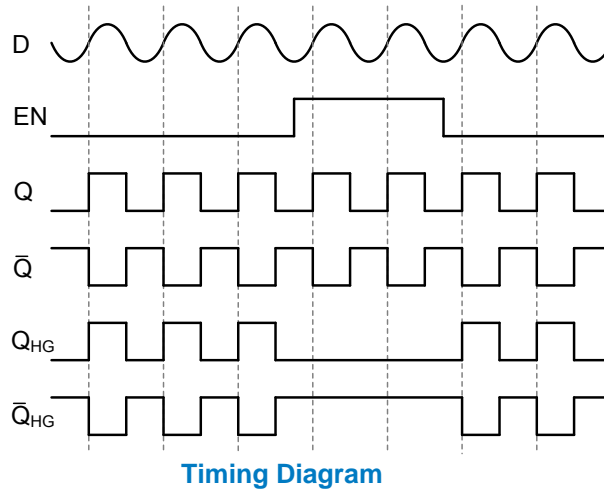

Enable Truth Table

EN	Q/ \bar{Q}	Q _{HG}	\bar{Q} _{HG}
LOW or NC	Data	Data	Data
HIGH	Data	LOW	HIGH

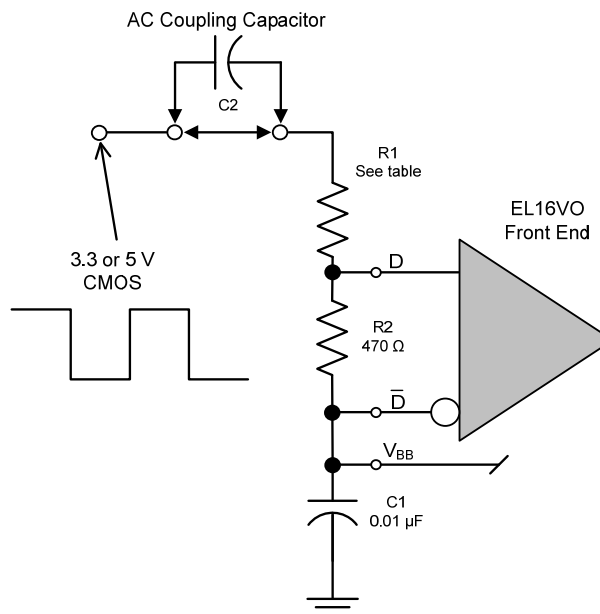

Recommended Component Values for CMOS Single Ended Inputs

Input Type	R1 ¹ Value	
	AC Coupled (C2 in circuit)	DC Coupled (C2 shorted)
3.3V CMOS	430Ω	750Ω
5.0V CMOS	910Ω	1.8kΩ

R1 should be chosen so that the input swing on the D input with respect to \bar{D} is in the range of ± 80 to ± 1000 mV, per the AC Characteristics table and the D input is $< \pm 750$ mV with respect to V_{BB} .

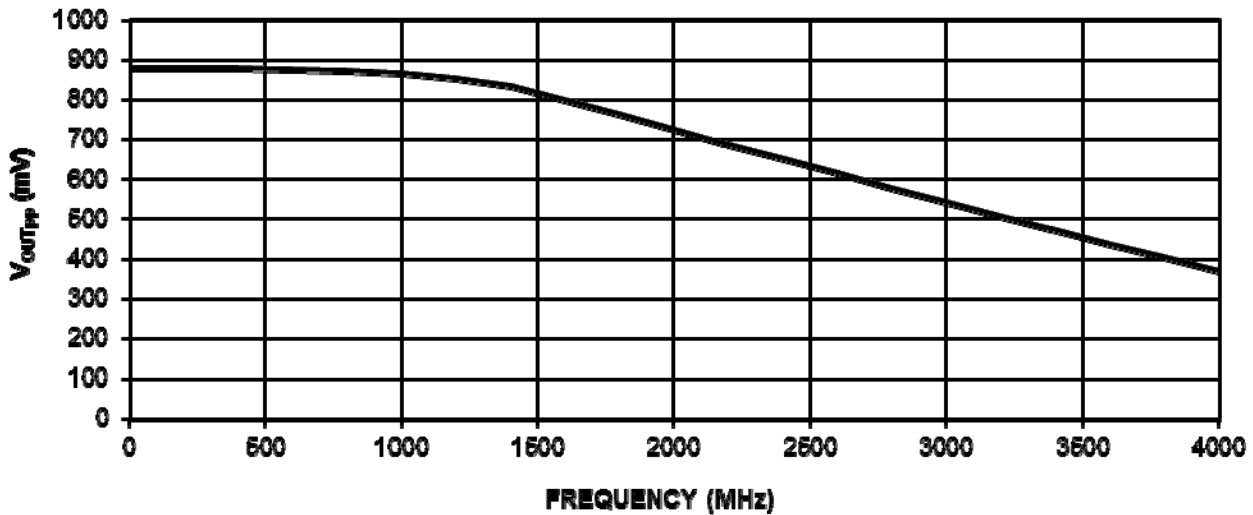

Typical Large Signal Output Swing

Measured with 750mV differential input, V_{EEP} NC, Q_{HG}/\bar{Q}_{HG} each terminated to $V_{CC}-2V$ via 50Ω resistors.

CTS100EL16

LVPECL Oscillator Gain Stage & Buffer with Enable

MLP8, MSOP8, MSOP10

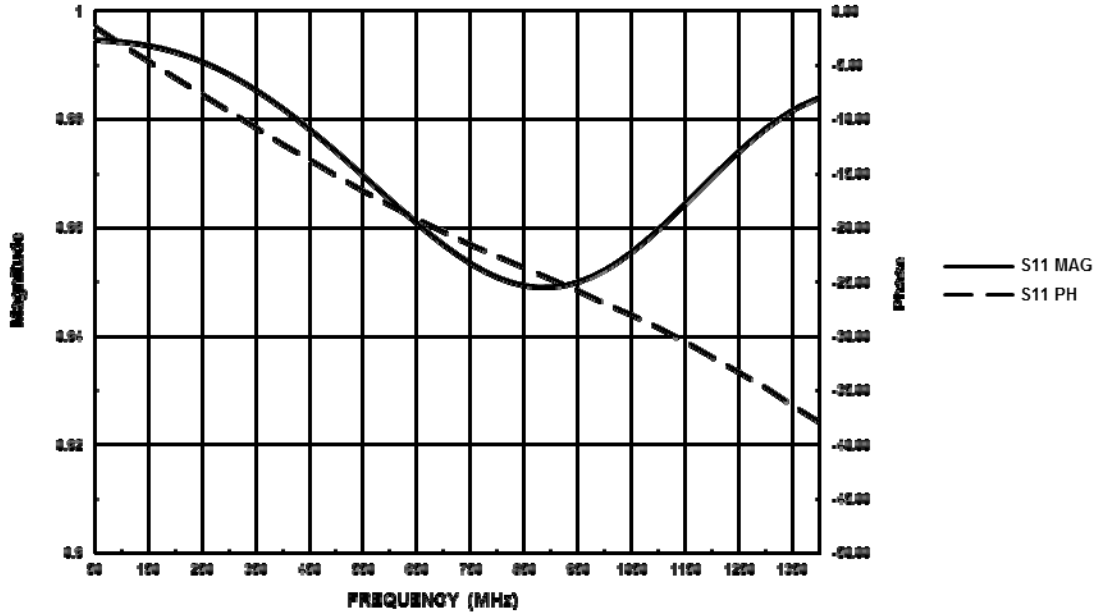

S11, 50Ω load to VCC -2V

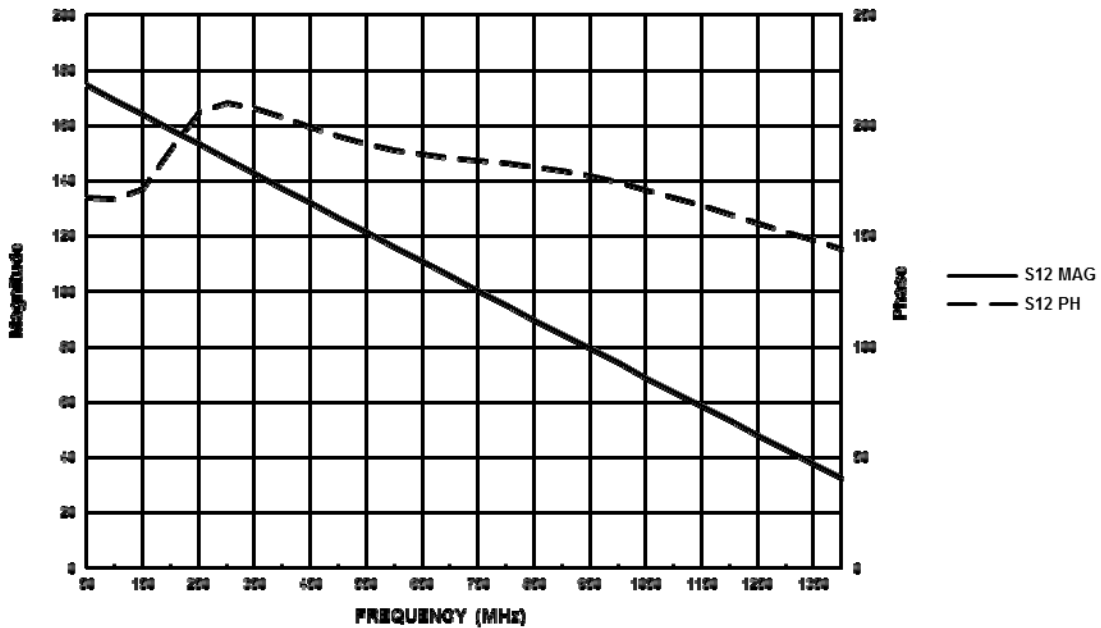

S12, 50Ω load to VCC -2V

CTS100EL16

LVPECL Oscillator Gain Stage & Buffer with Enable

MLP8, MSOP8, MSOP10

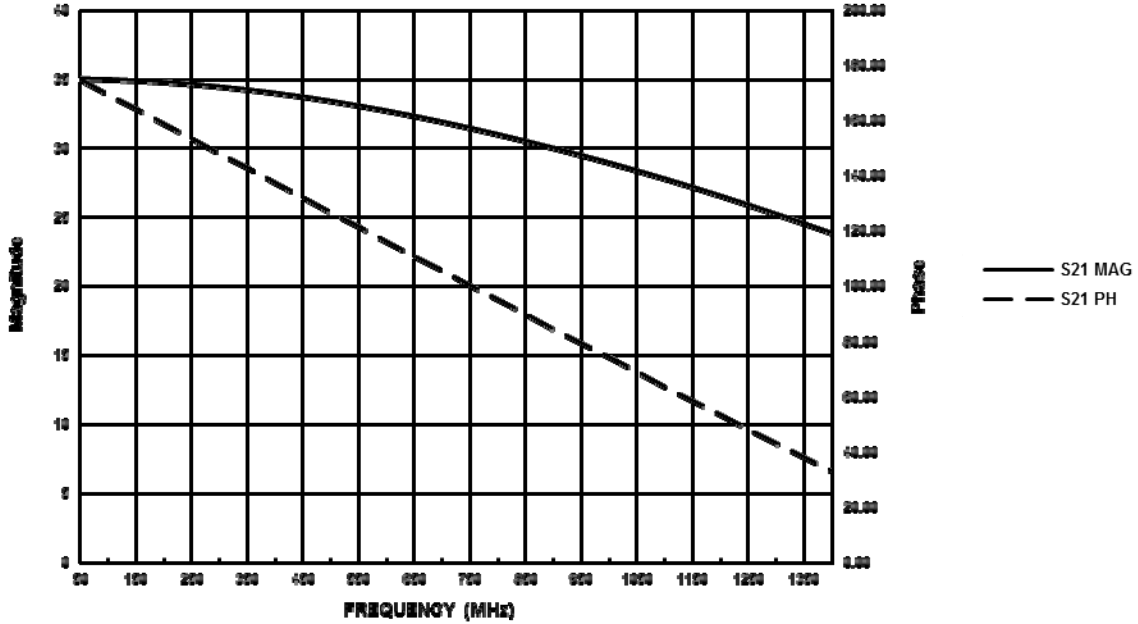

S21, 50Ω load to VCC -2V

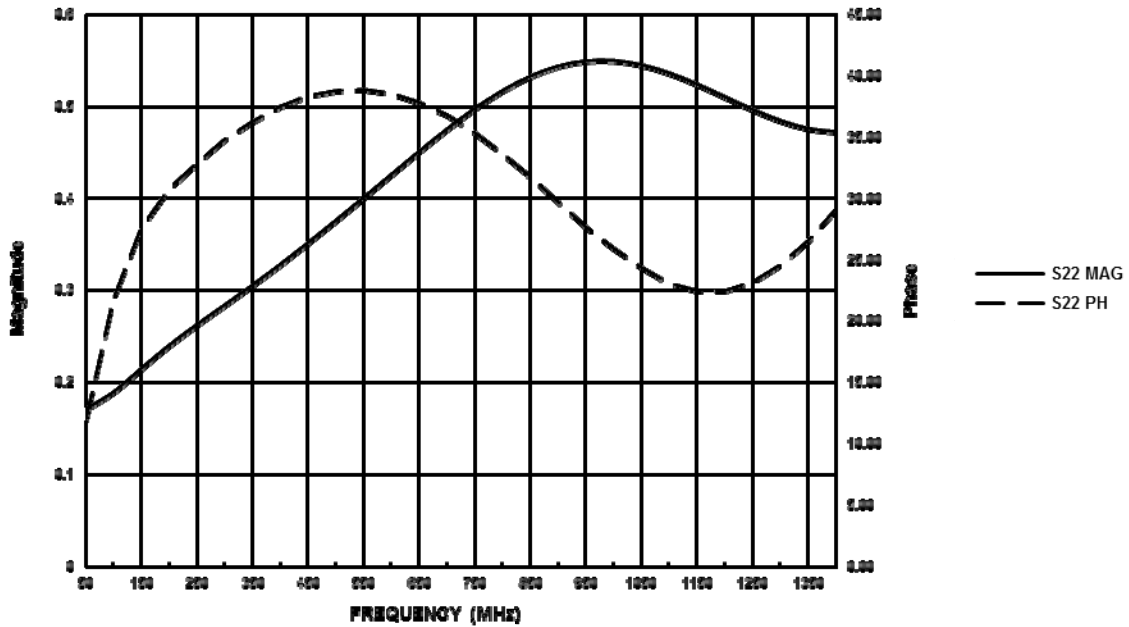

S22, 50Ω load to VCC -2V

ELECTRICAL SPECIFICATIONS

Absolute Maximum Ratings are those values beyond which device life may be impaired.

Symbol	Characteristic	Condition	Rating	Unit
V_{CC}	PECL Power Supply	$V_{EE} = 0V$	0 to + 6.0	V
V_{I_PECL}	PECL Input Voltage	$V_{EE} = 0V$	0 to + 6.0	V
V_{EE}	ECL Power Supply	$V_{CC} = 0V$	-6.0 to 0	V
V_{I_ECL}	ECL Input Supply	$V_{CC} = 0V$	-6.0 to 0	V
V_{I_DIFF}	Differential Input Voltage		0 to ± 1.6	V_{PP}^1
I_{OUT}	Output Current	Continuous	50	mA
		Surge	100	
T_A	Operating Temperature Range	-	-40 to +85 ²	°C
T_{STG}	Storage Temperature Range	-	-65 to +150	°C
ESD _{HBM}	Human Body Model Electro Static Discharge	-	2500	V
ESD _{MM}	Machine Model Electro Static Discharge	-	200	V
ESD _{CDM}	Charged Device Model Electro Static Discharge	-	2000	V

¹ V_{I_DIFF} is the voltage difference between D and \bar{D} .

10K ECL DC Characteristics ($V_{EE} = -3.0V$ to $-5.5V$, $V_{CC} = GND$)

Symbol	Characteristic	-40°C		0°C		25°C		85°C		Unit
		Min	Max	Min	Max	Min	Max	Min	Max	
V_{OH}	Output HIGH Voltage ¹	-1080	-890	-1020	-840	-980	-810	-910	-720	mV
V_{OL}	Output LOW Voltage ¹	-1950	-1650	-1950	-1630	-1950	-1630	-1950	-1595	mV
V_{IH}	Input HIGH Voltage D/ \bar{D}	-1230	-430	-1170	-380	-1130	-360	-1060	-310	mV
	Input HIGH Voltage $\bar{E}N$	-1230	V_{CC}	-1170	V_{CC}	-1130	V_{CC}	-1060	V_{CC}	mV
V_{IL}	Input LOW Voltage D/ \bar{D}	-2300	-1500	-2260	-1480	-2240	-1480	-2190	-1445	mV
	Input LOW Voltage $\bar{E}N$	V_{EE}	-1500	V_{EE}	-1480	V_{EE}	-1480	V_{EE}	-1445	mV
V_{BB}	Reference Voltage	-1430	-1300	-1380	-1260	-1360	-1240	-1310	-1190	mV
I_{IH}	Input HIGH Current D/ \bar{D}		60		60		60		60	μA
	Input HIGH Current EN		150		150		150		150	μA
I_{IL}	Input LOW Current	0.5		0.5		0.5		0.5		μA
I_{EE}	Power Supply Current		40		40		40		40	mA

¹ Specified with each output terminated through 50Ω resistors to $V_{CC} - 2V$.

10K LVPECL DC Characteristics (VEE = GND, VCC = +3.3V)

Symbol	Characteristic	-40°C		0°C		25°C		85°C		Unit
		Min	Max	Min	Max	Min	Max	Min	Max	
V _{OH}	Output HIGH Voltage ^{1,2}	2220	2410	2280	2460	2320	2490	2390	2580	mV
V _{OL}	Output LOW Voltage ^{1,2}	1350	1650	1350	1670	1350	1670	1350	1705	mV
V _{IH}	Input HIGH Voltage D/ \bar{D} ¹	2070	2870	2130	2920	2170	2940	2240	2990	mV
	Input HIGH Voltage $\bar{E}N$	2070	V _{CC}	2130	V _{CC}	2170	V _{CC}	2240	V _{CC}	mV
V _{IL}	Input LOW Voltage D/ \bar{D} ¹	1000	1800	1040	1820	1060	1820	1110	1855	mV
	Input LOW Voltage $\bar{E}N$	V _{EE}	1800	V _{EE}	1820	V _{EE}	1820	V _{EE}	1825	mV
V _{BB}	Reference Voltage ¹	1870	2000	1920	2040	1940	2060	1990	2110	mV
I _{IH}	Input HIGH Current D/ \bar{D}		60		60		60		60	μA
	Input HIGH Current $\bar{E}N$		150		150		150		150	μA
I _{IL}	Input LOW Current D/ \bar{D}	0.5		0.5		0.5		0.5		μA
	Input LOW Current $\bar{E}N$ ³	-300		-300		-300		-300		μA
I _{EE}	Power Supply Current		40		40		40		46	mA

- 1 For supply voltages other than 3.3V, use the ECL table values and ADD supply voltage value.
- 2 Specified with each output terminated through 50Ω resistors to V_{CC} -2V.
- 3 Specified with forced to V_{EE}.

10K PECL DC Characteristics (VEE = GND, VCC = +5.0V)

Symbol	Characteristic	-40°C		0°C		25°C		85°C		Unit
		Min	Max	Min	Max	Min	Max	Min	Max	
V _{OH}	Output HIGH Voltage ^{1,2}	3920	4110	3980	4160	4020	4190	4090	4280	mV
V _{OL}	Output LOW Voltage ^{1,2}	3050	3350	3050	3370	3050	3370	3050	3405	mV
V _{IH}	Input HIGH Voltage D/ \bar{D} ¹	3770	4570	3830	4620	3870	4640	3940	4690	mV
	Input HIGH Voltage $\bar{E}N$	3770	V _{CC}	3830	V _{CC}	3870	V _{CC}	3940	V _{CC}	mV
V _{IL}	Input LOW Voltage D/ \bar{D} ¹	2700	3500	2740	3520	2760	3520	2810	3555	mV
	Input LOW Voltage $\bar{E}N$	V _{EE}	3500	V _{EE}	3520	V _{EE}	3520	V _{EE}	3555	mV
V _{BB}	Reference Voltage ¹	3570	3700	3620	3740	3640	3760	3690	3810	mV
I _{IH}	Input HIGH Current D/ \bar{D}		60		60		60		60	μA
	Input HIGH Current $\bar{E}N$		150		150		150		150	μA
I _{IL}	Input LOW Current D/ \bar{D}	0.5		0.5		0.5		0.5		μA
	Input LOW Current $\bar{E}N$ ³	-1400		-1400		-1400		-1400		μA
I _{EE}	Power Supply Current		40		40		40		40	mA

- 1 For supply voltages other than 3.3V, use the ECL table values and ADD supply voltage value.
- 2 Specified with each output terminated through 50Ω resistors to V_{CC} -2V.
- 3 Specified with forced to V_{EE}.

100K ECL DC Characteristics (VEE = -3.0V to -5.5V, VCC = GND)

Symbol	Characteristic	-40°C		0°C		25°C		85°C		Unit
		Min	Max	Min	Max	Min	Max	Min	Max	
V _{OH}	Output HIGH Voltage ¹	-1085	-880	-1025	-880	-1025	-880	-1025	-880	mV
V _{OL}	Output LOW Voltage ¹	-1900	-1555	-1900	-1620	-1900	-1620	-1900	-1620	mV
V _{IH}	Input HIGH Voltage D/ \bar{D}	-1165	-390	-1165	-390	-1165	-390	-1165	-390	mV
	Input HIGH Voltage $\bar{E}N$	-1165	V _{CC}	-1165	V _{CC}	-1165	V _{CC}	-1165	V _{CC}	mV
V _{IL}	Input LOW Voltage D/ \bar{D}	-2250	-1475	-2250	-1475	-2250	-1475	-2250	-1475	mV
	Input LOW Voltage $\bar{E}N$	V _{EE}	-1475	V _{EE}	-1475	V _{EE}	-1475	V _{EE}	-1475	mV
V _{BB}	Reference Voltage	-1390	-1250	-1390	-1250	-1390	-1250	-1390	-1250	mV
I _{IH}	Input HIGH Current D/ \bar{D}		60		60		60		60	μA
	Input HIGH Current $\bar{E}N$		150		150		150		150	μA
I _{IL}	Input LOW Current	0.5		0.5		0.5		0.5		μA
I _{EE}	Power Supply Current		40		40		40		46	mA

¹ Specified with each output terminated through 50Ω resistors to V_{CC} -2V.

100K LVPECL DC Characteristics (VEE = GND, VCC = +3.3V)

Symbol	Characteristic	-40°C		0°C		25°C		85°C		Unit
		Min	Max	Min	Max	Min	Max	Min	Max	
V _{OH}	Output HIGH Voltage ^{1,2}	2215	2420	2275	2420	2275	2420	2275	2420	mV
V _{OL}	Output LOW Voltage ^{1,2}	1400	1745	1400	1680	1400	1680	1400	1680	mV
V _{IH}	Input HIGH Voltage D/ \bar{D} ¹	2135	2910	2135	2910	2135	2910	2135	2910	mV
	Input HIGH Voltage $\bar{E}N$	2135	V _{CC}	2135	V _{CC}	2135	V _{CC}	2135	V _{CC}	mV
V _{IL}	Input LOW Voltage D/ \bar{D} ¹	1050	1825	1050	1825	1050	1825	1050	1825	mV
	Input LOW Voltage $\bar{E}N$	V _{EE}	1825	V _{EE}	1825	V _{EE}	1825	V _{EE}	1825	mV
V _{BB}	Reference Voltage ¹	1910	2050	1910	2050	1910	2050	1910	2050	mV
I _{IH}	Input HIGH Current D/ \bar{D}		60		60		60		60	μA
	Input HIGH Current $\bar{E}N$		150		150		150		150	μA
I _{IL}	Input LOW Current D/ \bar{D}	0.5		0.5		0.5		0.5		μA
	Input LOW Current $\bar{E}N$ ³	-300		-300		-300		-300		μA
I _{EE}	Power Supply Current		40		40		40		46	mA

¹ For supply voltages other than 3.3V, use the ECL table values and ADD supply voltage value.

² Specified with each output terminated through 50Ω resistors to V_{CC} -2V.

³ Specified with forced to V_{EE}.

LVPECL Oscillator Gain Stage & Buffer with Enable

MLP8, MSOP8, MSOP10

100K PECL DC Characteristics (VEE = GND, VCC = +5.0V)

Symbol	Characteristic	-40°C		0°C		25°C		85°C		Unit
		Min	Max	Min	Max	Min	Max	Min	Max	
V _{OH}	Output HIGH Voltage ^{1,2}	3915	4120	3975	4120	3975	4120	3975	4120	mV
V _{OL}	Output LOW Voltage ^{1,2}	3100	3445	3100	3380	3100	3380	3100	3380	mV
V _{IH}	Input HIGH Voltage D/ \bar{D} ¹	3835	4610	3835	4610	3835	4610	3835	4610	mV
	Input HIGH Voltage $\bar{E}N$	3835	V _{CC}	3835	V _{CC}	3835	V _{CC}	3835	V _{CC}	mV
V _{IL}	Input LOW Voltage D/ \bar{D} ¹	2750	3525	2750	3525	2750	3525	2750	3525	mV
	Input LOW Voltage $\bar{E}N$	V _{EE}	3525	V _{EE}	3525	V _{EE}	3525	V _{EE}	3525	mV
V _{BB}	Reference Voltage ¹	3610	3750	3610	3750	3610	3750	3610	3750	mV
I _{IH}	Input HIGH Current D/ \bar{D}		60		60		60		60	μA
	Input HIGH Current $\bar{E}N$		150		150		150		150	μA
I _{IL}	Input LOW Current D/ \bar{D}	0.5		0.5		0.5		0.5		μA
	Input LOW Current $\bar{E}N$ ³	-1400		-1400		-1400		-1400		μA
I _{EE}	Power Supply Current		40		40		40		46	mA

- For supply voltages other than 3.3V, use the ECL table values and ADD supply voltage value.
- Specified with each output terminated through 50Ω resistors to V_{CC} -2V.
- Specified with forced to V_{EE}.

AC Characteristics (VEE = -3.0V to -5.5V; VCC=GND or VEE=GND; VCC = +3.0V to +5.5V)

Symbol	Characteristic	-40°C			0°C			25°C			85°C			Unit
		Min	Typ	Max	Min	Typ	Max	Min	Typ	Max	Min	Typ	Max	
t _{PLH} /t _{PHL}	Propagation Delay													
	D to Q/ \bar{Q}	100		300	100		300	100	200	300	100		300	ps
	D to Q _{HG} / \bar{Q} _{HG}	150		450	150		450	150	290	450	150		450	ps
t _{SKREW}	Duty Cycle Skew ¹		5	20		5	20		5	20		5	20	ps
V _{PP} (AC)	Input Swing ²	80		1000	80		1000	80		1000	80		1000	mV
t _r /t _f	Output Rise/Fall (20% - 80%)	80		240	80		240	80	135	240	80		240	ps

- Duty cycle skew is the difference between a t_{PLH} and t_{PHL} propagation delay through a device.
- V_{PP} is the peak-to-peak differential input swing for which AC parameters are guaranteed. The device has a voltage gain of ≈20 to Q/ \bar{Q} outputs and a voltage gain of ≈100 to Q_{HG}/ \bar{Q} _{HG} outputs.

CTS100EL16

LVPECL Oscillator Gain Stage & Buffer with Enable

MLP8, MSOP8, MSOP10

PACKAGE DIMENSIONS

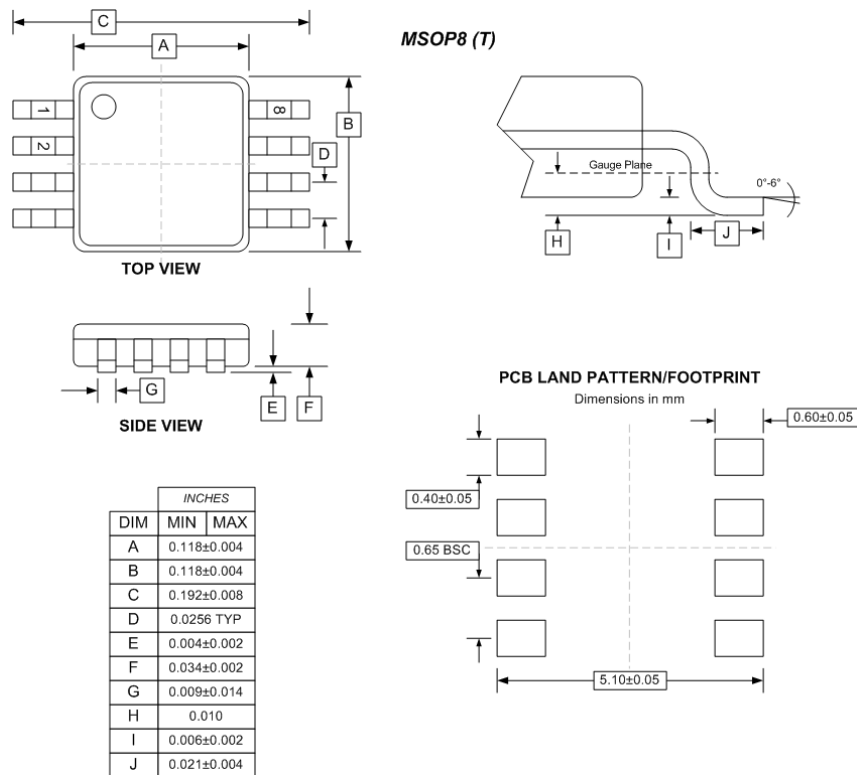
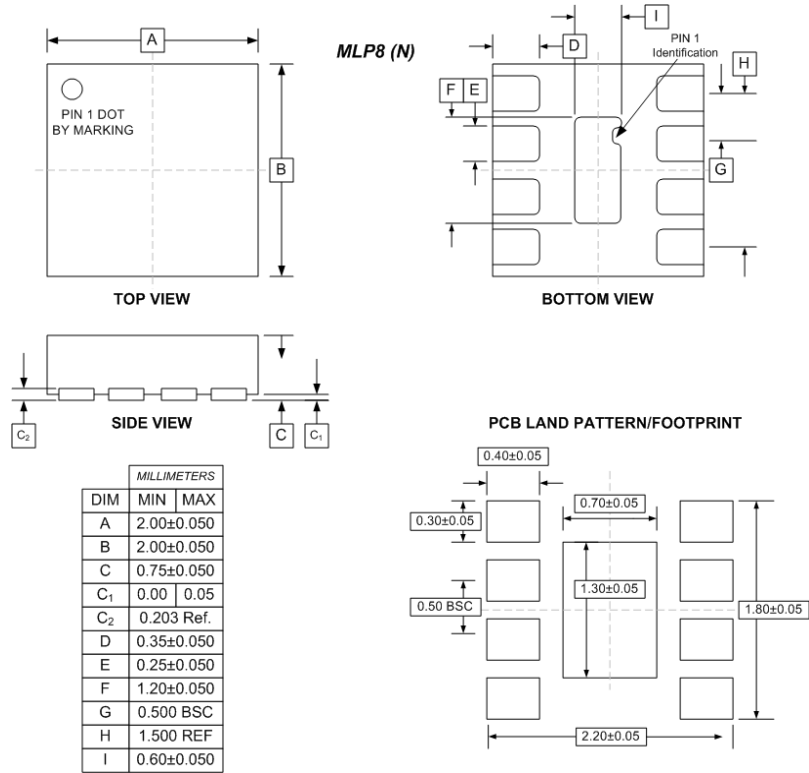

CTS100EL16

LVPECL Oscillator Gain Stage & Buffer with Enable

MLP8, MSOP8, MSOP10

PACKAGE DIMENSIONS

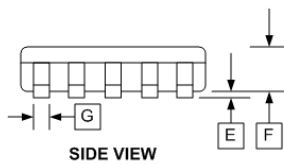
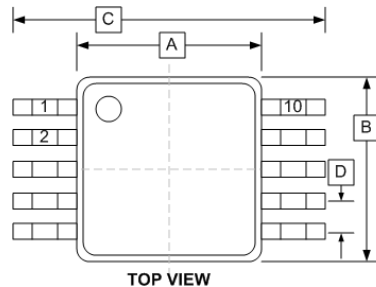

DIM	INCHES	
	MIN	MAX
A	0.118±0.004	
B	0.118±0.004	
C	0.192±0.008	
D	0.0197 TYP	
E	0.004±0.002	
F	0.034±0.002	
G	0.007±0.0106	
H	0.010	
I	0.006±0.002	
J	0.021±0.004	

MSOP10 (U)

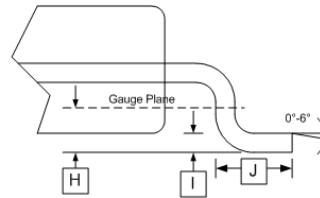

PCB LAND PATTERN/FOOTPRINT

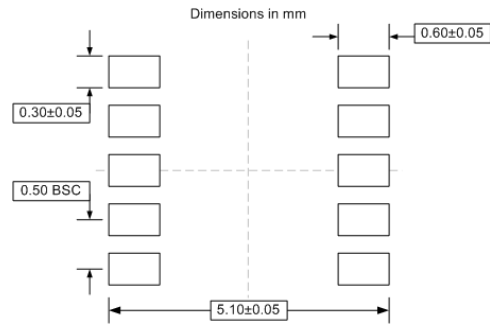

Pin Description and Configuration

Pin Assignments for CTS100EL16VONG

Pin	Name	Type	Function
1	D	Input	Data Input
2	V _{BB}	Output	Reference Voltage
3	EN	Input	Output Enable
4	V _{EE}	Power	Negative Supply
5	Q _{HG}	Output	High Gain Inverting PECL Output
6	Q _{HG}	Output	High Gain PECL Output
7	V _{CC}	Power	Positive Supply
8	Q	Output	Inverting PECL Output

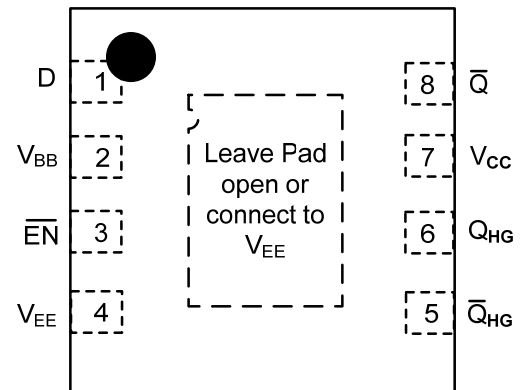

CTS100EL16VONG (MLP8)

CTS100EL16

LVPECL Oscillator Gain Stage & Buffer with Enable

MLP8, MSOP8, MSOP10

Pin Assignments for CTS100EL16VOTG

Pin	Name	Type	Function
1	\bar{Q}	Output	Inverting PECL Output
2	D	Input	Data Input
3	V_{BB}	Output	Reference Voltage
4	\bar{EN}	Input	Output Enable
5	V_{EE}	Power	Negative Supply
6	\bar{Q}_{HG}	Output	High Gain Inverting PECL Output
7	Q_{HG}	Output	High Gain PECL Output
8	V_{CC}	Power	Positive Supply

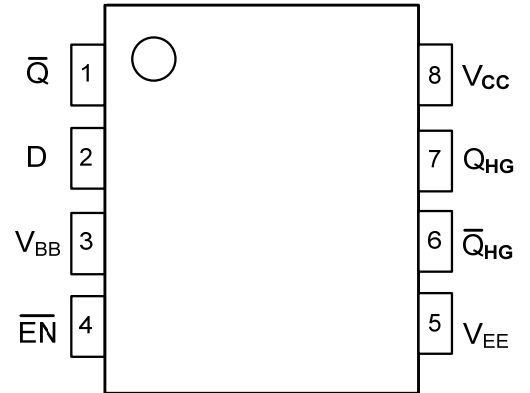

CTS100EL100VOTG (MSOP8)

Pin Assignments for CTS100EL16VOUG

Pin	Name	Type	Function
1	Q	Output	PECL Output
2	\bar{Q}	Output	Inverting PECL Output
3	D	Input	Data Input
4	\bar{D}	Input	Inverting Data Input
5	V_{BB}	Output	Reference Voltage
6	\bar{EN}	Input	Output Enable
7	V_{EE}	Power	Negative Supply
8	\bar{Q}_{HG}	Output	High Gain Inverting PECL Output
9	Q_{HG}	Output	High Gain PECL Output
10	V_{CC}	Power	Positive Supply

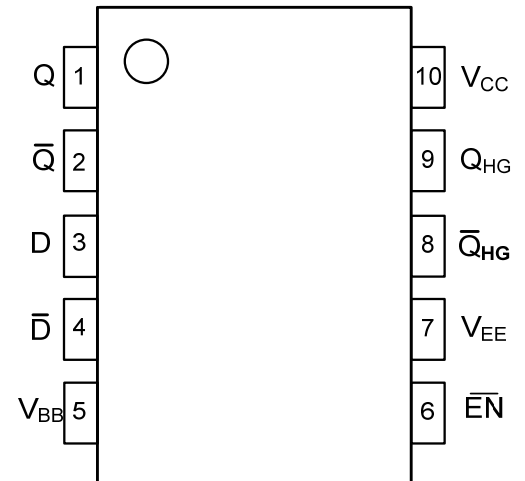

CTS100EL16VOUG (MSOP10)

PART ORDERING INFORMATION

Part Number (PN)	Package	Marking
CTS100EL16VONG	MLP8	POG / YWW
CTS100EL16VOTG	MSOP8	HVOG / YYWW
CTS100EL16VOUG	MSOP10	HVOUG / YYWW