

# AUIPS7081(R)(S)

## INTELLIGENT POWER HIGH SIDE SWITCH

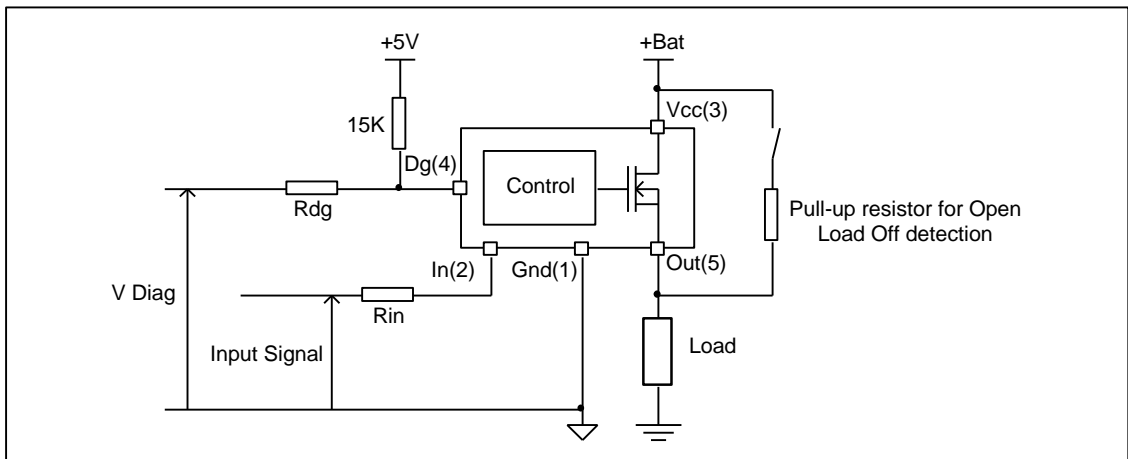
### Features

- Over temperature shutdown (with auto-restart)
- Short circuit protection (current limit)
- Active clamp
- Open load detection
- Logic ground isolated from power ground
- ESD protection
- Ground loss protection
- Status feedback

### Description

The AUIPS7081(R)(S) is a five terminal Intelligent Power Switch (IPS) with built in short circuit, over-temperature, ESD protection, inductive load capability and diagnostic feedback. The output current is limited at  $I_{lim}$  value. Current limitation is activated until the thermal protection acts. The over-temperature protection turns off the device if the junction temperature exceeds  $T_{shutdown}$ . It will automatically restart after the junction has cooled  $7^{\circ}\text{C}$  below  $T_{shutdown}$ . A diagnostic pin is provided for status feedback of short circuit, over-temperature and open load detection. The double level shifter circuitry allows large offsets between the logic ground and the load.

### Typical Connection



### Product Summary

$R_{ds(on)}$	70m $\Omega$ max.
$V_{clamp}$	70V
I Limit	5A (typ.)
Open load	3V

### Package



TO220  
AUIPS7081



D<sup>2</sup>Pak  
AUIPS7081S



D-Pak  
AUIPS7081R

## Qualification Information†

<b>Qualification Level</b>		Automotive (per AEC-Q100)	
		Comments: This family of ICs has passed an Automotive qualification. IR's Industrial and Consumer qualification level is granted by extension of the higher Automotive level.	
<b>Moisture Sensitivity Level</b>		D2PAK-5L	MSL1, 260°C (per IPC/JEDEC J-STD-020)
		TO-220	Not applicable (non-surface mount package style)
		DPAK-5L	MSL1, 260°C (per IPC/JEDEC J-STD-020)
<b>ESD</b>	Machine Model	Class M2 (+/-200V) (per AEC-Q100-003)	
	Human Body Model	Class H2 (+/-4000V) (per AEC-Q100-002)	
	Charged Device Model	Class C4 (+/-1000V) (per AEC-Q100-011)	
<b>IC Latch-Up Test</b>		Class II, Level A (per AEC-Q100-004)	
<b>RoHS Compliant</b>		Yes	

† Qualification standards can be found at International Rectifier's web site <http://www.irf.com/>

## Absolute Maximum Ratings

Absolute maximum ratings indicate sustained limits beyond which damage to the device may occur. All voltage parameters are referenced to Ground lead.  $T_j = -40^{\circ}\text{C}..150^{\circ}\text{C}$ ,  $V_{cc}=6..35\text{V}$  (unless otherwise specified).

Symbol	Parameter	Min.	Max.	Units
Vout	Maximum output voltage	$V_{cc}-63$	$V_{cc}+0.3$	V
Voffset	Maximum logic ground to load ground offset	$V_{cc}-63$	$V_{cc}+0.3$	
Vin	Maximum input voltage	-0.3	5.5	
Vcc max.	Maximum Vcc voltage	—	60	
Vcc cont.	Maximum continuous Vcc voltage	—	35	
Vcc sc	Maximum Vcc voltage with short circuit protection	—	24	
Iin max.	Maximum IN current	-1	10	mA
I <sub>dg</sub> max.	Maximum diagnostic output current	-1	10	
V <sub>dg</sub>	Maximum diagnostic output voltage	-0.3	5.5	V
P <sub>d</sub>	Maximum power dissipation (internally limited by thermal protection) R <sub>th</sub> =50°C/W	—	2.5	W
I <sub>sd</sub> cont.	Maximum continuous diode current (R <sub>th</sub> =50°C/W)	—	2.2	A
ESD1	Electrostatic discharge voltage (Human body) 100pF, 1500Ω	—	4	kV
ESD2	Electrostatic discharge voltage (Machine Model) C=200pF,R=0Ω,L=10μH	—	0.5	
T <sub>j</sub> max.	Max. storage & operating temperature junction temperature	-40	+150	°C

## Thermal Characteristics

Symbol	Parameter	Typ.	Max.	Units
R <sub>th1</sub>	Thermal resistance junction to ambient D-Pak std. footprint	70	—	°C/W
R <sub>th2</sub>	Thermal resistance junction to ambient D-Pak 1" sqrt. footprint	50	—	
R <sub>th3</sub>	Thermal resistance junction to case D-Pak / TO220 / D <sup>2</sup> Pak	3	—	
R <sub>th1</sub>	Thermal resistance junction to ambient TO220 free air	60	—	

## Recommended Operating Conditions

These values are given for a quick design. For operation outside these conditions, please consult the application notes.

Symbol	Parameter	Min.	Max.	Units
V <sub>IH</sub>	High level input voltage	4	5.5	V
V <sub>IL</sub>	Low level input voltage	-0.3	0.9	
I <sub>out</sub>	Continuous drain current, T <sub>amb</sub> =85°C, T <sub>j</sub> =125°C, V <sub>in</sub> =5V, R <sub>th</sub> =50°C/W	—	2.3	A
R <sub>in</sub>	Recommended resistor in series with IN pin	4	10	kΩ
R <sub>dg</sub>	Recommended resistor in series with DG pin	10	20	
R <sub>ol</sub>	Recommended pull-up resistor for open load detection	5	100	

## Static Electrical Characteristics

T<sub>j</sub>=-40..150°C, V<sub>cc</sub>=6..35V (unless otherwise specified), typical values are given for V<sub>cc</sub>=14V and T<sub>j</sub>=25°C

Symbol	Parameter	Min.	Typ.	Max.	Units	Test Conditions
R <sub>ds(on)</sub>	ON state resistance T <sub>j</sub> =25°C	—	55	70	mΩ	V <sub>in</sub> =5V, I <sub>out</sub> =2A
	ON state resistance T <sub>j</sub> =150°C	—	100	130		V <sub>in</sub> =5V, I <sub>out</sub> =2A
	ON state resistance T <sub>j</sub> =25°C, V <sub>cc</sub> =6.5V	—	60	80		V <sub>in</sub> =5V, I <sub>out</sub> =2A
V <sub>cc op.</sub>	Operating voltage range	6	—	35	V	
V <sub>clamp</sub>	V <sub>cc</sub> to Out clamp voltage	63	70	—		I <sub>out</sub> =30mA (see Fig. 1)
V <sub>f</sub>	Body diode forward voltage	—	1	1.4		I <sub>out</sub> = 2.5A
I <sub>cc Off</sub>	Supply current when Off T <sub>j</sub> =25°C	—	2.5	10	μA	V <sub>in</sub> =0V, V <sub>out</sub> =0V
I <sub>cc On</sub>	Supply current when On	—	2.5	4	mA	V <sub>in</sub> =5V, V <sub>cc</sub> =14V
I <sub>out@0V</sub>	Output leakage current	—	2.5	10	μA	V <sub>out</sub> =0V
I <sub>out@6V</sub>	Output leakage current	—	20	—		V <sub>out</sub> =6V
I <sub>dg leakage</sub>	Diagnostic output leakage current	—	—	10		V <sub>dg</sub> =5.5V
V <sub>dgl</sub>	Low level diagnostic output voltage	—	0.1	0.3	V	I <sub>dg</sub> =1.6mA
V <sub>ih</sub>	Input high threshold voltage	—	2.5	3.5		
V <sub>il</sub>	Input low threshold voltage	1	2	—		
I <sub>n hys</sub>	Input hysteresis	0.05	0.5	1		
UV high	Under voltage high threshold voltage	—	5	6.2		
UV low	Under voltage low threshold voltage	3	4.5	5.9		
UV hys	Under voltage hysteresis	0.1	0.5	1.5		
I <sub>in On</sub>	Input current when device is On	—	40	80		μA

## Switching Electrical Characteristics

V<sub>cc</sub>=14V, Resistive load=6Ω, V<sub>in</sub>=5V, T<sub>j</sub>=-40°C..150°C, typical values are given for T<sub>j</sub>=25°C

Symbol	Parameter	Min.	Typ.	Max.	Units	Test Conditions
T <sub>don</sub>	Turn-on delay time	—	16	45	μs	See Fig. 3
T <sub>r1</sub>	Rise time to V <sub>out</sub> =V <sub>cc</sub> -5V	—	10	50		
T <sub>r2</sub>	Rise time to V <sub>out</sub> =0.9 x V <sub>cc</sub>	—	20	100		
dV/dt (On)	Turn On dV/dt	—	0.8	3	V/μs	
E <sub>On</sub>	Turn On energy	—	100	—	μJ	
T <sub>doff</sub>	Turn-off delay time	—	25	50	μs	
T <sub>f</sub>	Fall time to V <sub>out</sub> =0.1 x V <sub>cc</sub>	—	7.5	25		
dV/dt (Off)	Turn Off dV/dt	—	1.6	3.5	V/μs	
E <sub>Off</sub>	Turn Off energy	—	25	—	μJ	
T <sub>diag</sub>	V <sub>out</sub> to V <sub>diag</sub> propagation delay	—	15	—	μs	See Fig. 4 and Fig. 12

## Protection Characteristics

$T_j = -40..150^{\circ}\text{C}$ ,  $V_{cc} = 6..35\text{V}$  (unless otherwise specified), typical values are given for  $V_{cc} = 14\text{V}$  and  $T_j = 25^{\circ}\text{C}$

Symbol	Parameter	Min.	Typ.	Max.	Units	Test Conditions
Ilim	Internal current limit	2	5	13.5	A	$V_{out} = 0\text{V}$ , $T_j = 25^{\circ}\text{C}$
Tsd+	Over temperature high threshold	150 <sup>(1)</sup>	165	—	°C	See Fig. 2
Tsd-	Over temperature low threshold	—	158	—		
Vsc	Short-circuit detection voltage <sup>(2)</sup>	2	3	4	V	
Vopen load	Open load detection threshold	2	3	4		

<sup>(1)</sup> Guaranteed by design

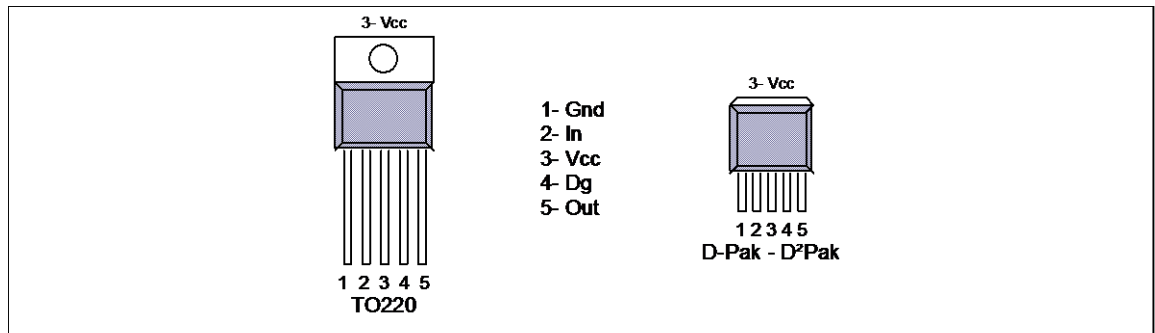
<sup>(2)</sup> Reference to  $V_{cc}$

## Truth Table

Operating Conditions	IN	OUT	DG pin
Normal	H	H	H
Normal	L	L	L
Open Load	H	H	H
Open Load <sup>(3)</sup>	L	H	H
Short circuit to Gnd	H	L (limiting)	L
Short circuit to Gnd	L	L	L
Over-temperature	H	L (cycling)	L
Over-temperature	L	L	L

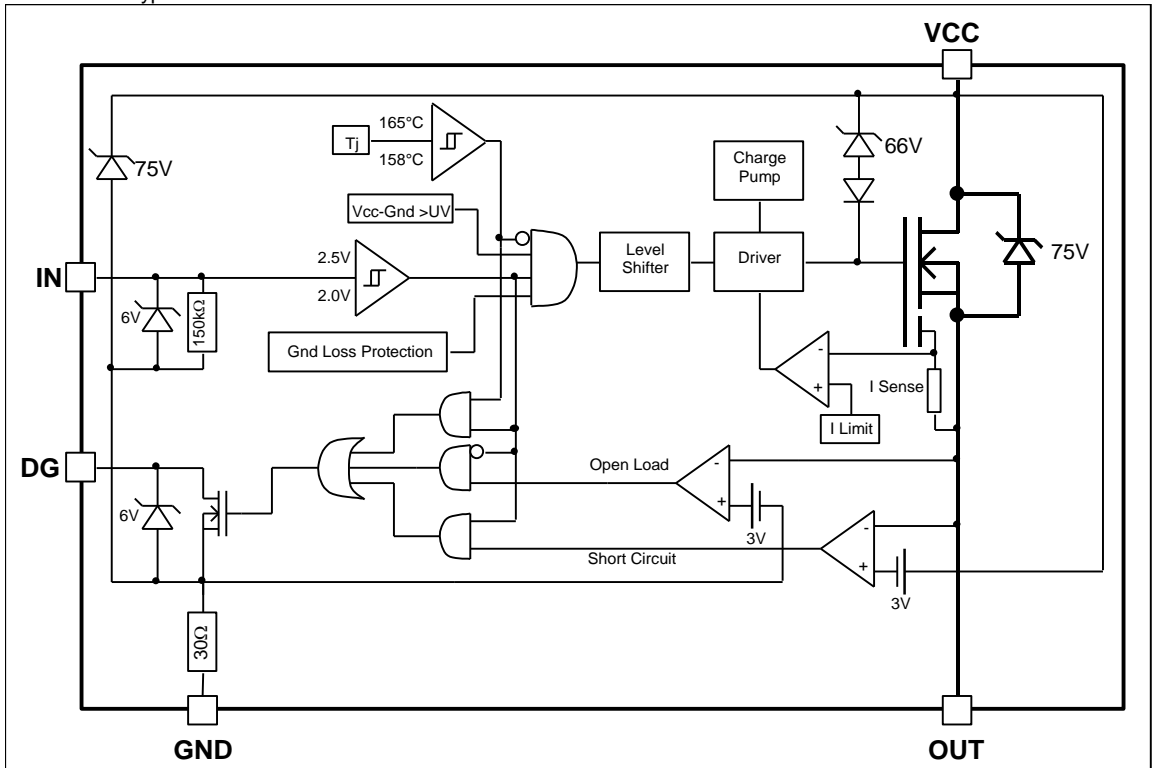
<sup>(3)</sup> With a pull-up resistor connected between the output and  $V_{cc}$ .

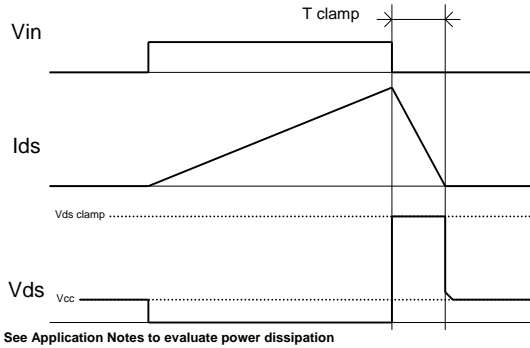
## Lead Assignments



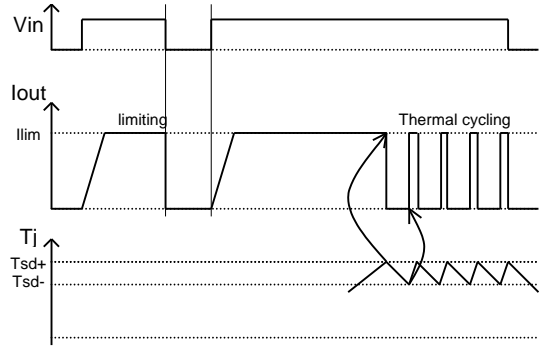
## Functional Block Diagram

All values are typical

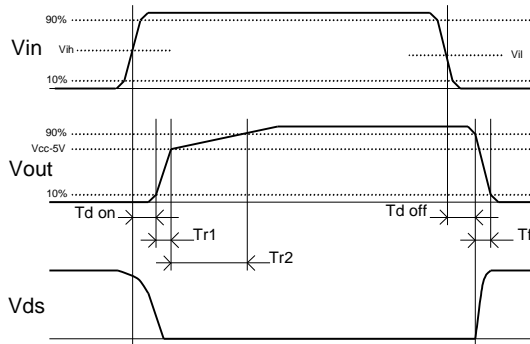




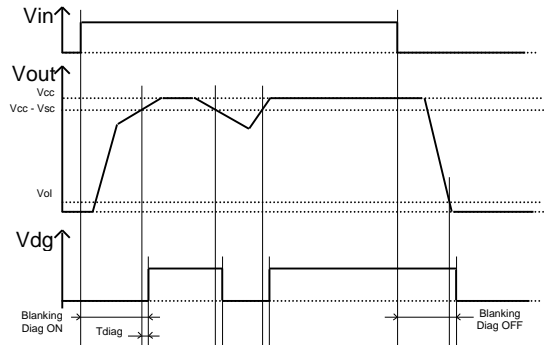
**Figure 1 – Active clamp waveforms**



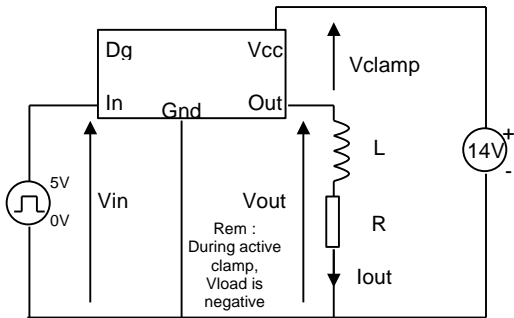
**Figure 2 – Protection timing diagram**



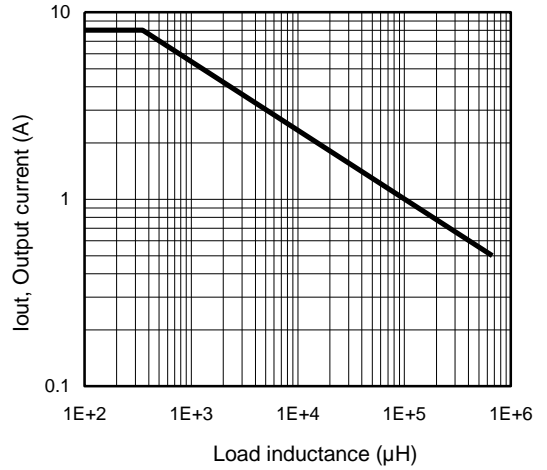
**Figure 3 – Switching times definition**



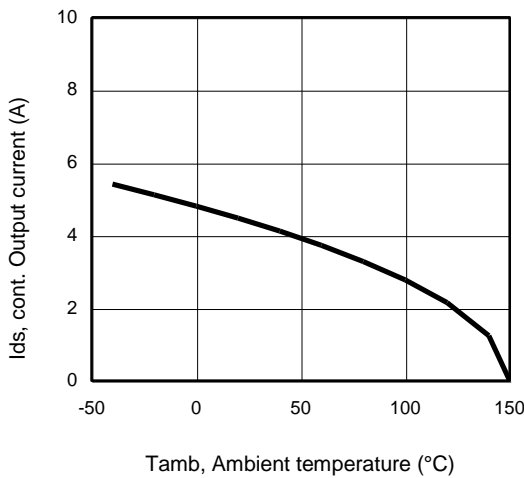
**Figure 4 – Diagnostic delay definition**



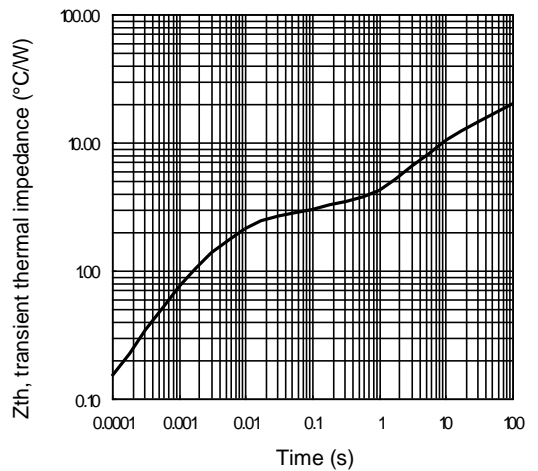
**Figure 5 – Active clamp test circuit**



**Figure 6 – Max. Output current (A) Vs Load inductance (µH)**

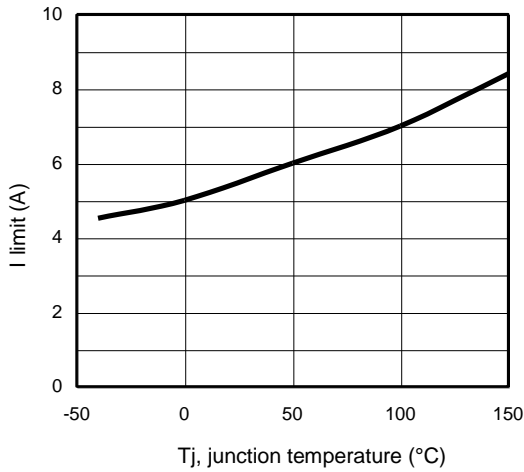


**Figure 7 – Max. output current (A) Vs Ambient temperature (°C) Rth=50°C/W**

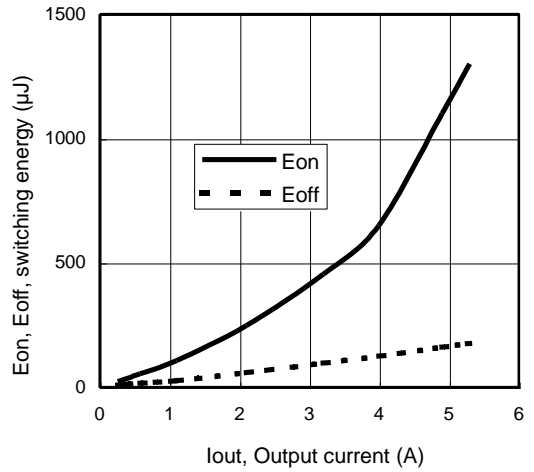


**Figure 8 – Transient thermal impedance (°C/W) Vs time (s)**

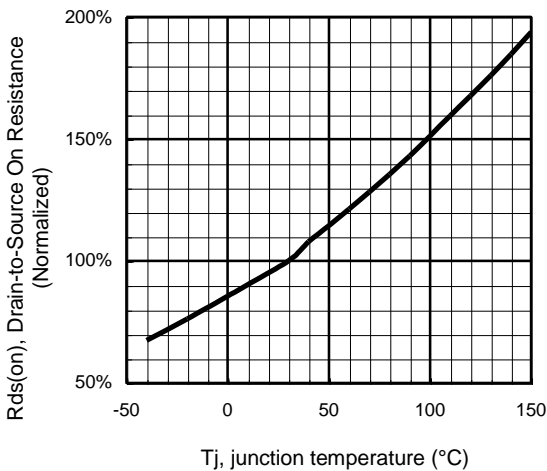




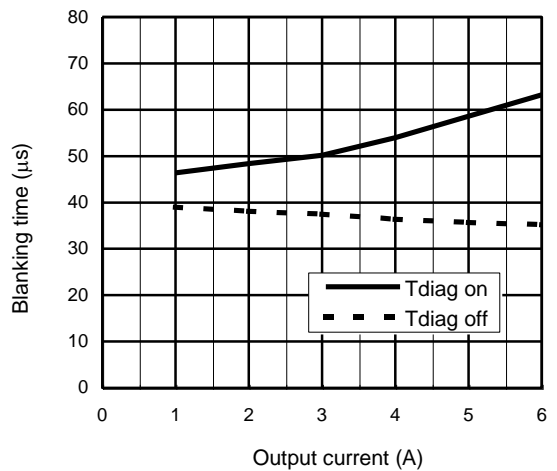
**Figure 9 – I limit (A) Vs junction temperature (°C)**



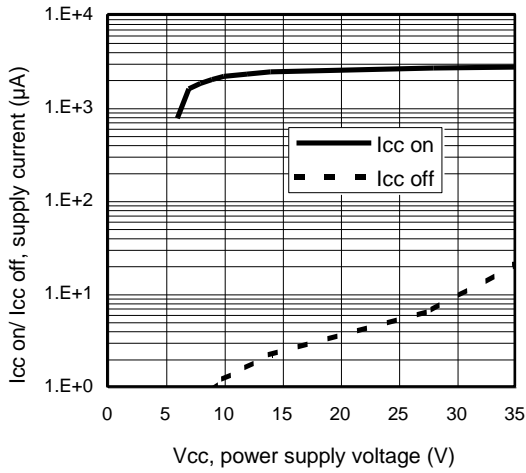
**Figure 10 – Switching energy (µJ) Vs Output current (A)**



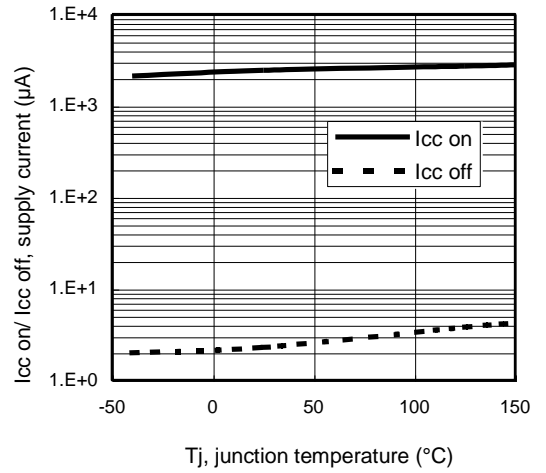
**Figure 11 - Normalized R<sub>ds(on)</sub> (%) Vs T<sub>j</sub> (°C)**



**Figure 12 – Diagnostic Blanking time (µs) Vs Output current (A)**

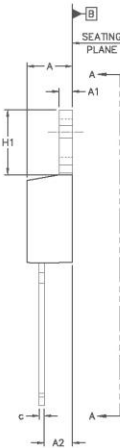
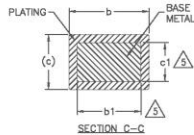
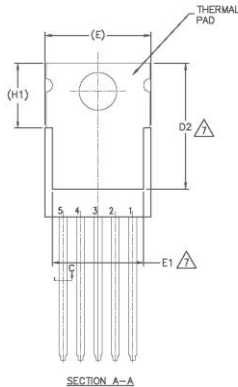
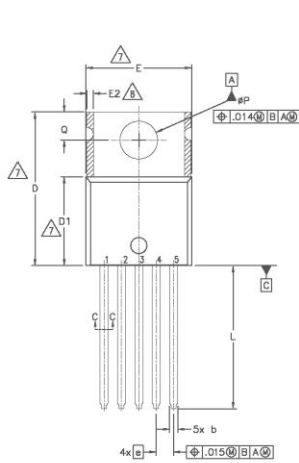


**Figure 13 – I<sub>cc on</sub>/ I<sub>cc off</sub> (µA) Vs V<sub>cc</sub> (V)**



**Figure 14 – I<sub>cc on</sub>/ I<sub>cc off</sub> (µA) Vs T<sub>j</sub> (°C)**

## Case outline – TO220 – 5 leads

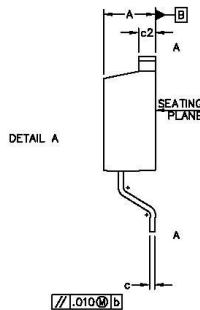
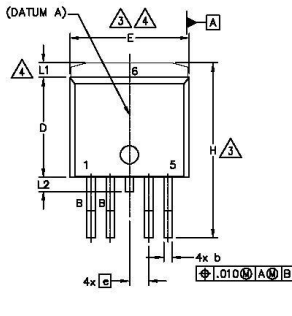
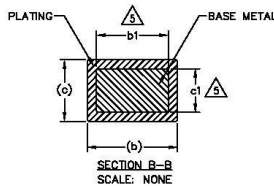
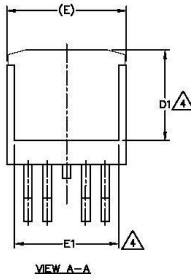
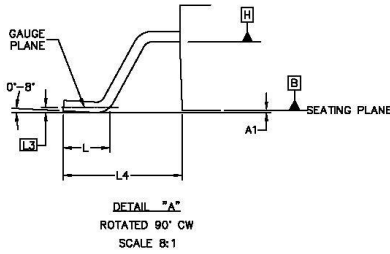


SYMBOL	DIMENSIONS				NOTES	
	MILLIMETERS		INCHES			
	MIN.	MAX.	MIN.	MAX.		
A	3.56	4.83	.140	.190	5	
A1	0.51	1.40	.020	.055		
A2	2.03	2.92	.080	.115		
b	0.64	0.89	.025	.035		
b1	0.64	0.84	.025	.033		
c	0.36	0.61	.014	.024		
c1	0.36	0.56	.014	.022		5
D	14.22	16.51	.560	.650		4
D1	8.36	9.02	.330	.355		7
D2	11.68	12.86	.460	.507		
E	9.65	10.67	.380	.420	4,7	
E1	6.86	8.89	.270	.350	7	
E2	-	0.76	-	.030	8	
e	1.70 BSC		.067 BSC		7,8	
H1	5.84	6.86	.230	.270		
L	12.70	14.73	.500	.580		
ϕP	3.53	3.73	.139	.147		
D	2.54	3.05	.100	.120		

**NOTES:**

- 1.- DIMENSIONING AND TOLERANCING AS PER ASME Y14.5 M-1994.
- 2.- DIMENSIONS ARE SHOWN IN INCHES [MILLIMETERS].
- 3.- LEAD DIMENSION AND FINISH UNCONTROLLED IN L1.
- 4.- DIMENSION D, D1 & E DO NOT INCLUDE MOLD FLASH. MOLD FLASH SHALL NOT EXCEED .005" (0.127) PER SIDE. THESE DIMENSIONS ARE MEASURED AT THE OUTERMOST EXTREMES OF THE PLASTIC BODY.
- 5.- DIMENSION b1 & c1 APPLY TO BASE METAL ONLY.
- 6.- CONTROLLING DIMENSION - INCHES.
- 7.- THERMAL PAD CONTOUR OPTIONAL WITHIN DIMENSIONS E1,D2 & E1
- 8.- DIMENSION E2 X H1 DEFINE A ZONE WHERE STAMPING AND SINGULATION IRREGULARITIES ARE ALLOWED.
- 9.- OUTLINE CONFORMS TO JEDEC TO-220, EXCEPT A2 (max.) AND D2 (min.) WHERE DIMENSIONS ARE DERIVED FROM THE ACTUAL PACKAGE OUTLINE.
- 10.- LEADS AND DRAIN ARE PLATED WITH 100% Sn

## Case Outline – D<sup>2</sup>pak – 5 leads

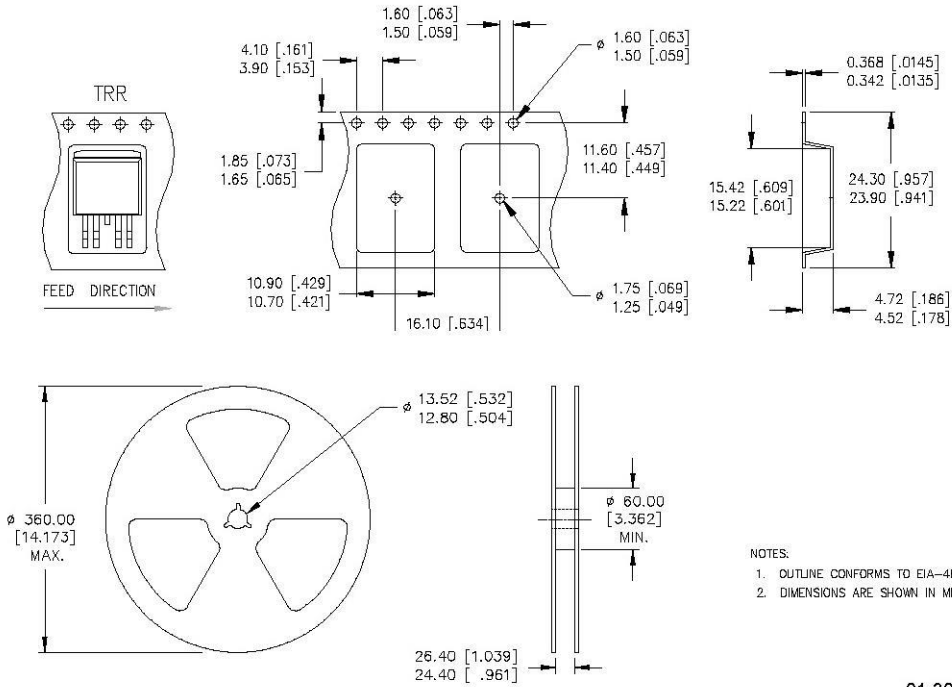


**NOTES:**

1. DIMENSIONING AND TOLERANCING AS PER ASME Y14.5M-1994
2. DIMENSIONS ARE SHOWN IN MILLIMETERS [INCHES].
3. DIMENSION D & E DO NOT INCLUDE MOLD FLASH. MOLD FLASH SHALL NOT EXCEED 0.127 [.005"] PER SIDE. THESE DIMENSIONS ARE MEASURED AT THE OUTMOST EXTREMES OF THE PLASTIC BODY AT DATUM H.
4. THERMAL PAD CONTOUR OPTIONAL WITHIN DIMENSION E, L1, D1 & E1.
5. DIMENSION b1 AND c1 APPLY TO BASE METAL ONLY.
6. DATUM A & B TO BE DETERMINED AT DATUM PLANE H.
7. CONTROLLING DIMENSION: INCH.
8. OUTLINE CONFORMS TO JEDEC OUTLINE TO-263BA.
9. LEADS AND DRAIN ARE PLATED : 100% Sn

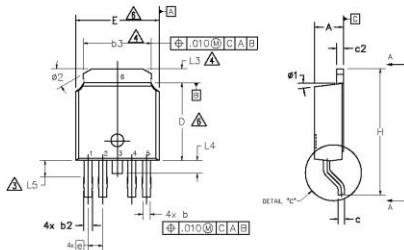
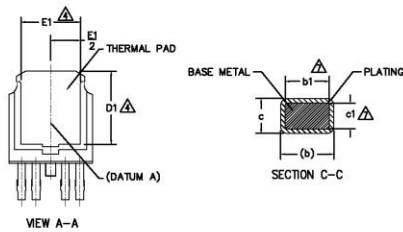
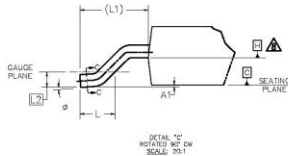
SYM BO L	DIMENSIONS				NO TE S
	MILLIMETERS		INCHES		
	MIN.	MAX.	MIN.	MAX.	
A	4.06	4.83	.160	.190	4
A1	-	0.254	-	.010	
b	0.51	0.99	.020	.039	
b1	0.51	0.89	.020	.035	
c	0.38	0.74	.015	.029	4
c1	0.38	0.58	.015	.023	
c2	1.14	1.65	.045	.065	3
D	8.38	9.65	.330	.380	
D1	6.86	-	.270	-	3
E	9.65	10.87	.380	.420	
E1	6.22	-	.245	-	
e	1.70 BSC		.067 BSC		
H	14.61	15.88	.575	.625	
L	1.78	2.79	.070	.110	
L1	-	1.68	-	.066	
L2	-	1.78	-	.070	
L3	0.25 BSC		.010 BSC		
L4	4.78	5.28	.188	.208	

## Tape and Reel – D<sup>2</sup>Pak – 5 leads



01-3071 00 / 01-3072 00

## Case Outline – Dpak – 5 leads

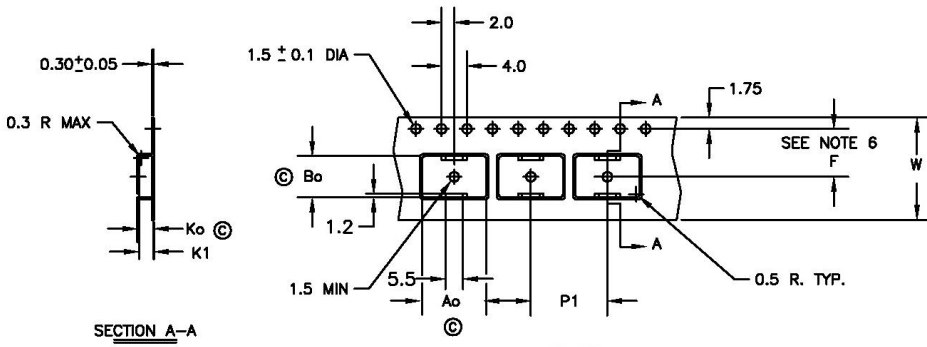


SYMBOL	DIMENSIONS				NOTES
	MILLIMETERS		INCHES		
	MIN.	MAX.	MIN.	MAX.	
A	2.18	2.39	.086	.094	
A1	—	0.13	—	.005	
b	0.51	0.89	.020	.035	2
b1	.051	0.84	.020	.033	2
b3	4.95	5.46	.195	.215	
c	0.46	0.61	.018	.024	
c1	0.41	0.56	.016	.022	2
c2	0.46	0.89	.018	.035	
D	5.97	6.22	.235	.245	3
D1	5.21	—	.205	—	
E	6.35	6.73	.250	.265	3
E1	4.32	—	.170	—	
e	1.14 BSC		.045 BSC		
H	9.40	10.41	.370	.410	
L	1.40	1.78	.055	.070	
L1	2.74 BSC		.108 REF.		
L2	0.51 BSC		.020 BSC		
L3	0.89	1.27	.035	.050	
L4	—	1.02	—	.040	
L5	1.14	1.52	.045	.060	
ø	0"	10"	0"	10"	
ø1	0"	15"	0"	15"	
ø2	28"	32"	28"	32"	

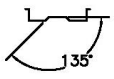
**NOTES:**

- 1.— DIMENSIONING AND TOLERANCING AS PER ASME Y14.5M-1994
- 2.— DIMENSIONS ARE SHOWN IN INCHES [MILLIMETERS].
- 3.— LEAD DIMENSION UNCONTROLLED IN L5.
- 4.— DIMENSION D1, E1, L3 & b3 ESTABLISH A MINIMUM MOUNTING SURFACE FOR THERMAL PAD.
- 5.— SECTION C-C DIMENSIONS APPLY TO THE FLAT SECTION OF THE LEAD BETWEEN .005 AND 0.10 [0.13 AND 0.25] FROM THE LEAD TIP.
- 6.— DIMENSION D & E DO NOT INCLUDE MOLD FLASH. MOLD FLASH SHALL NOT EXCEED .005 [0.13] PER SIDE. THESE DIMENSIONS ARE MEASURED AT THE OUTMOST EXTREMES OF THE PLASTIC BODY.
- 7.— DIMENSION b1 & c1 APPLIED TO BASE METAL ONLY.
- 8.— DATUM A & B TO BE DETERMINED AT DATUM PLANE H.
- 9.— OUTLINE CONFORMS TO JEDEC OUTLINE TO-252.
10. LEADS AND DRAIN ARE PLATED WITH 100% Sn

**Tape & Reel – Dpak – 5 leads**



SECTION A-A

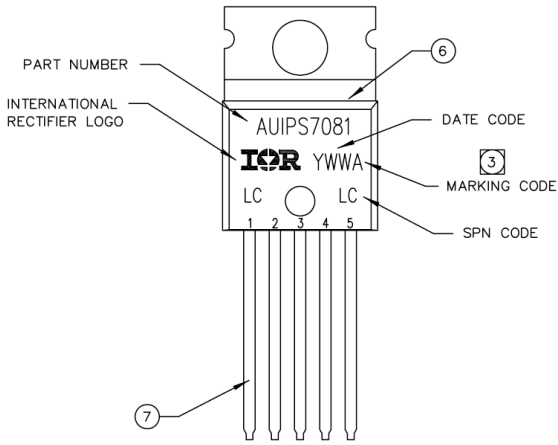


- Ao = 10.5 mm
- Bo = 7.0 mm
- Ko = 2.8 mm
- K1 = 2.4 mm
- F = 7.5 mm
- P1 = 12.0 mm
- W = 16.0 ± .3 mm

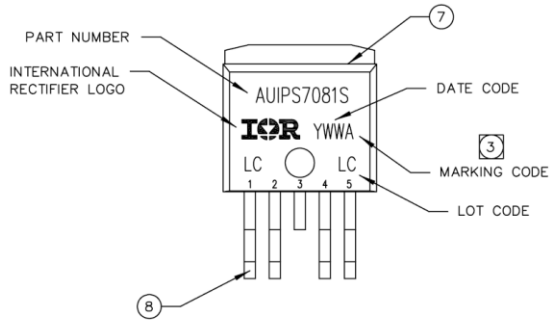
NOTES:

1. 10 SPROCKET HOLE PUNCH CUMULATIVE TOLERANCE ±.02
2. CAMBER NOT TO EXCEED 1mm IN 100mm
3. MATERIAL: CONDUCTIVE BLACK POLYSTYRENE
4. Ao AND Bo MEASURED ON A PLANE 0.3mm ABOVE THE BOTTOM OF THE POCKET
5. Ko MEASURED FROM A PLANE ON THE INSIDE BOTTOM OF THE POCKET TO THE TOP SURFACE OF THE CARRIER
6. POCKET POSITION RELATIVE TO THE SPROCKET HOLE MEASURED AS TRUE POSITION OF POCKET, NOT POCKET HOLE
7. VENDOR: (OPTIONAL)
8. MUST ALSO MEET REQUIREMENTS OF EIA STANDARD #EIA-481A, TAPING OF SURFACE-MOUNT COMPONENTS FOR AUTOMATIC PLACEMENT.
9. TOLERANCE TO BE MANUFACTURER STANDARD
10. SURFACE RESISTIVITY OF MOLDED MATL: MUST MEASURE LESS THAN OR EQUAL TO 10<sup>8</sup> OHMS PER SQUARE. MEASURED IN ACCORDANCE TO PROCEDURE GIVEN IN ASTM D-257 & ASTM D-991 (REF. C-9000 SPEC.)
11. TOTAL LENGTH PER REEL MUST BE 79 METERS
12. © CRITICAL DIMENSION

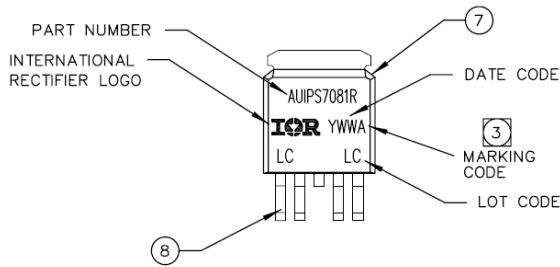
## Part Marking Information



TOP MARKING (LASER)



TOP MARKING (LASER)



TOP MARKING (LASER)



## Ordering Information

Base Part Number	Package Type	Standard Pack		Complete Part Number
		Form	Quantity	
AUIPS7081	TO220-5-Leads	Tube	50	AUIPS7081
AUIPS7081S	D2-Pak-5-Leads	Tube	50	AUIPS7081S
		Tape and reel left	800	AUIPS7081STRL
AUIPS7081R	D-Pak-5-Leads	Tube	75	AUIPS7081R
		Tape and reel left	3000	AUIPS7081RTRL

## IMPORTANT NOTICE

Unless specifically designated for the automotive market, International Rectifier Corporation and its subsidiaries (IR) reserve the right to make corrections, modifications, enhancements, improvements, and other changes to its products and services at any time and to discontinue any product or services without notice. Part numbers designated with the "AU" prefix follow automotive industry and / or customer specific requirements with regards to product discontinuance and process change notification. All products are sold subject to IR's terms and conditions of sale supplied at the time of order acknowledgment.

IR warrants performance of its hardware products to the specifications applicable at the time of sale in accordance with IR's standard warranty. Testing and other quality control techniques are used to the extent IR deems necessary to support this warranty. Except where mandated by government requirements, testing of all parameters of each product is not necessarily performed.

IR assumes no liability for applications assistance or customer product design. Customers are responsible for their products and applications using IR components. To minimize the risks with customer products and applications, customers should provide adequate design and operating safeguards.

Reproduction of IR information in IR data books or data sheets is permissible only if reproduction is without alteration and is accompanied by all associated warranties, conditions, limitations, and notices. Reproduction of this information with alterations is an unfair and deceptive business practice. IR is not responsible or liable for such altered documentation. Information of third parties may be subject to additional restrictions.

Resale of IR products or serviced with statements different from or beyond the parameters stated by IR for that product or service voids all express and any implied warranties for the associated IR product or service and is an unfair and deceptive business practice. IR is not responsible or liable for any such statements.

IR products are not designed, intended, or authorized for use as components in systems intended for surgical implant into the body, or in other applications intended to support or sustain life, or in any other application in which the failure of the IR product could create a situation where personal injury or death may occur. Should Buyer purchase or use IR products for any such unintended or unauthorized application, Buyer shall indemnify and hold International Rectifier and its officers, employees, subsidiaries, affiliates, and distributors harmless against all claims, costs, damages, and expenses, and reasonable attorney fees arising out of, directly or indirectly, any claim of personal injury or death associated with such unintended or unauthorized use, even if such claim alleges that IR was negligent regarding the design or manufacture of the product.

Only products certified as military grade by the Defense Logistics Agency (DLA) of the US Department of Defense, are designed and manufactured to meet DLA military specifications required by certain military, aerospace or other applications. Buyers acknowledge and agree that any use of IR products not certified by DLA as military-grade, in applications requiring military grade products, is solely at the Buyer's own risk and that they are solely responsible for compliance with all legal and regulatory requirements in connection with such use.

IR products are neither designed nor intended for use in automotive applications or environments unless the specific IR products are designated by IR as compliant with ISO/TS 16949 requirements and bear a part number including the designation "AU". Buyers acknowledge and agree that, if they use any non-designated products in automotive applications, IR will not be responsible for any failure to meet such requirements.

For technical support, please contact IR's Technical Assistance Center  
<http://www.irf.com/technical-info/>

**WORLD HEADQUARTERS:**

101 N. Sepulveda Blvd., El Segundo, California 90245  
Tel: (310) 252-7105

**Revision History**

<b>Revision</b>	<b>Date</b>	<b>Notes/Changes</b>
A1	October 2011	First release
B	March 2012	Remove the preliminary mention
C	October 18, 2012	Remove the PbF mention
D	June, 16 <sup>th</sup> 2014	Update minimum value of Ilim Remove TRR and TR packing option
E	July 17, 2014	Remove Pbf suffix in the 1 <sup>st</sup> page