

## STEP-UP OR DOWN, SINGLE-COIL, PWM CONTROL SWITCHING REGULATOR CONTROLLER

# S-8460

The S-8460 is a PWM control CMOS step-up and step-down switching regulator controller which consists of an automatic-selection control circuit for step-up and step-down, a reference voltage circuit, an oscillation circuit, an error amplifier, a phase compensation circuit, etc. The automatic-selection control circuit for step-up and step-down in PWM control realizes a high performance step-up and step-down switching regulator operating on one coil. With an external N-channel power MOS, the S-8460 is ideal for applications requiring high efficiency and a high current output.

The S-8460 realizes low ripple, high efficiency and excellent characteristics by featuring a PWM switching controller that can change the duty ratio linearly from 0%, and the optimized error amplifier and phase compensation circuit.

### ■ Features

- Single-coil, step-up or step-down switching realizes high efficiency.
- High efficiency is realized by using only N-channel power MOS FET as an external power MOS
- Synchronous rectification at step-down operation
- Input voltage : 2.2 to 18.0 V
- Variable output voltage : Output voltage range 2.5 to 6.0 V
- Automatic-recovery overload protection circuit
- Oscillation frequency : 300 kHz
- Soft-start function set by an external capacitor ( $C_{SS}$ )
- Shutdown function
- Lead-free products

### ■ Applications

- Power supplies for portable equipments such as PDAs, electronic notebooks, cellular phones.
- Main or local power supplies for notebook PCs and peripherals.
- Constant voltage power supplies for cameras, VCRs, and communication devices.
- Available from 2 dry battery cells and 1 lithium cell to AC adapter.

### ■ Package

Package Name	Drawing Code		
	Package	Tape	Reel
16-Pin TSSOP	FT016-A	FT016-A	FT016-A



■ Pin Configuration

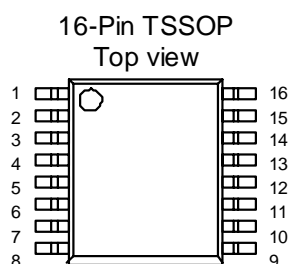

Figure 2

Table 1

Pin No.	Symbol	Pin Description
1	VIN	IC power supply pin
2	VL	Power supply pin for boost <sup>*1</sup>
3	ON/OFF	Shutdown pin "H" : Normal operation (step-up and down) "L" : Halt (no step-up and down)
4	VSS	GND pin <sup>*2</sup>
5	CSS	Capacitor connection pin for soft-start time
6	CPRO	Capacitor connection pin for setting protection time
7	T	Test pin, should be connected to GND
8	NC	No connection <sup>*3</sup>
9	FB	FB pin
10	NC	No connection <sup>*3</sup>
11	EXT3	External transistor driving pin 3
12	DVSS	Digital GND pin <sup>*2</sup>
13	EXT2	External transistor driving pin 2
14	LX	Connection pin for coil
15	EXT1	External transistor driving pin 1
16	BST	Boost capacitor connection pin for SW1 driving

\*1. No use except boosting this IC is allowed.

\*2. The VSS pin and DVSS pin are internally short-circuited.

\*3. The NC pin is electrically open. Connection of this pin to VIN or VSS is allowed.

■ Absolute Maximum Ratings

Table 2

(Ta = 25°C unless otherwise specified)

Parameter	Symbol	Absolute Maximum Rating	Unit
VIN pin voltage	V <sub>IN</sub>	V <sub>SS</sub> - 0.3 to V <sub>SS</sub> + 20	V
FB pin voltage	V <sub>FB</sub>	V <sub>SS</sub> - 0.3 to V <sub>SS</sub> + 20	V
ON/OFF pin voltage	V <sub>ON/OFF</sub>	V <sub>SS</sub> - 0.3 to V <sub>SS</sub> + 20	V
CSS pin voltage	V <sub>CSS</sub>	V <sub>SS</sub> - 0.3 to V <sub>L</sub> + 0.3	V
CPRO pin voltage	V <sub>PRO</sub>	V <sub>SS</sub> - 0.3 to V <sub>L</sub> + 0.3	V
BST pin voltage	V <sub>BST</sub>	V <sub>SS</sub> - 0.3 to V <sub>SS</sub> + 25	V
BST pin - LX pin voltage	V <sub>BST</sub> - V <sub>LX</sub>	-0.3 to +7	V
LX pin voltage	V <sub>LX</sub>	V <sub>SS</sub> - 3 to V <sub>SS</sub> + 20	V
EXT1 pin voltage	V <sub>EXT1</sub>	V <sub>LX</sub> - 0.3 to V <sub>BST</sub> + 0.3	V
EXT2, 3 pin voltage	V <sub>EXT2,3</sub>	V <sub>SS</sub> - 0.3 to V <sub>L</sub> + 0.3	V
EXT1, 2, 3 pin current	I <sub>EXT1,2,3</sub>	±100	mA
LX pin current	I <sub>LX</sub>	±100	mA
BST pin current	I <sub>BST</sub>	±100	mA
VL pin voltage <sup>*1</sup>	V <sub>L</sub>	V <sub>SS</sub> - 0.3 to V <sub>SS</sub> + 7	V
VL pin current <sup>*1</sup>	I <sub>VL</sub>	±100	mA
T pin voltage <sup>*2</sup>	V <sub>T</sub>	V <sub>SS</sub> - 0.3 to V <sub>SS</sub> + 20	V
Power dissipation	P <sub>D</sub>	400 (When not mounted on board)	mW
		1100 <sup>*3</sup>	mW
Operating ambient temperature	T <sub>opr</sub>	-40 to +85	°C
Storage temperature	T <sub>stg</sub>	-40 to +125	°C

\*1. Only capacitor C<sub>VL</sub> and Schottky diode SD2 can be connected to this pin.

\*2. The T pin should be connected to GND.

\*3. When mounted on board

[Mounted board]

(1) Board size : 114.3 mm × 76.2 mm × t1.6 mm

(2) Board name : JEDEC STANDARD51-7

**Caution** The absolute maximum ratings are rated values exceeding which the product could suffer physical damage. These values must therefore not be exceeded under any conditions.

(1) When mounted on board

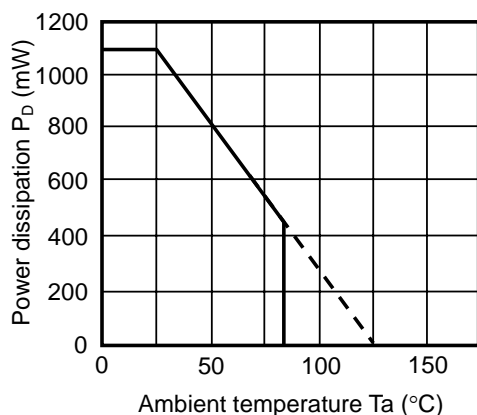

(2) When not mounted on board

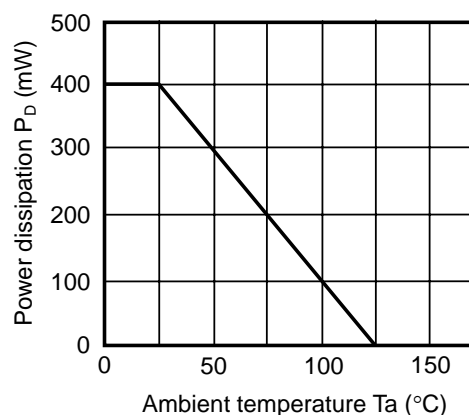

Figure 3 Power Dissipation of Packages

## ■ Electrical Characteristics

**Table 3**

(Unless otherwise specified :  $V_{IN} = 5.0\text{ V}$ ,  $I_{OUT} = 66\text{ mA}$ , output voltage is set to  $3.3\text{ V}$ ,  $T_a = 25^\circ\text{C}$ )

Parameter	Symbol	Conditions	Min.	Typ.	Max.	Unit	Measurement Circuit
Output voltage at step-down	$V_{OUTD}$	$V_{IN} = 4.95\text{ V}$	3.234	3.3	3.366	V	2
Output voltage at step-up	$V_{OUTU}$	$V_{IN} = 2.64\text{ V}$	3.234	3.3	3.366	V	2
Input voltage	$V_{IN}$	—	2.2	—	18.0	V	2
Current consumption 1	$I_{SS1}$	No external parts, $V_{OUT} = 3.3\text{ V} \times 0.95\text{ V}$ (step-up mode at MaxDuty)	—	900	1380	$\mu\text{A}$	1
Current consumption 2	$I_{SS2}$	No external parts, $V_{OUT} = 3.3\text{ V} + 0.5\text{ V}$ (step-down mode at 0% Duty)	—	75	150	$\mu\text{A}$	1
Current consumption at shutdown	$I_{SSS}$	$V_{ON/OFF} = 0\text{ V}$	—	0.5	2.0	$\mu\text{A}$	1
VL pin output voltage	$V_L$	The same condition as $I_{SS2}$	4.32	4.50	4.68	V	1
EXT1, 2, 3 pin output current	$I_{EXT1,2,3H}$	$V_L = 4.5\text{ V}$ , $V_{EXT1,2,3} = V_L - 0.2$	30	40	—	mA	1
	$I_{EXT1,2,3L}$	$V_{EXT1,2,3} = 0.2\text{ V}$	40	60	—	mA	1
Line regulation	$\Delta V_{OUT1}$	$V_{IN} = 2.2\text{ to }18.0\text{ V}$	—	$V_{OUTD} \times 1.0\%$	$V_{OUTD} \times 2.0\%$	V	2
Load regulation	$\Delta V_{OUT2}$	$I_{OUT} = 10\ \mu\text{A to }1.25 \times 66\text{ mA}$ $V_{IN} = 4.95\text{ V}$	—	$V_{OUTD} \times 1.0\%$	$V_{OUTD} \times 2.0\%$	V	2
Output voltage temperature coefficient	$\frac{\Delta V_{OUT}}{\Delta T_a \cdot V_{OUT}}$	$T_a = -40\text{ to }+85^\circ\text{C}$	—	$\pm 100$	—	ppm/ $^\circ\text{C}$	—
Oscillation frequency	$f_{OSC}$	The same condition as $I_{SS1}$ , waveform at EXT3 pin is measured.	255	300	345	kHz	1
Maximum duty ratio	MaxDuty	The same condition as $I_{SS1}$ , waveform at EXT3 pin is measured.	70	78	85	%	1
FB pin input current	$I_{FB}$	The same condition as $I_{SS1}$	—	0.0	0.1	$\mu\text{A}$	1
ON/OFF pin input voltage	$V_{SH}$	The same condition as $I_{SS2}$ , judged by voltage output at VL pin.	1.6	—	—	V	1
	$V_{SL}$	The same condition as $I_{SS2}$ , judged by voltage output at VL pin.	—	—	0.4	V	1
ON/OFF pin input leakage current	$I_{SH}$	The same condition as $I_{SS1}$ , $V_{ON/OFF} = V_{IN}$	-0.1	—	0.1	$\mu\text{A}$	1
	$I_{SL}$	The same condition as $I_{SS1}$ , $V_{ON/OFF} = 0\text{ V}$	-0.1	—	0.1	$\mu\text{A}$	1
Soft-start time	$t_{SS}$	The same condition as $I_{SS1}$ , time for EXT3 pin to start is measured.	6.0	12.0	24.0	ms	1
Integration time of protection circuit	$t_{PRO}$	The same condition as $I_{SS1}$ , CSS pin : OPEN, $C_{PRO} : 2200\text{ pF}$ , repeat time of $C_{PRO}$ pin is measured.	1.25	2.5	5.0	ms	1
Efficiency at step-down	EFFI1	$V_{IN} = 4.95\text{ V}$ , $I_{OUT} = 200\text{ to }600\text{ mA}$	—	87	—	%	2
Efficiency at step-up	EFFI2	$V_{IN} = 2.64\text{ V}$ , $I_{OUT} = 50\text{ to }400\text{ mA}$	—	83	—	%	2

External parts

Coil :	Sumida Corporation	CDRH104R (22 $\mu\text{H}$ )
Diode :	Matsushita Electric Industrial Co., Ltd.	MA2Q737 (Schottky)
	Rohm Corporation	RB411D (Schottky)
Capacitor :	Nichicon Corporation	F93 (16 V, 47 $\mu\text{F}$ , tantalum) $\times 4$
Transistor :	Fairchild Semiconductor Corporation	FDN337N $\times 3$
$C_{VL}$ :	4.7 $\mu\text{F}$ (ceramic)	
$C_{SS}$ :	4700 pF	
$C_{PRO}$ :	2200 pF	
$C_{BST}$ :	0.1 $\mu\text{F}$	
$R_{FB1}$ :	230 k $\Omega$	
$R_{FB2}$ :	100 k $\Omega$	
$C_{fzfb}$ :	330 pF	

■ Measurement Circuits

1.

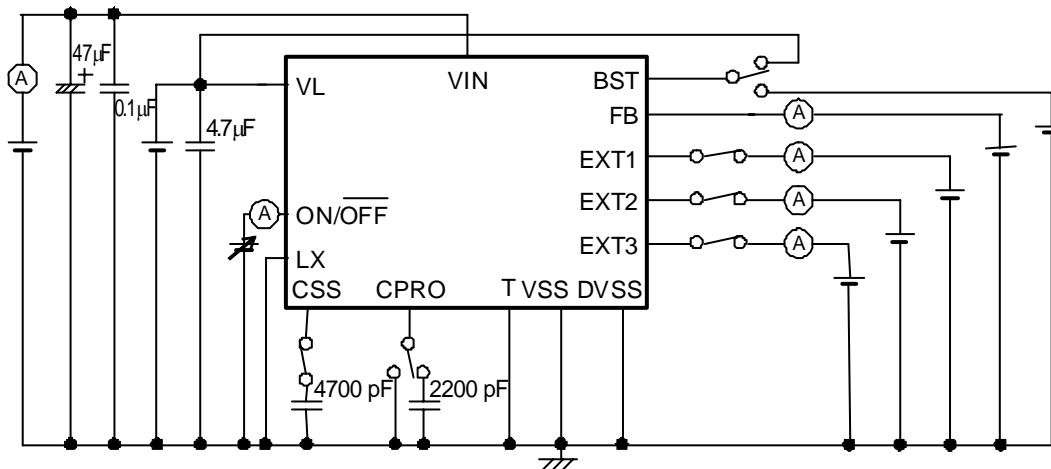

Figure 4

2.

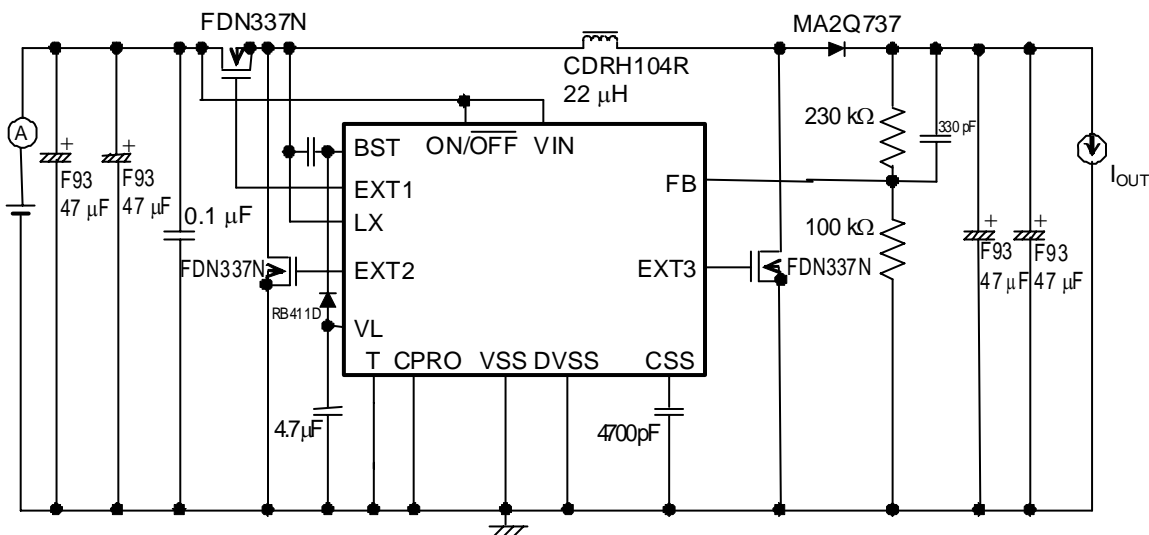

Figure 5

■ Operation

1. Step-up or Step-down DC-DC Converter

1.1 Basic Operation

The S-8460 automatically selects step-up operation or step-down operation to hold the output voltage constant according to the input voltage ( $V_{IN}$ ), output voltage ( $V_{OUT}$ ), and output current ( $I_{OUT}$ ). A high-efficient power supply can be constructed using the S-8460, since the S-8460 works as a switching regulator for both step-up and step-down operation.

Figure 6 shows the block diagram of the S-8460.

Internal circuits operate on the internal voltage ( $V_L$ ) except pre-driver circuit for EXT1 and ON/OFF circuit. When  $V_{IN}$  is 4.5 V or more, the voltage is stepped down to 4.5 V and when  $V_{IN}$  is lower than 4.5 V,  $V_L$  is set to  $V_{IN}$ . The output voltage of the pre-driver circuit for EXT1 lies between the BST pin voltage  $V_{BST}$  and the LX pin voltage  $V_{LX}$  where the BST pin voltage  $V_{BST}$  is normally  $V_{LX} + V_L$ . The gate to source voltages for all external MOS FETs, SW1 to SW3, thus become  $V_L$ , which drives these external MOS FETs.

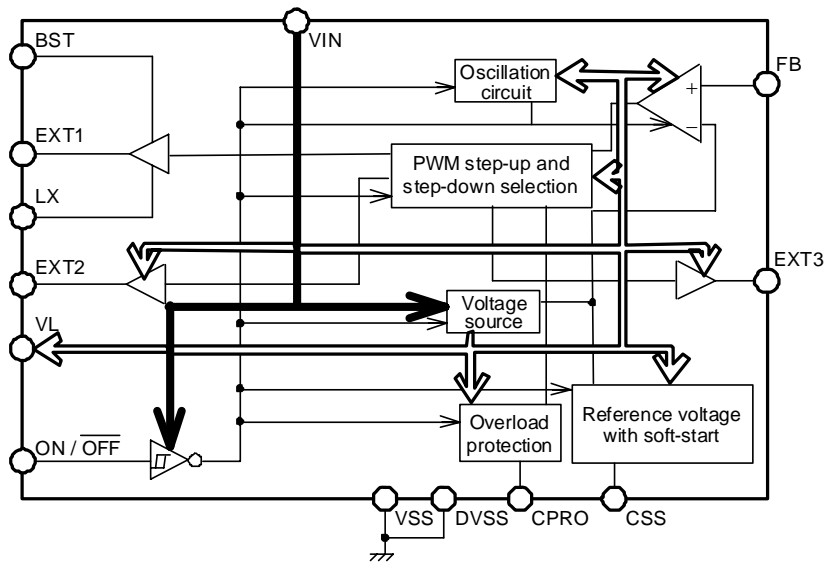
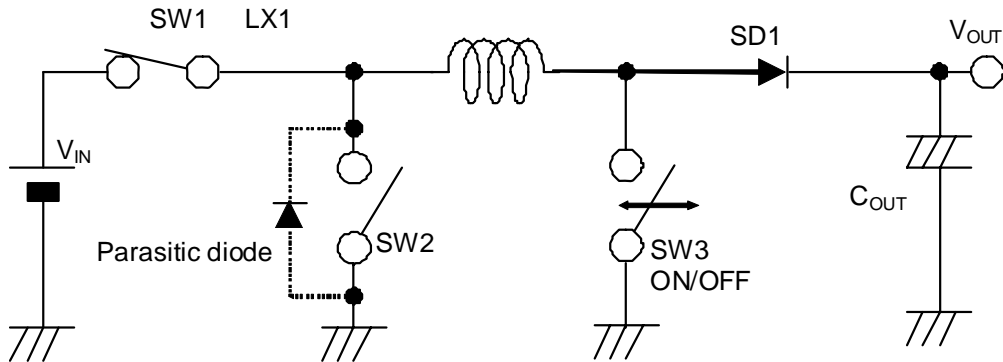

Figure 6

**1.2 Step-up Operation**

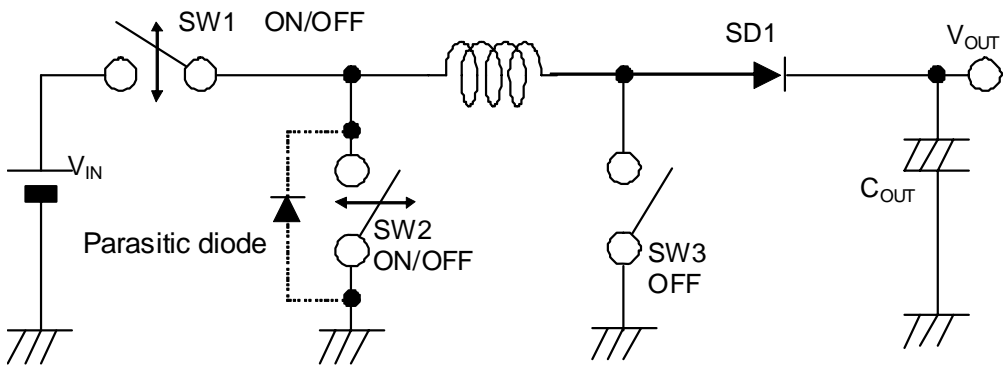

**Figure 7**

Step-up operation is carried out by setting SW1 : ON, SW2 : OFF, and toggling SW3. The voltage  $V_{IN} + V_L$  is needed at the BST pin to turn SW1 on. For this purpose, the BST pin voltage ( $C_{BST}$ ) is charged to the  $V_L$  voltage by the switch combination SW1 : OFF, SW2 : ON for approximately 200 ns just after SW3 is turned off, and the BST pin is then bootstrapped to  $V_{IN} + V_L$  by SW1 : ON, SW2 : OFF.

SW2 is turned on after SW1 is turned off and SW1 is turned on after SW2 is turned off to avoid the large current to flow between  $V_{IN}$  and  $V_{SS}$  if SW1 and SW2 are turned on simultaneously. When the two switches, SW1 and SW2, are turned off, current flows to  $V_{OUT}$  through the parasitic diode of SW2. In some MOS FETs current is not allowed to flow through the parasitic diode. In this case, a Schottky diode must be connected parallel to the MOS FET.

**1.3 Step-down Operation**



**Figure 8**

Step-down operation is carried out by synchronous switching of SW1 and SW2, and keeping SW3 open. The BST pin voltage is kept at  $V_{IN} + V_L$ , since the switches, SW1 and SW2, repeat toggling in each period in step-down operation.



1.4 Control Sequence

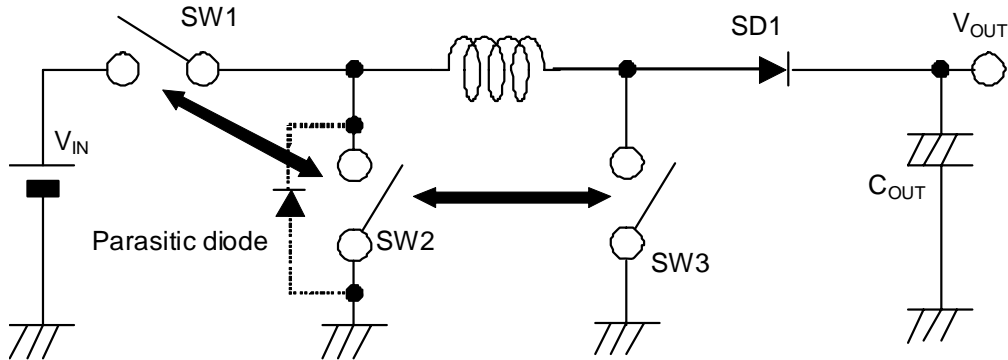

Figure 9

If the switches, SW1 and SW2, are turned on simultaneously,  $V_{IN}$  and  $V_{SS}$  are short-circuited and large useless current flows. And if the switches, SW2 and SW3, are turned on simultaneously, the energy stored in the coil flows to  $V_{SS}$  and is wasted. The S-8460 thus controls the switches in such a way that in operations involving SW1 and SW2, and involving SW2 and SW3 both switches are turned off simultaneously to avoid useless current flowing due to simultaneous turn-on of the switches.

1.5 Step-up and Step-down Selection Control

The S-8460 automatically selects operation between step-up and step-down to maintain a constant output voltage according to the relationship between the input voltage ( $V_{IN}$ ), output voltage ( $V_{OUT}$ ), and output current ( $I_{OUT}$ ). Simple relationships that step-up operation work when input voltage  $\leq$  output voltage and that step-down operation work when input voltage  $\geq$  output voltage do not hold. Step-up operation emerges when the output voltage is kept constant by step-up operation, and step-down operation emerges when the output voltage is kept constant by step-down operation according to the relationship between  $V_{IN}$ ,  $V_{OUT}$ , and  $I_{OUT}$ .

Figure 10 shows the turning point between step-up operation and step-down schematically for the case when the output voltage is 3.3 V. In the area where the two slant lines are crossing and noted by "Step-up or down" the S-8460 shows step-up operation or step-down operation. Not that step-up operation and step-down operation appear alternately in this area, but that one of the two operations is selected and stable operation is carried out. The voltage for the turning point between step-up and step-down varies slightly due to external parts and mounting conditions.

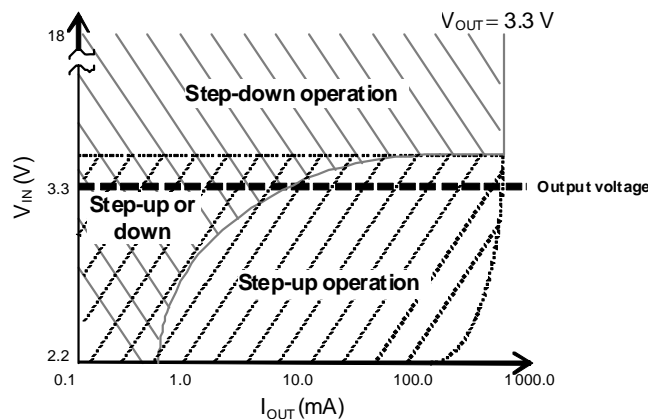

Figure 10 Graphic Scheme for Automatic Selection of Step-up and Step-down

**1.6 PWM Control**

The S-8460 is a DC-DC converter using a pulse width modulation method (PWM) and features a low current consumption. In conventional PFM DC-DC converters, pulse are skipped when the output load current is low, causing a fluctuation in the ripple frequency of the output voltage, resulting in an increase in the ripple voltage. The switching frequency does not change, although the pulse width changes from 0 to 83% at step-up operation and 0 to 78% in step-up operation. When the pulse width is 0% (when there is no load or the input voltage is high), current consumption is low since pulses are skipped.

**2. Soft-Start Function**

The S-8460 has a built-in soft-start circuit. This circuit enables the output voltage to rise gradually over the specified soft-start time to suppress the overshooting of the output voltage when the power is switched on or the ON/OFF pin is changed from “L” to “H”.

The soft-start time ( $t_{SS}$ ) can be set by an external capacitor ( $C_{SS}$ ).

The time needed for the output voltage ( $V_{OUT}$ ) to reach 95% of the setting value of the output voltage is approximately expressed by the following equation.

$$t_{SS} \text{ (ms)} = 0.0026 \times C_{SS} \text{ (pF)}$$

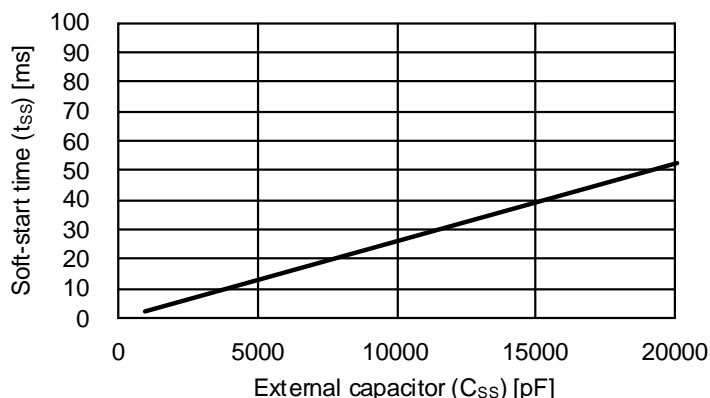

**Figure 11 Soft-Start Time**

The value for  $C_{SS}$  should be selected to give enough margin to the soft-start time against the power supply rise time. If the soft-start time is short, possibility for output overshoot, input current rush, and malfunction of the IC increases.

**3. ON/OFF Pin (Shutdown Pin)**

When the ON/OFF pin is set to “L”, the EXT1 pin voltage becomes equal to the  $L_X$  voltage and the voltage of the EXT2 and EXT3 pins becomes  $V_{SS}$  level to turn the external MOS FET off. At the same time, the S-8460 stops all the internal circuit and suppresses the current consumption down to approximately 0.5  $\mu$ A. The power supply ( $V_L$ ), the CSS pin, and CPRO pin become  $V_{SS}$  level. Electrical isolation between power input side  $V_{IN}$  and output side  $V_{OUT}$  is thus possible when the S-8460 is in halt state.

The ON/OFF pin is configured as shown in **Figure 12** and is not either pulled up or pulled down. So, do not use it with it in a floating state. When the ON/OFF pin is not used, connect it to the VIN pin.

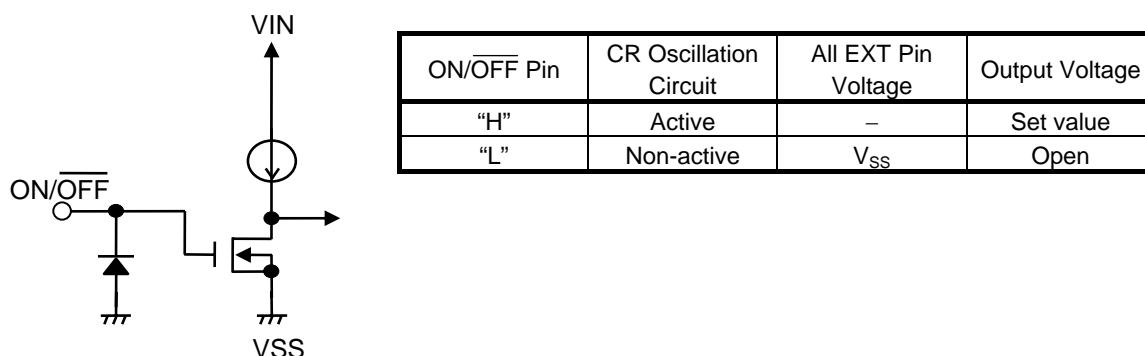

Figure 12 ON/OFF Pin Structure

#### 4. Overload Protection Circuit

The S-8460 contains a built-in overload protection circuit.

When the output voltage falls because of an overload despite the step-up operation or step-down, the S-8460 enters the step-up operation and holds the maximum duty step-up operation. If this maximum duty state lasts longer than the overload detection time ( $t_{PRO}$ ), the overload protection circuit will hold the pins EXT1 to EXT3 at “L” to protect the switching transistors and the inductor. When the overload protection circuit works, the output voltage ( $V_{OUT}$ ) rises slowly since a soft start is carried out in the reference voltage circuit in the IC to raise the reference voltage slowly from 0 V. If the load is still heavy at this time and the maximum duty step-up operation lasts longer than  $t_{PRO}$ , the overload protection circuit will work again. Repeat of this process leads to an operation of intermittent mode. If the overload state is eliminated, the S-8460 goes back to the normal operation.

$t_{PRO}$  is determined by the external capacitor ( $C_{PRO}$ ). The approximate value of  $t_{PRO}$ , which is from the beginning of the maximum duty operation to the instant at which pin voltage of the EXT1 to EXT3 is held “L” to protect switching transistors, is expressed by the following equation.

$$t_{PRO} [ms] = 0.0011 \times C_{PRO} [pF]$$

### External Parts Selection

#### 1. Inductor

The inductance value (L value) greatly affects the maximum output current ( $I_{OUT}$ ) and the efficiency ( $\eta$ ).

As the L value is reduced gradually, the peak current ( $I_{PK}$ ) increases, the stability of the circuit is improved, and the output current  $I_{OUT}$  increases. As the L value is made even smaller,  $I_{OUT}$  decreases since the current driveability of the switching transistor is insufficient.

As the L value is increased, the dissipation in the switching transistor due to  $I_{PK}$  decreases, and the efficiency reaches the maximum at a certain L value. As the L value is made even larger, the efficiency degrades since the dissipation due to the series resistance of the coil increases.  $I_{OUT}$  also decreases.

An inductance of 22  $\mu$ H is recommended for the S-8460.

When choosing an inductor, attention to its allowable current should be paid since the current exceeding the allowable value will cause magnetic saturation in the inductor, leading to a marked decline in efficiency and breakdown of the IC due to large current.

An inductor should therefore be selected so as not the peak current  $I_{PK}$  to surpass its allowable current.  $I_{PK}$  is represented by the following equations in step-up operation and in step-down operation. Comparing each calculation result for step-up and step-down, larger value should be taken as the  $I_{PK}$ . Adding some margin to the obtained result, an inductor with the allowable current can be thus chosen.

Continuous mode at step-up operation

$$I_{PK} = \frac{V_{OUT} + V_F}{V_{IN}} \times I_{OUT} + \frac{(V_{OUT} + V_F - V_{IN}) \times V_{IN}}{2 \times (V_{OUT} + V_F) \times f_{OSC} \times L}$$

Continuous mode at step-down operation

$$I_{PK} = I_{OUT} + \frac{V_{OUT} \times (V_{IN} - V_{OUT})}{2 \times f_{OSC} \times L \times V_{IN}}$$

Where  $f_{OSC}$  (= 300 kHz) is the oscillation frequency,  $L$  is the inductance value of the coil, and  $V_F$  is the diode forward voltage.  $V_F$  should be approximately 0.4 V.

## 2. Diode

Use an external diode that meets the following requirements :

- Low forward voltage (Schottky barrier diode is recommended.)
- High switching speed (50 ns)
- The current rating is larger than  $I_{PK}$ .
- The reverse-direction withstand voltage is higher than  $V_{IN}$  or  $V_{OUT}$  for SD1.
- The reverse-direction withstand voltage is higher than  $V_{IN}$  for SD2.

## 3. Capacitors

### 3.1 Input and Output Capacitors ( $C_{IN}$ , $C_{OUT}$ )

A capacitor inserted on the input side ( $C_{IN}$ ) improves the efficiency by reducing the power impedance and stabilizing the input current. Select a  $C_{IN}$  value according to the impedance of the power supply used. Select a capacitor that has low ESR (Equivalent Series Resistance) and large capacitance. Approximately 47 to 100  $\mu$ F is recommended for a capacitance depending on the impedance of the power source and load current value.

For the output side capacitor ( $C_{OUT}$ ), select a large capacitance with low ESR for smoothing the ripple voltage. When the input voltage is extremely high or the load current is extremely large, the output voltage may become unstable. In this case the unstable area will become narrow by selecting a large capacitance for an output capacitor. A tantalum electrolyte capacitor is recommended since the unstable area widens when a capacitor with a large ESR, such as an aluminum electrolyte capacitor, or a capacitor with a small ESR, such as a ceramic capacitor, is chosen.

Fully evaluate input and output capacitors under the actual operating conditions to determine the best value.

### 3.2 Internal Power Source Stabilization Capacitor ( $C_{VL}$ )

The main circuits of the IC work on an internal power source connected to the VL pin.  $C_{VL}$  is a bypass capacitor for stabilizing the internal power source.  $C_{VL}$  is a 4.7  $\mu$ F ceramic capacitor and it should be wired nearby and at a low impedance.

## 4. External Transistors

Enhancement N-channel MOS FETs should be used for the external transistors.

SW1 is driven by the bootstrapped voltage. If a bipolar transistor is used for SW1, SW1 is not turned on since the charge in the capacitor ( $C_{BST}$ ) for bootstrap is discharged.

#### 4.1 Enhancement (N-channel) MOS FET

The EXT1 to EXT3 pins can directly drive an N-channel MOS FET with a gate capacitance of approximate 1000 pF.

When an N-channel MOS FET is used, efficiency will be 2 to 3% higher than that achieved by a PNP or an NPN bipolar transistor since the MOS FET switching speed is faster than that of the bipolar transistor and power dissipation due to the base current is avoided.

The important parameters in selecting a MOS FET are threshold voltage, breakdown voltage between gate and source, breakdown voltage between drain and source, total gate capacitance, on-resistance, and the current rating. Voltage swing of the EXT2 and EXT3 pins is between  $V_L$  and  $V_{SS}$ . The EXT1 pin voltage swings between  $V_{IN} + V_L$  and  $V_{IN}$  since the LX pin voltage becomes the input voltage ( $V_{IN}$ ) when SW2 is off. The breakdown voltage between the gate and source of the transistors should be at least some volts higher than the  $V_L$  voltage since the maximum voltage applied between gate and source of each MOS FET is  $V_L$ .

When  $V_{IN}$  is lower than 4.5 V, the threshold voltage of MOS FETs should be low enough to turn on completely at low input voltage since the  $V_L$  voltage becomes  $V_{IN}$ . Immediately after the power is turned on, or the shutdown state at which the step-up and step-down operation is terminated, the input voltage or output voltage is applied across the drain and the source of the MOS FETs. The transistors therefore need to have drain to source breakdown voltage that is also several volts higher than the input voltage or output voltage.

The total gate capacitance and the on-resistance affect the efficiency.

The larger the total gate capacitance becomes and the higher the input voltage becomes, the more the power dissipation for charging and discharging the gate capacitance by switching operation increases, and affects the efficiency at low load current region. If the efficiency at low load is important, select MOS FETs with a small total gate capacitance.

In regions where the load current is high, the efficiency is affected by power dissipation caused by the on-resistance of the MOS FETs.

If the efficiency under heavy load is particularly important in the application, choose MOS FETs having on-resistance as low as possible.

As for the current rating, select a MOS FET whose maximum continuous drain current rating is higher than the  $I_{PK}$ .

If the external MOS FETs have much different characteristics (input capacitance, threshold value, etc.) among them, they turn on at the same time to let a through current flow and reduce efficiency. If a MOS FET with a large input capacitance is used, switching dissipation increases and efficiency decreases. If such a MOS FET is used at several hundreds of mA or more, the dissipation at the MOS FET increases and may exceed the power dissipation of the MOS FET. In selecting MOS FETs, thorough evaluation under the actual condition is indispensable.

For reference, efficiency data using Sanyo CPH6401, CPH3403, and FTS2001, Vishay Siliconix Si2302DS, and Fairchild Semiconductor FDN335N is attached in this document. Refer to "■ Reference Data".

In some MOS FETs current flow through the parasitic diode is not allowed. In this case, a Schottky diode must be connected in parallel to the MOS FET. The Schottky diode must have a low forward voltage, a high switching speed, a reverse-direction withstand voltage higher than the input/output voltage, and a current rating higher than  $I_{PK}$ .

**5. Output Voltage Adjustment**

The output voltage is externally set in the S-8460. The output voltage can be set and adjusted in the output voltage setting range (2.5 to 6.0 V) by adding external resistors ( $R_{FB1}$  and  $R_{FB2}$ ) and a capacitor ( $C_{fzfb}$ ).

Temperature gradient can be added by inserting a thermistor in series to  $R_{FB1}$  and  $R_{FB2}$ .

The output voltage is set as  $(R_{FB1} + R_{FB2})/R_{FB2}$ , since the FB pin voltage is kept 1.0 V.  $R_{FB1} + R_{FB2}$  must not exceed 2 M $\Omega$ . A capacitor  $C_{fzfb}$  should be added in parallel to the external resistor  $R_{FB1}$  to avoid unstable operation like output oscillation.

Set the  $C_{fzfb}$  so that  $f = 1/(2 \times \pi \times C_{fzfb} \times R_{FB1})$  is equal to 2 kHz.

Example : When  $V_{OUT} = 3.3$  V,  $R_{FB1} = 230$  k $\Omega$ ,  $R_{FB2} = 100$  k $\Omega$ , then  $C_{fzfb} = 330$  pF is recommended.

The precision of  $V_{OUT}$  determined by the resistors  $R_{FB1}$  and  $R_{FB2}$  is affected by the precision of the voltage at the FB pin (1.0 V  $\pm$ 2.0%) as well as the precision of external resistors  $R_{FB1}$  and  $R_{FB2}$ , and IC power supply voltage  $V_{IN}$ .

Waste current flows through  $R_{FB1}$  and  $R_{FB2}$ . When it is not a negligible value with respect to load current in actual use, the efficiency decreases. The values of  $R_{FB1}$  and  $R_{FB2}$  must therefore be made large.

When the  $R_{FB1}$  and  $R_{FB2}$  values are high, 1 M $\Omega$  or higher, evaluation of the influence of the noise is needed in the actual condition since the resistors become susceptible to external noise.

**Standard Circuit**

● MOS FETs Are Used

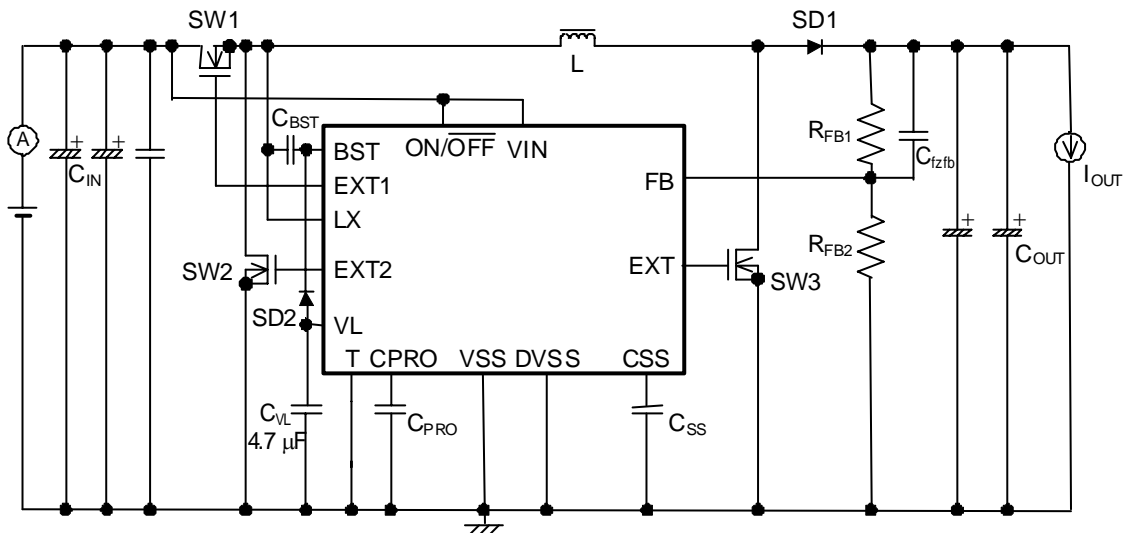

**Caution** The above connections and values will not guarantee correct operation. Before setting these values, perform sufficient evaluation on the application to be actually used.

Figure 13

## ■ Precautions

- Mount the external capacitors, diode, coil, and other peripheral parts as close to the IC as possible, and make a one-point grounding.
- Normally SW1 and SW2 do not turn on at the same time. If external N-channel transistors have much different characteristics (input capacitance,  $V_{th}$ , etc.) among them, however, they may turn on at the same time, and through current flows. Select transistors with similar characteristics.
- Characteristics ripple voltage and spike noise occur in IC containing switching regulators. Moreover rush current flows at the time of a power supply injection. Because these largely depend on the coil, the capacitor and impedance of power supply used, fully check them using an actually mounted model.
- When the input voltage is high and the output current is low, pulses with a low duty ratio may appear, and then the 0% duty ratio continues for several clocks. In this case the operation changes to the pseudo pulse frequency modulation (PFM) mode, but the ripple voltage hardly increases.
- According to the input voltage and the load condition the oscillation frequency of the EXT1 to EXT3 may become an integer fraction of 300 kHz.
- No parts other than a capacitor ( $C_{VL}$ ) and a Schottky diode (SD2) can be connected to the VL pin.
- A 4.7  $\mu$ F ceramic capacitor should be connected to the VL pin.
- The overload protection circuit of the IC starts working by detecting the time for maximum duty. In choosing the parts, make sure that the overcurrent caused by load short-circuiting will not exceed the power dissipation of the switching transistors, diodes, and the inductor.
- The oscillation frequency of the EXT1 and EXT2 may vary in some voltage range and load condition depending on input voltage.
- If the VOUT pin is short-circuited to VSS, the protection circuit starts to operate before the integral protection time  $t_{PRO}$  passes.
- When the temperature is high and the load is 0 to 1  $\mu$ A, the voltage of the EXT1 to EXT3 pins is held "L" and the output voltage  $V_{OUT}$  increases. The operation returns to normal when the load of 1  $\mu$ A or more is attached.
- Make sure that dissipation of the switching transistor especially at high temperature will not surpass the power dissipation of the package.
- Switching regulator performance varies depending on the design of PCB patterns, peripheral circuits and parts. Thoroughly evaluate the actual device when setting. When using parts other than those which are recommended, contact the SII marketing department.
- Do not apply an electrostatic discharge to this IC that exceeds the performance ratings of the built-in electrostatic protection circuit.
- SII claims no responsibility for any disputes arising out of or in connection with any infringement by products including this IC of patents owned by a third party.

■ Characteristics (Typical Data)

1. Examples of Major Characteristics

(1) Current Consumption 2 ( $I_{SS2}$ ) vs. Input Voltage ( $V_{IN}$ ) (2) Current Consumption 1 ( $I_{SS1}$ ) vs. Input Voltage ( $V_{IN}$ )

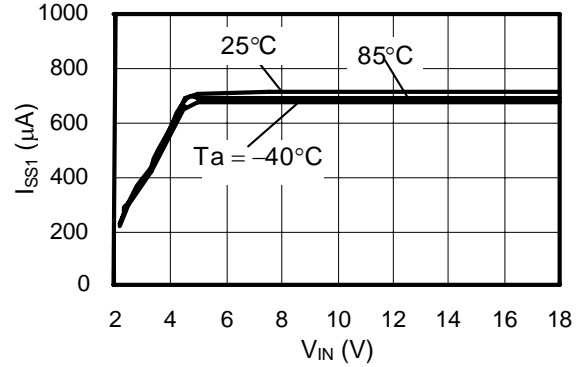
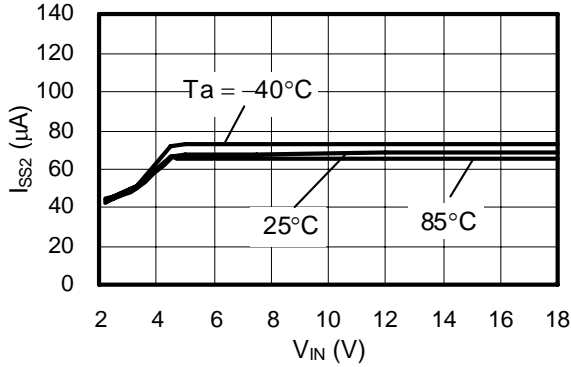

(3) Current Consumption at Shutdown ( $I_{SSS}$ ) vs. Input Voltage ( $V_{IN}$ )

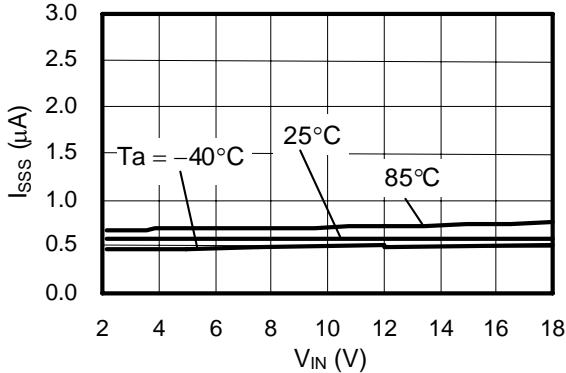

(4) VL Pin Output Voltage ( $V_L$ ) vs. Input Voltage ( $V_{IN}$ )

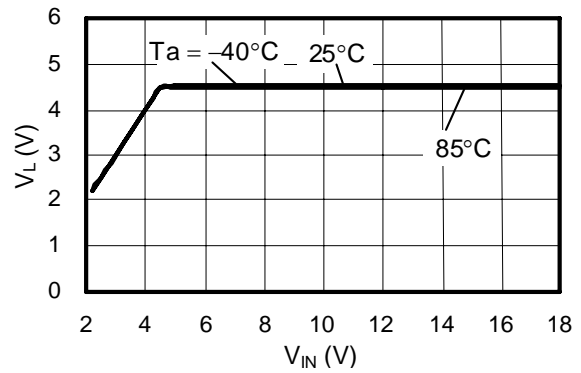

(5) ON/OFF Pin Input Voltage "H" ( $V_{SH}$ ) vs. Input Voltage ( $V_{IN}$ )

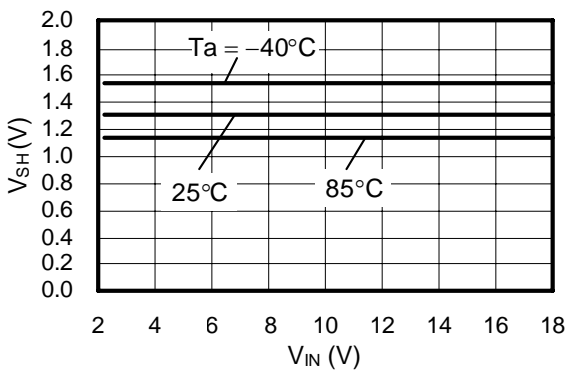

(6) ON/OFF Pin Input Voltage "L" ( $V_{SL}$ ) vs. Input Voltage ( $V_{IN}$ )

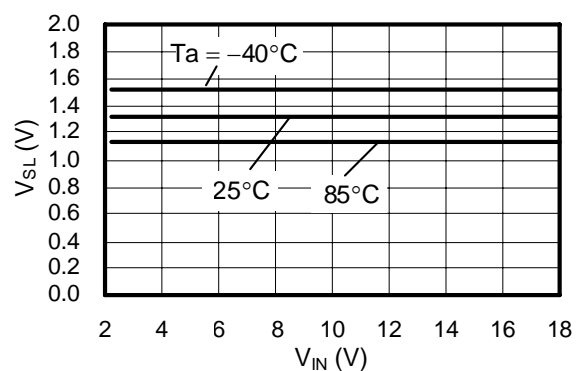

(7) Oscillation Frequency ( $f_{osc}$ ) vs. Input Voltage ( $V_{IN}$ )

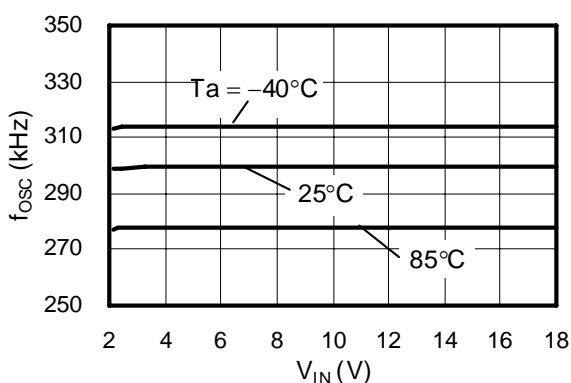

(8) Maximum Duty Ratio (MaxDuty) vs. Input Voltage ( $V_{IN}$ )

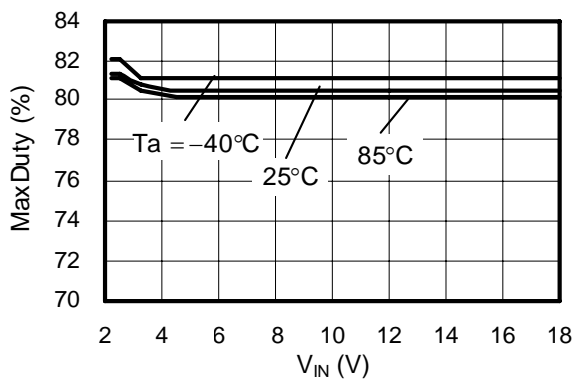



(9) EXT1 Pin Output Current "H" ( $I_{EXT1H}$ ) vs. Input Voltage ( $V_{IN}$ )

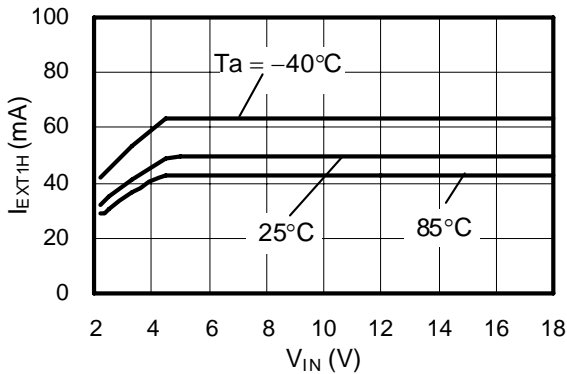

(10) EXT1 Pin Output Current "L" ( $I_{EXT1L}$ ) vs. Input Voltage ( $V_{IN}$ )

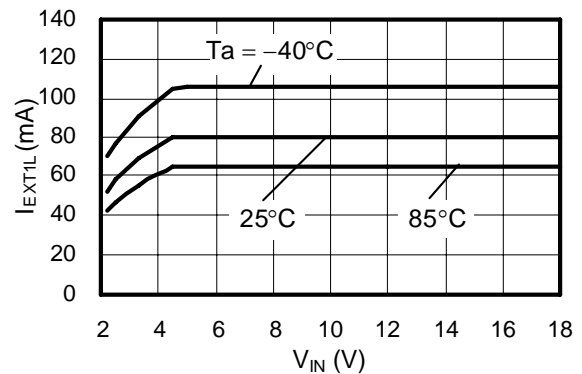

(11) EXT2 Pin Output Current "H" ( $I_{EXT2H}$ ) vs. Input Voltage ( $V_{IN}$ )

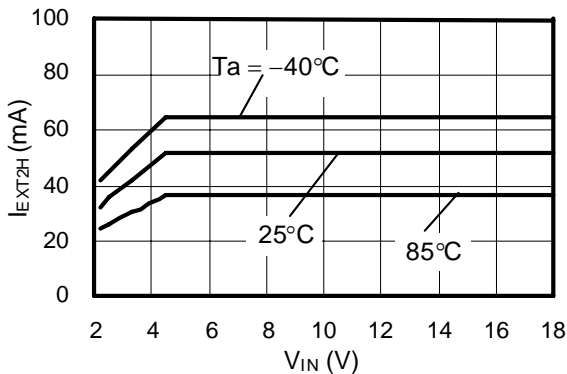

(12) EXT2 Pin Output Current "L" ( $I_{EXT2L}$ ) vs. Input Voltage ( $V_{IN}$ )

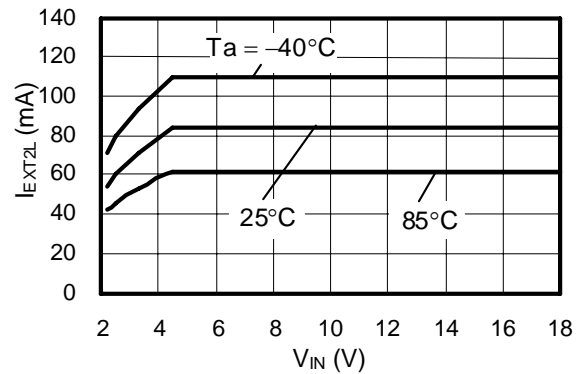

(13) EXT3 Pin Output Current "H" ( $I_{EXT3H}$ ) vs. Input Voltage ( $V_{IN}$ )

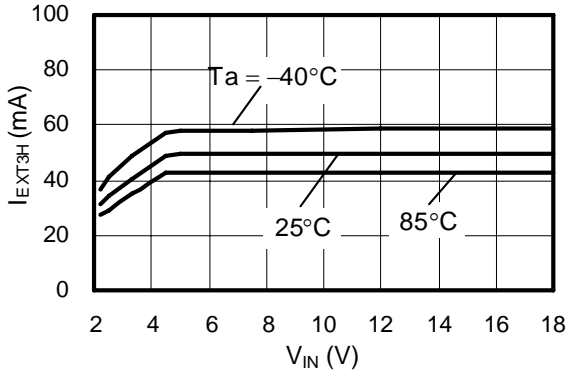

(14) EXT3 Pin Output Current "L" ( $I_{EXT3L}$ ) vs. Input Voltage ( $V_{IN}$ )

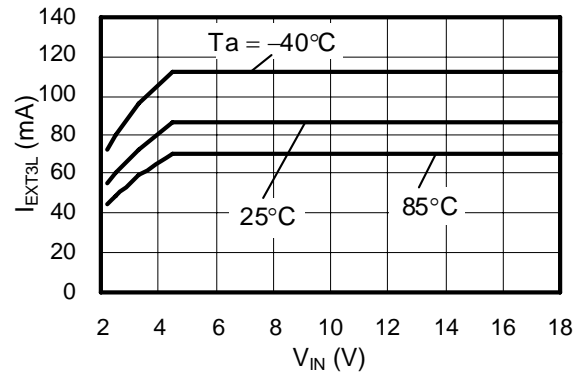

(15) Soft-Start Time ( $t_{SS}$ ) vs. Input Voltage ( $V_{IN}$ )

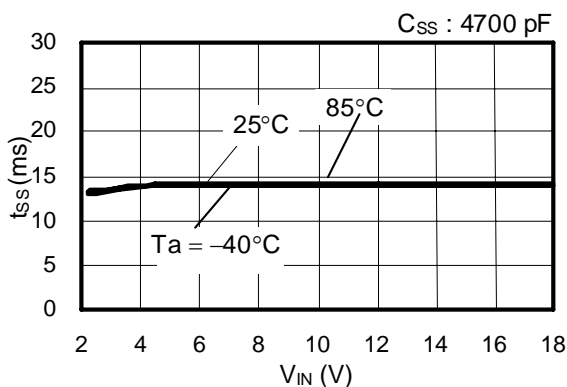

(16) Integration Time of Protection Circuit ( $t_{PRO}$ ) vs. Input Voltage ( $V_{IN}$ )

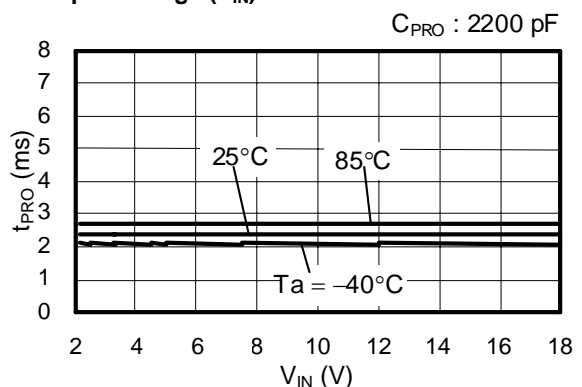

**2. Examples of Transient Response Characteristics**

**(1) Power-on ( $V_{IN} : 0\text{ V} \rightarrow 2.64\text{ V}$  or  $4.95\text{ V}$  or  $18.0\text{ V}$ ,  $I_{OUT} : \text{no load}$ ,  $V_{OUT} : 3.3\text{ V}$ ,  $C_{SS} : 4700\text{ pF}$ )**

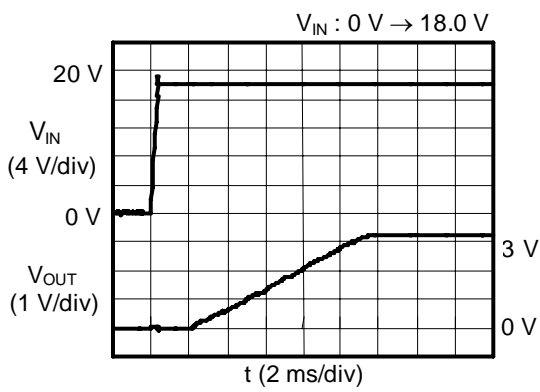
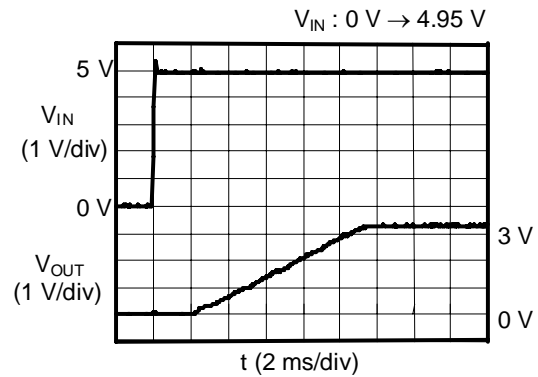
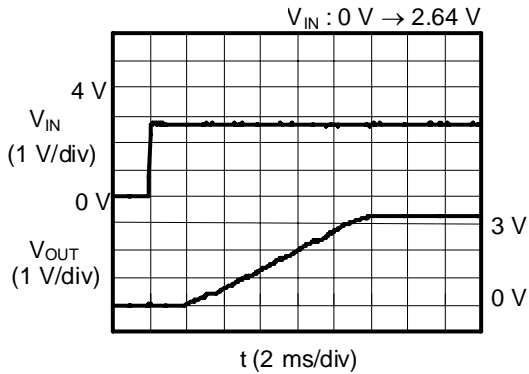

**(2) ON/OFF Pin Response ( $V_{ON/OFF} : 0\text{ V} \rightarrow 2.2\text{ V}$ ,  $I_{OUT} : \text{no load}$ ,  $V_{OUT} : 3.3\text{ V}$ ,  $C_{SS} : 4700\text{ pF}$ )**

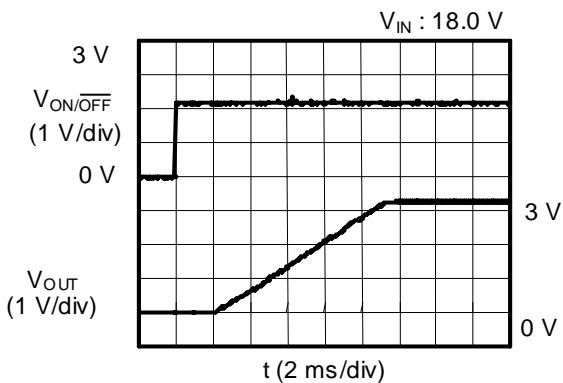
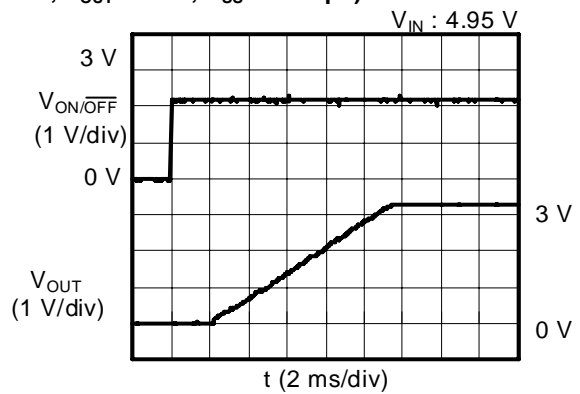
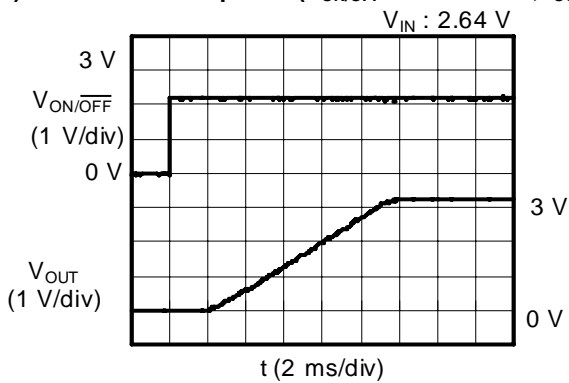

(3) Load Fluctuations ( $I_{OUT} : 10 \mu A \rightarrow 100 \text{ mA}, 100 \text{ mA} \rightarrow 10 \mu A, V_{IN} : 2.64 \text{ V}, 4.95 \text{ V}, 18.0 \text{ V}, V_{OUT} : 3.3 \text{ V}$ )

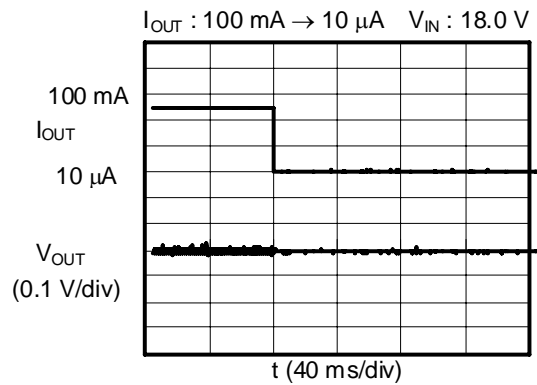
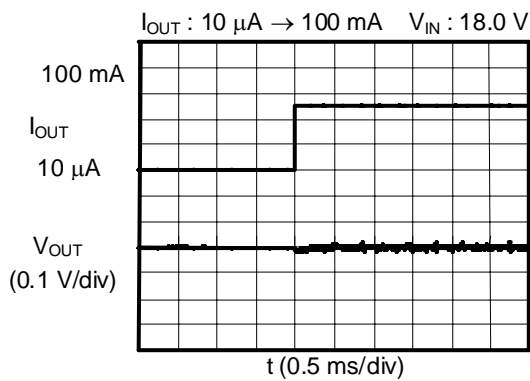
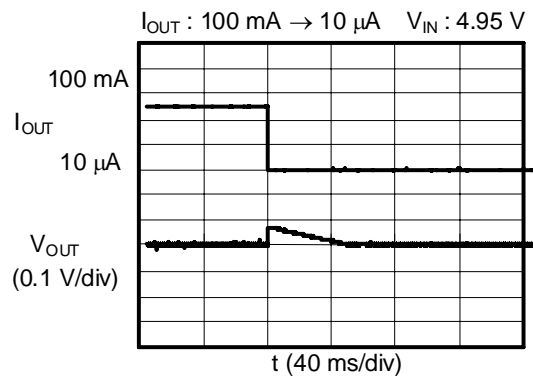
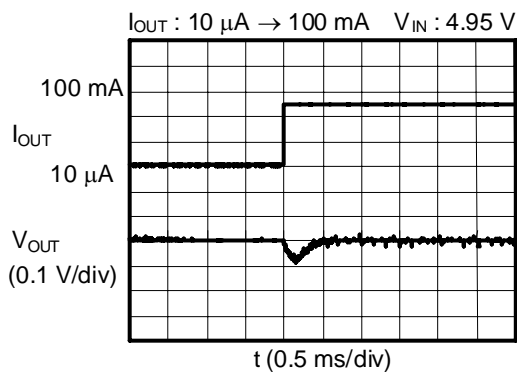
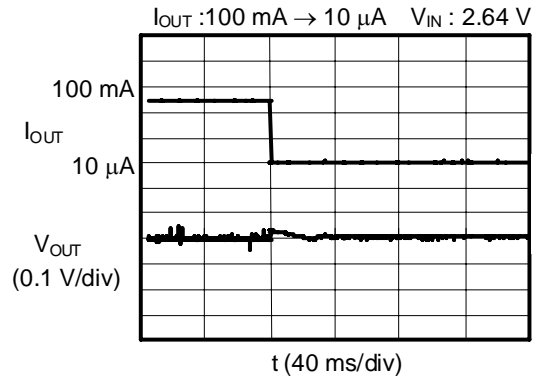
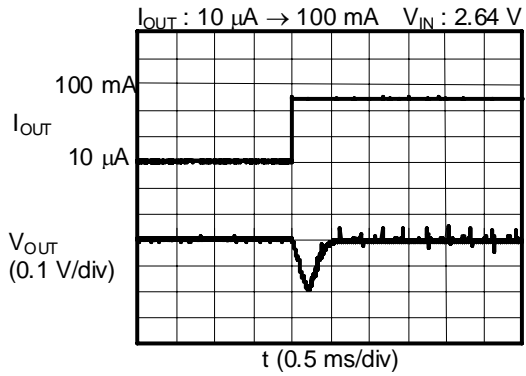

**(4) Input Voltage Fluctuation ( $V_{IN} : 2.7\text{ V} \rightarrow 5.0\text{ V}, 5.0\text{ V} \rightarrow 2.7\text{ V}, 2.2\text{ V} \rightarrow 18.0\text{ V} \rightarrow 2.2\text{ V}, I_{OUT} : 100\text{ mA}, V_{OUT} : 3.3\text{ V}$ )**

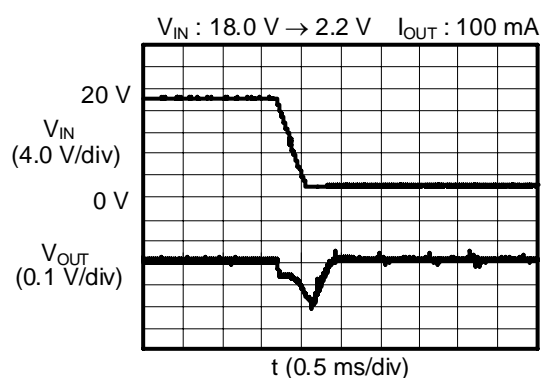
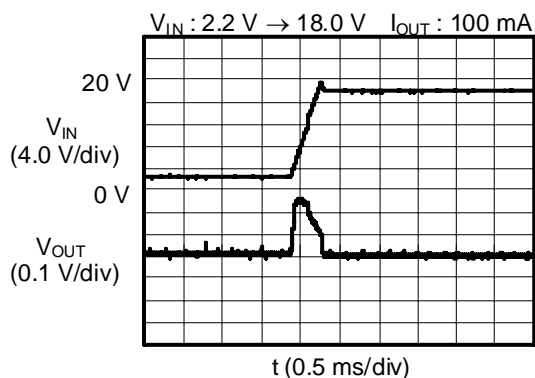
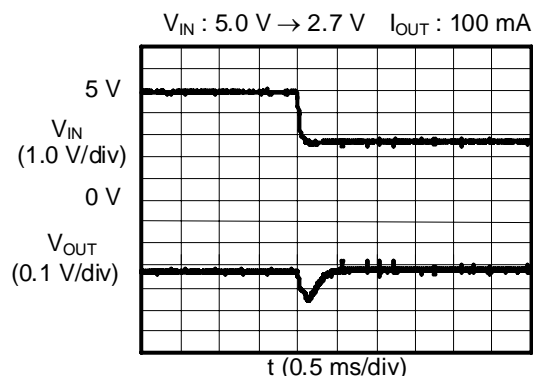
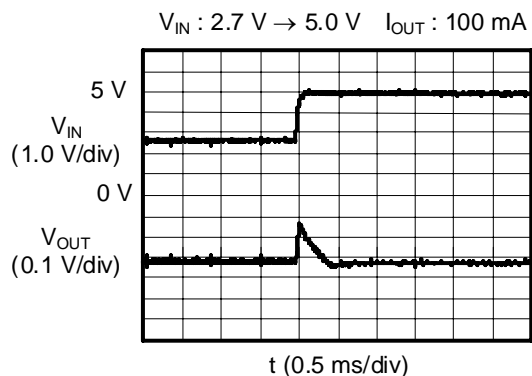

■ Reference Data

Reference data are intended for use in selecting peripheral parts to the IC. The information therefore provides characteristic data in which external parts are selected with a view of wide variety of IC applications. All data shows typical value.

1. External Parts for Reference Data

**Table 4 External Parts List for Output Current vs. Efficiency, Input Voltage vs. Efficiency, Output Current vs. Output Voltage, and Input Voltage vs. Output Voltage Characteristics**

No.	Product Name	Output Voltage	Inductor	Transistor	Diode SD1	Output Capacitor	Input Capacitor		
(1)	S-8460B00AFT	3.3 V <sup>*1</sup>	CDRH104R/22 μH	CPH6401	MA2Q737	47 μF × 2	47 μF × 2, 0.1 μF		
(2)				FTS2001					
(3)				CPH3403					
(4)				D1FH3					
(5)								Si2302DS	
(6)								FDN335N	
(7)		CDRH104R/10 μH	CPH6401	MA2Q737					
(8)		CDRH104R/47 μH							
(9)		2.5 V <sup>*2</sup>	CDRH104R/22 μH						
(10)				CPH3403	D1FH3				
(11)				CDRH104R/10 μH	CPH6401	MA2Q737			
(12)				CDRH104R/47 μH					
(13)		5.0 V <sup>*3</sup>	CDRH104R/22 μH						
(14)				CPH3403	D1FH3				
(15)				CDRH104R/10 μH	CPH6401	MA2Q737			
(16)				CDRH104R/47 μH					
(17)		3.3 V <sup>*1</sup>	CDRH104R/22 μH						
(18)				FTS2001					
(19)				CPH3403	D1FH3				
(20)				Si2302DS					
(21)				FDN335N					
(22)				CDRH104R/10 μH	CPH6401	MA2Q737			
(23)				CDRH104R/47 μH					
(24)				CDRH104R/22 μH					
(25), (28)				2.5 V <sup>*2</sup>	CDRH104R/22 μH				
(26), (29)									
(27), (30)		5.0 V <sup>*3</sup>	CDRH104R/22 μH						

\*1. External parts : R<sub>FB1</sub> = 230 kΩ, R<sub>FB2</sub> = 100 kΩ, C<sub>tfb</sub> = 330 pF

\*2. External parts : R<sub>FB1</sub> = 150 kΩ, R<sub>FB2</sub> = 100 kΩ, C<sub>tfb</sub> = 470 pF

\*3. External parts : R<sub>FB1</sub> = 400 kΩ, R<sub>FB2</sub> = 100 kΩ, C<sub>tfb</sub> = 220 pF

Measurement Circuit

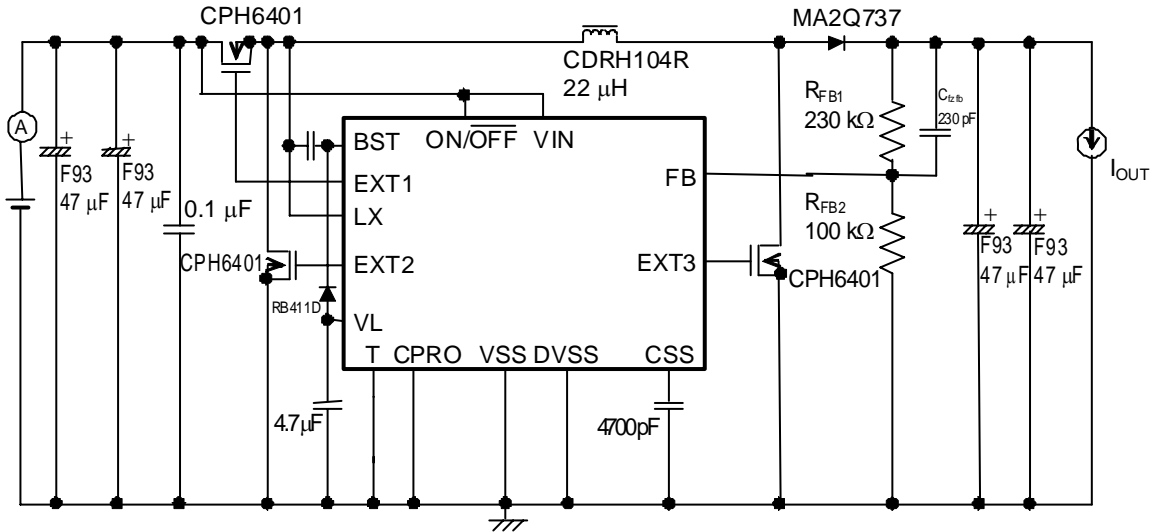

Remark Values for  $R_{FB1}$ ,  $R_{FB2}$ , and  $C_{fzfb}$  differ according to the output.

Figure 14

External Parts List for Ripple Data

Table 5 External Parts for Input Voltage vs. Ripple Voltage Characteristics Data

No.	Product Name	Output Voltage	Inductor	Transistor	Diode SD1	Output Capacitor	Input Capacitor
(31)	S-8460B00AFT	3.3 V <sup>*1</sup>	CDRH104R/22 μH	CPH6401	MA2Q737	47 μF × 2	47 μF × 2, 0.1 μF
(32)			CDRH104R/10 μH				
(33)			CDRH104R/47 μH				
(34)		2.5 V <sup>*2</sup>	CDRH104R/22 μH				
(35)		5.0 V <sup>*3</sup>	CDRH104R/22 μH				

\*1. External parts :  $R_{FB1} = 230 \text{ k}\Omega$ ,  $R_{FB2} = 100 \text{ k}\Omega$ ,  $C_{fzfb} = 330 \text{ pF}$

\*2. External parts :  $R_{FB1} = 150 \text{ k}\Omega$ ,  $R_{FB2} = 100 \text{ k}\Omega$ ,  $C_{fzfb} = 470 \text{ pF}$

\*3. External parts :  $R_{FB1} = 400 \text{ k}\Omega$ ,  $R_{FB2} = 100 \text{ k}\Omega$ ,  $C_{fzfb} = 220 \text{ pF}$

**Performance Data for Parts**

The following shows the performance of external parts.

**Table 6 Performance of External Parts**

Part	Product Name	Manufacturer	Performance				
			L	DC resist.	Max. current	Diameter	Height
Inductor	CDRH104R	Sumida Corporation	47 $\mu$ H	0.095 $\Omega$	2.1 A	13.5 mm max.	4.0 mm max.
			22 $\mu$ H	0.054 $\Omega$	2.9 A		
			10 $\mu$ H	0.026 $\Omega$	4.4 A		
Diode	MA2Q737	Matsushita Electric Industrial Co., Ltd.	Forward current 2.0 A @ $V_F = 0.5$ V				
	D1FH3	Shindengen Electric Manufacturing Co., Ltd.	Forward current 1.0 A @ $V_F = 0.3$ V				
Output Capacity	F93	Nichicon Corporation	16 V, 47 $\mu$ F				
External Transistor (N-channel FET)	CPH6401	Sanyo Electric Co., Ltd.	$V_{GS} = 12$ V max., $I_D = 4$ A max., $V_{th} = 0.4$ V min., $C_{iss} = 300$ pF typ., $R_{DS(ON)} = 0.105$ $\Omega$ max. ( $V_{GS} = 2.5$ V), CPH6 package				
	CPH3403		$V_{GS} = 12$ V max., $I_D = 2.2$ A max., $V_{th} = 0.4$ V min., $C_{iss} = 170$ pF typ., $R_{DS(ON)} = 0.220$ $\Omega$ max. ( $V_{GS} = 2.5$ V), CPH3 package				
	FTS2001		$V_{GS} = 10$ V max., $I_D = 5$ A max., $V_{th} = 0.4$ V min., $C_{iss} = 750$ pF typ., $R_{DS(ON)} = 0.046$ $\Omega$ max. ( $V_{GS} = 2.5$ V), 8-Pin TSSOP package				
	Si2302DS	Vishay Siliconix	$V_{GS} = 8$ V max., $I_D = 2.8$ A max., $V_{th} = 0.65$ V min., $R_{DS(ON)} = 0.115$ $\Omega$ max. ( $V_{GS} = 2.5$ V), SOT-23 package				
	FDN335N	Fairchild Semiconductor Corporation	$V_{GS} = 8$ V max., $I_D = 1.7$ A max., $V_{th} = 0.4$ V min., $C_{iss} = 310$ pF typ., $R_{DS(ON)} = 0.100$ $\Omega$ max. ( $V_{GS} = 2.5$ V), Super SOT-3 <sup>®</sup> package				

**Caution** The value of each characteristic in Table 6 depends on the materials prepared by each manufacturer, however, confirm the specifications by referring to respective materials when using any of the above.

**Remark** Super SOT-3 is a registered trademark or a trademark of Fairchild Semiconductor Corporation.

2. Output Current ( $I_{OUT}$ ) vs. Efficiency ( $\eta$ ) Characteristics

The following shows the actual output current  $I_{OUT}$  vs. efficiency ( $\eta$ ) characteristics when the S-8460 is used under conditions (1) to (16) in Table 4.

(1) S-8460B00AFT ( $V_{OUT} = 3.3\text{ V}$ )

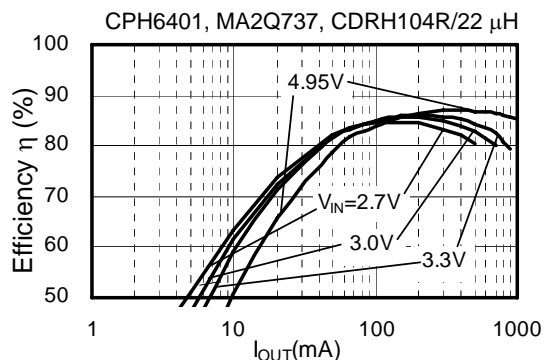

(2) S-8460B00AFT ( $V_{OUT} = 3.3\text{ V}$ )

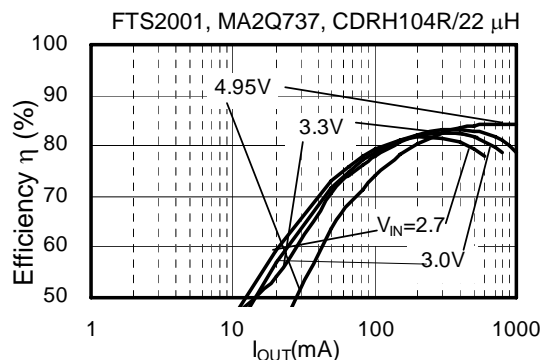

(3) S-8460B00AFT ( $V_{OUT} = 3.3\text{ V}$ )

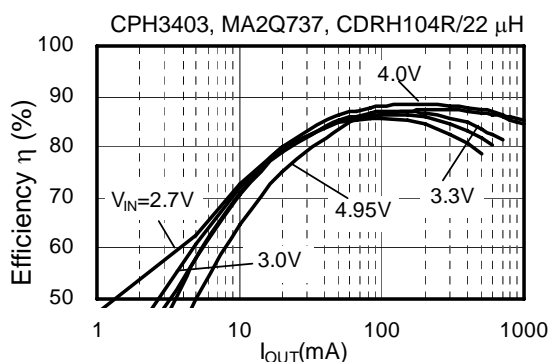

(4) S-8460B00AFT ( $V_{OUT} = 3.3\text{ V}$ )

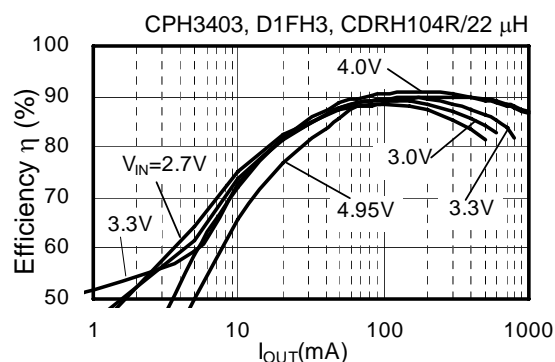

(5) S-8460B00AFT ( $V_{OUT} = 3.3\text{ V}$ )

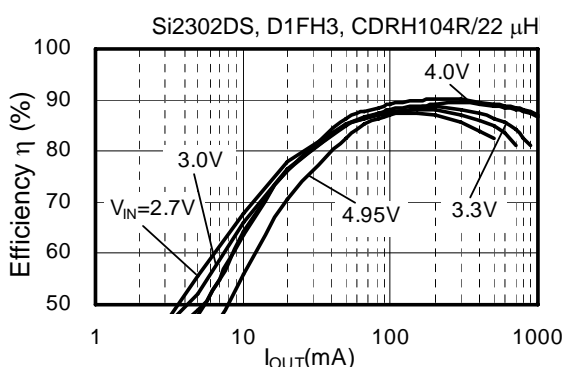

(6) S-8460B00AFT ( $V_{OUT} = 3.3\text{ V}$ )

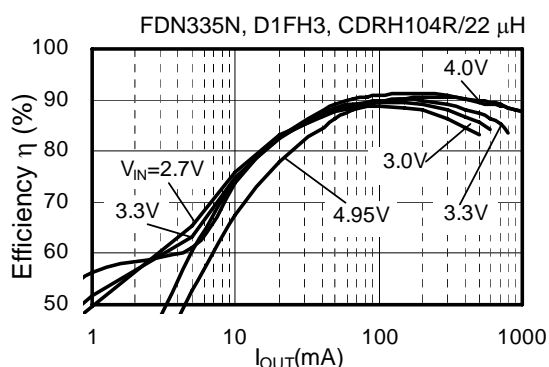

(7) S-8460B00AFT ( $V_{OUT} = 3.3\text{ V}$ )

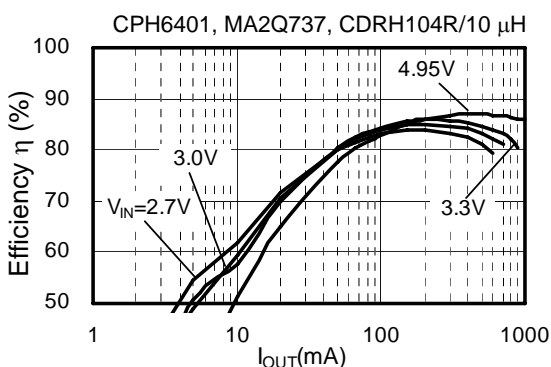

(8) S-8460B00AFT ( $V_{OUT} = 3.3\text{ V}$ )

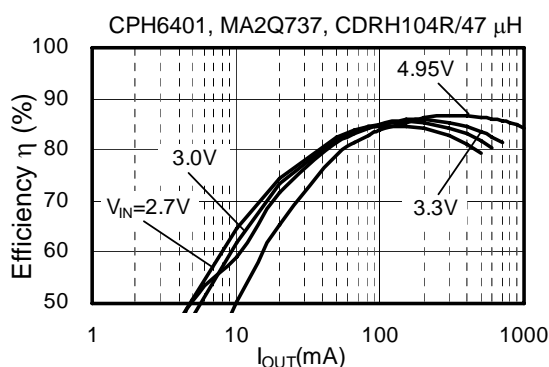



(9) S-8460B00AFT ( $V_{OUT} = 2.5\text{ V}$ )

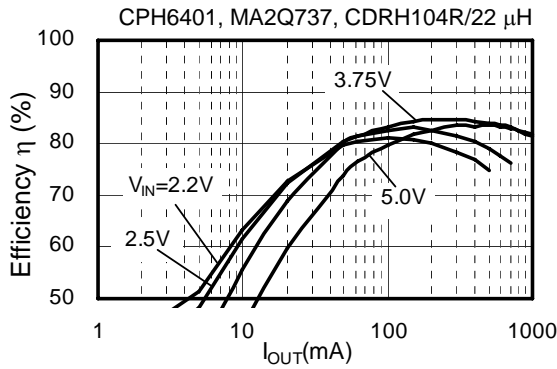

(10) S-8460B00AFT ( $V_{OUT} = 2.5\text{ V}$ )

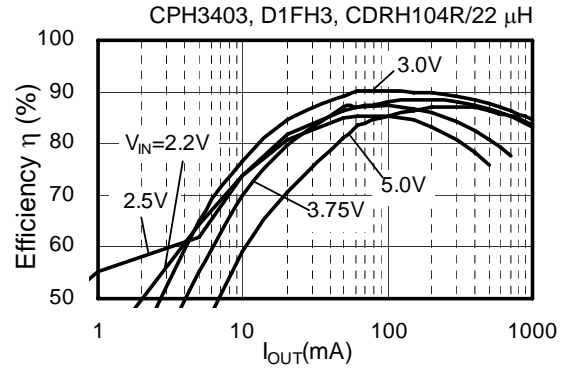

(11) S-8460B00AFT ( $V_{OUT} = 2.5\text{ V}$ )

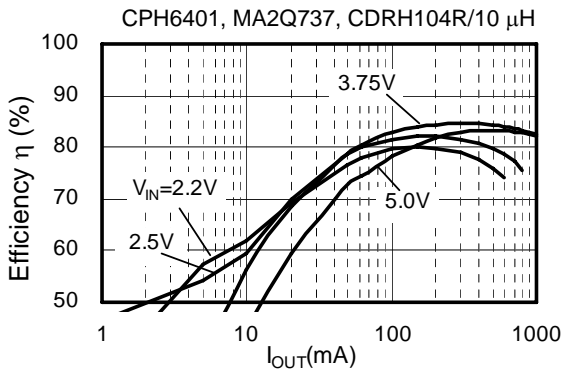

(12) S-8460B00AFT ( $V_{OUT} = 2.5\text{ V}$ )

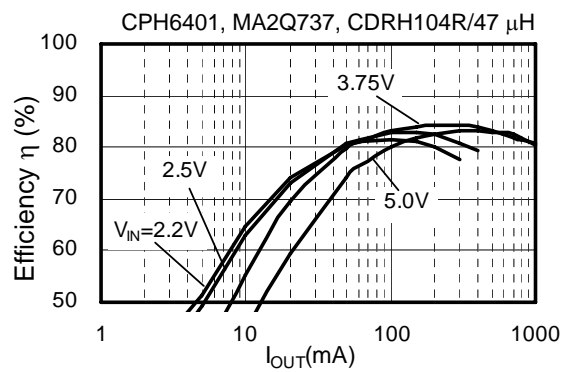

(13) S-8460B00AFT ( $V_{OUT} = 5.0\text{ V}$ )

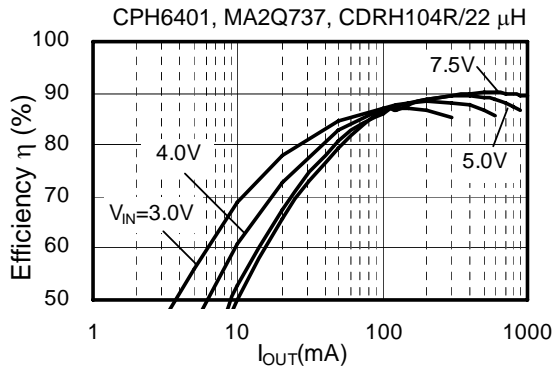

(14) S-8460B00AFT ( $V_{OUT} = 5.0\text{ V}$ )

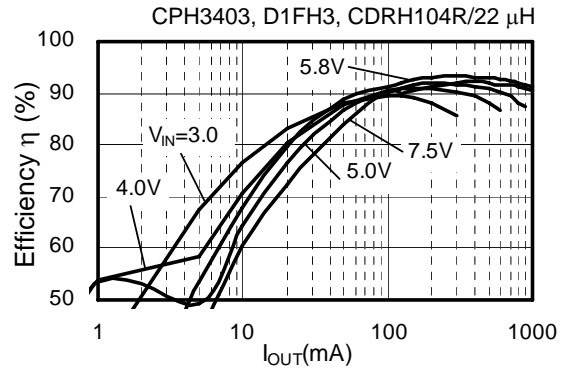

(15) S-8460B00AFT ( $V_{OUT} = 5.0\text{ V}$ )

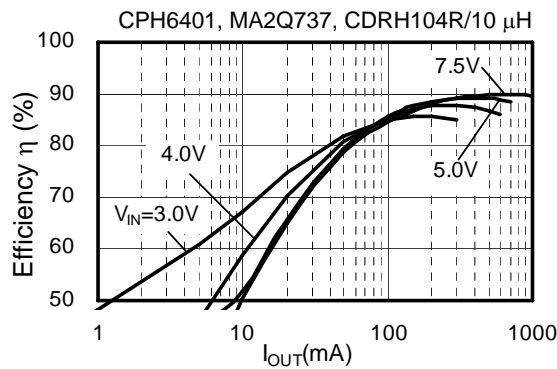

(16) S-8460B00AFT ( $V_{OUT} = 5.0\text{ V}$ )

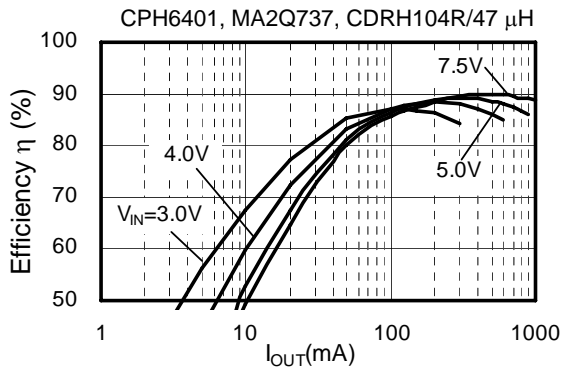

### 3. Input Voltage ( $V_{IN}$ ) vs. Efficiency ( $\eta$ ) Characteristics

The following shows the actual input voltage ( $V_{IN}$ ) vs. efficiency ( $\eta$ ) characteristics when the S-8460 is used under conditions (17) to (24) in Table 4.

(17) S-8460B00AFT ( $V_{OUT} = 3.3\text{ V}$ )

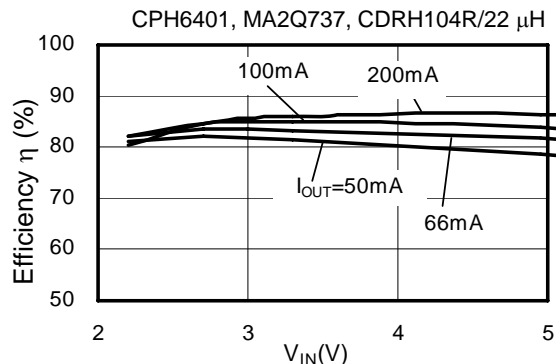

(18) S-8460B00AFT ( $V_{OUT} = 3.3\text{ V}$ )

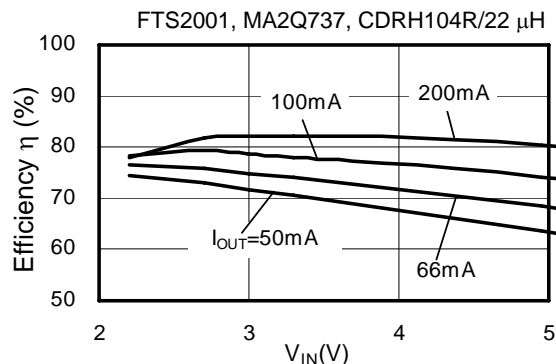

(19) S-8460B00AFT ( $V_{OUT} = 3.3\text{ V}$ )

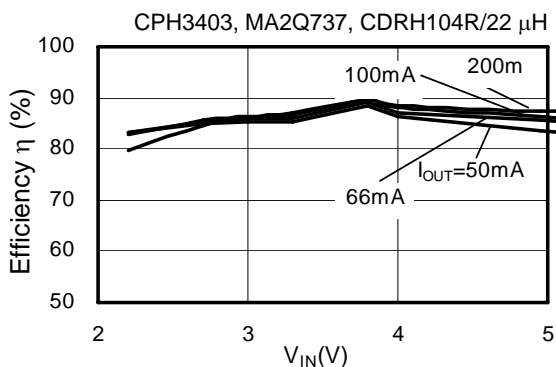

(20) S-8460B00AFT ( $V_{OUT} = 3.3\text{ V}$ )

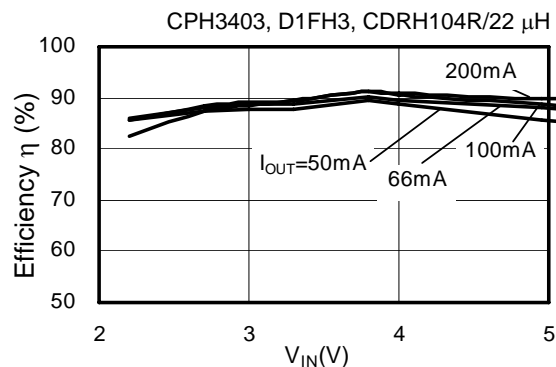

(21) S-8460B00AFT ( $V_{OUT} = 3.3\text{ V}$ )

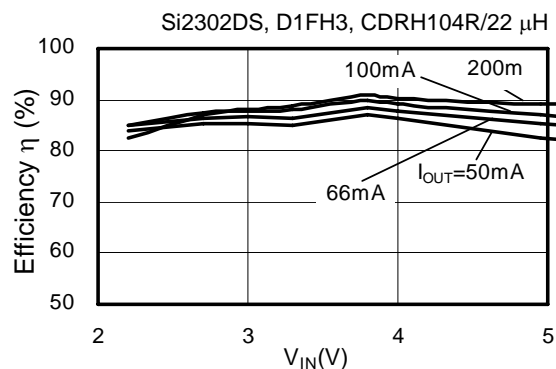

(22) S-8460B00AFT ( $V_{OUT} = 3.3\text{ V}$ )

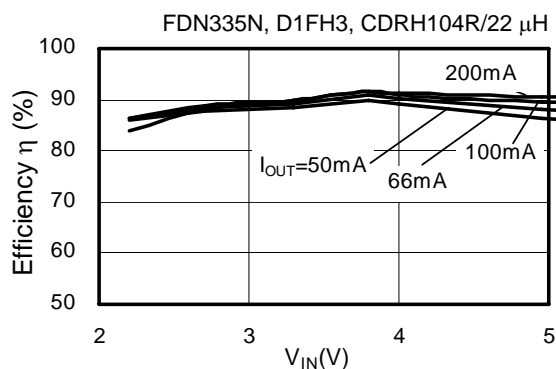

(23) S-8460B00AFT ( $V_{OUT} = 3.3\text{ V}$ )

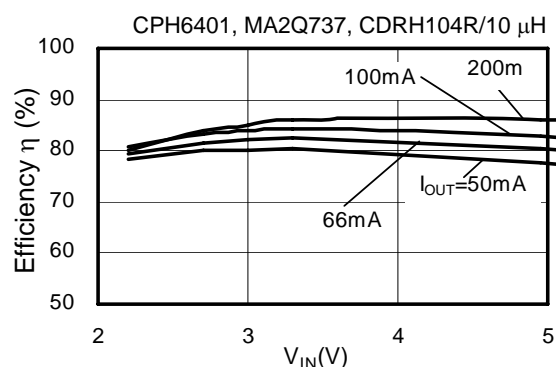

(24) S-8460B00AFT ( $V_{OUT} = 3.3\text{ V}$ )

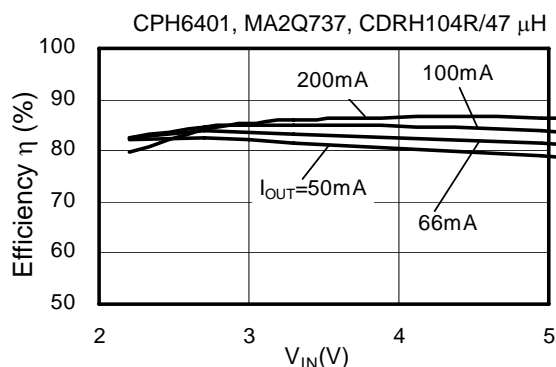

**4. Output Current ( $I_{OUT}$ ) vs. Output Voltage ( $V_{OUT}$ ) Characteristics**

The following shows the actual output current ( $I_{OUT}$ ) vs. output voltage ( $V_{OUT}$ ) characteristics when the S-8460 is used under conditions (25) to (27) in Table 4.

**(25) S-8460B00AFT ( $V_{OUT} = 3.3\text{ V}$ )**

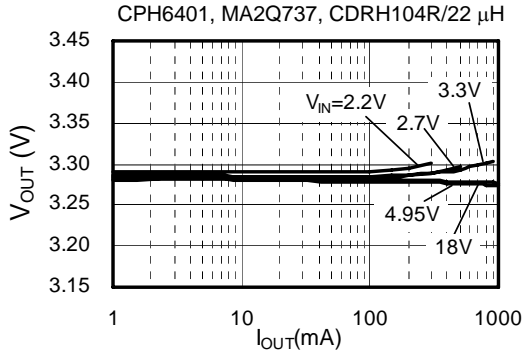

**(26) S-8460B00AFT ( $V_{OUT} = 2.5\text{ V}$ )**

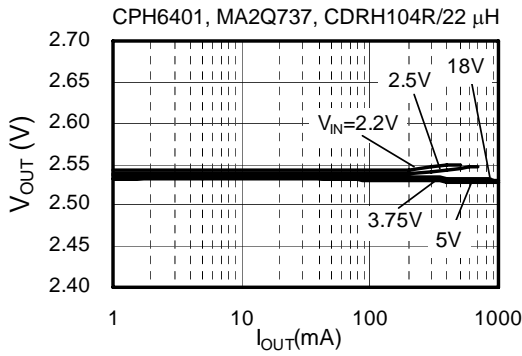

**(27) S-8460B00AFT ( $V_{OUT} = 5.0\text{ V}$ )**

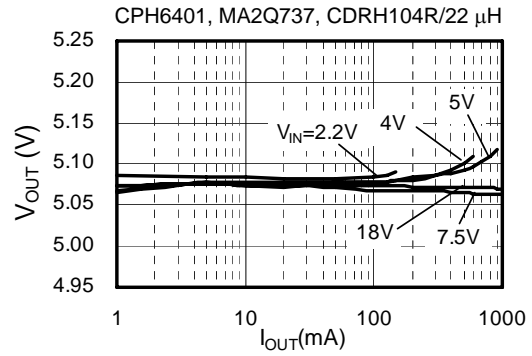

**5. Input Voltage ( $V_{IN}$ ) vs. Output Voltage ( $V_{OUT}$ ) Characteristics**

The following shows the actual input voltage ( $V_{IN}$ ) vs. output voltage ( $V_{OUT}$ ) characteristics when the S-8460 is used under conditions (28) to (30) in **Table 4**.

**(28) S-8460B00AFT ( $V_{OUT} = 3.3$  V)**

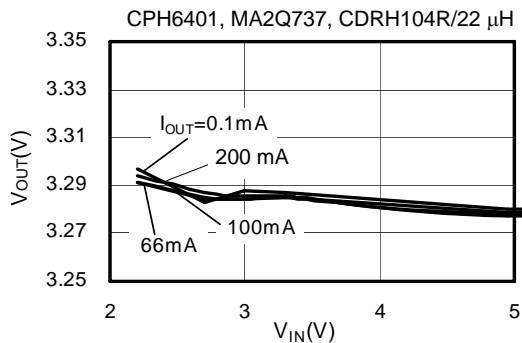

**(29) S-8460B00AFT ( $V_{OUT} = 2.5$  V)**

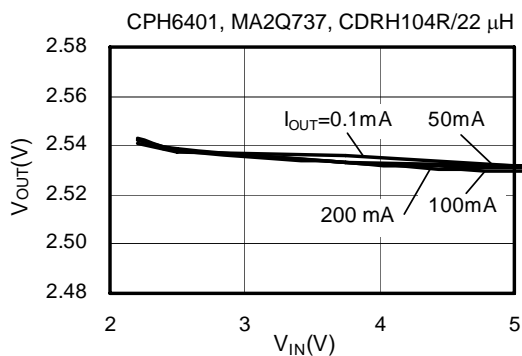

**(30) S-8460B00AFT ( $V_{OUT} = 5.0$  V)**

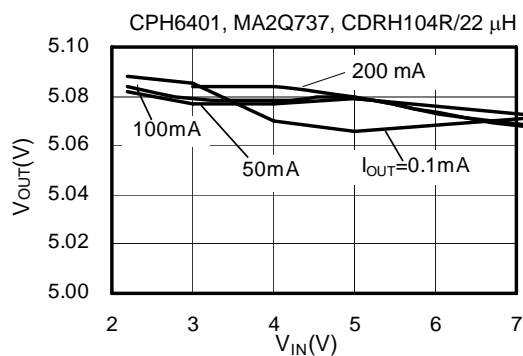

6. Input Voltage ( $V_{IN}$ ) vs. Ripple Voltage ( $V_{rip}$ ) Characteristics

The following shows the actual input voltage ( $V_{IN}$ ) vs. ripple voltage ( $V_{rip}$ ) characteristics when the S-8460 is used under conditions (31) to (35) in Table 5.

(31) S-8460B00AFT ( $V_{OUT} = 3.3 V$ )

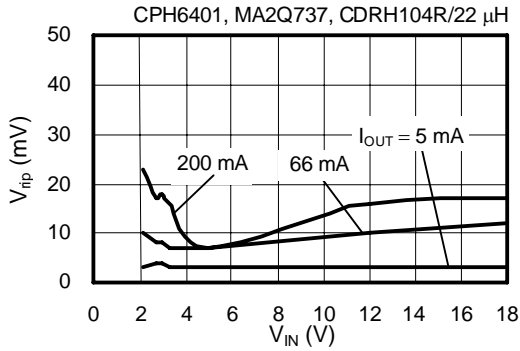

(32) S-8460B00AFT ( $V_{OUT} = 3.3 V$ )

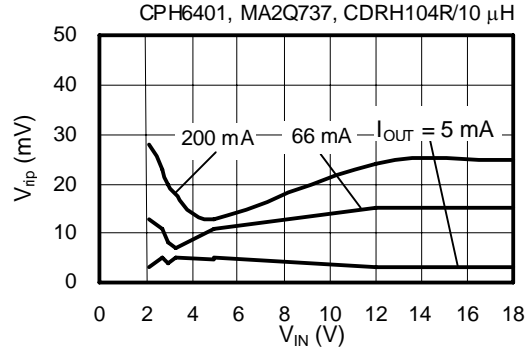

(33) S-8460B00AFT ( $V_{OUT} = 3.3 V$ )

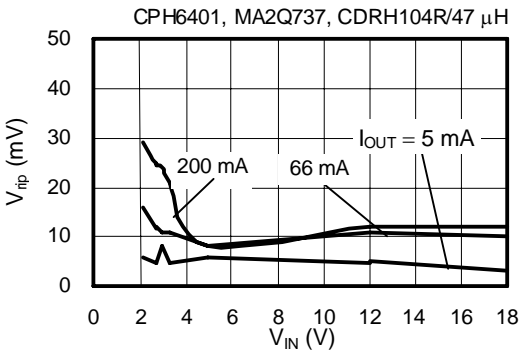

(34) S-8460B00AFT ( $V_{OUT} = 2.5 V$ )

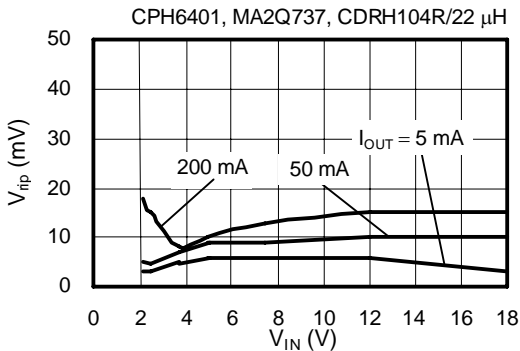

(35) S-8460B00AFT ( $V_{OUT} = 5.0 V$ )

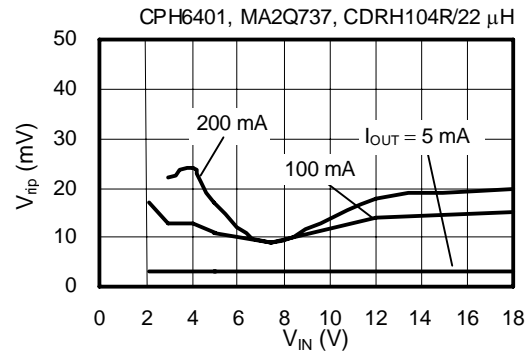

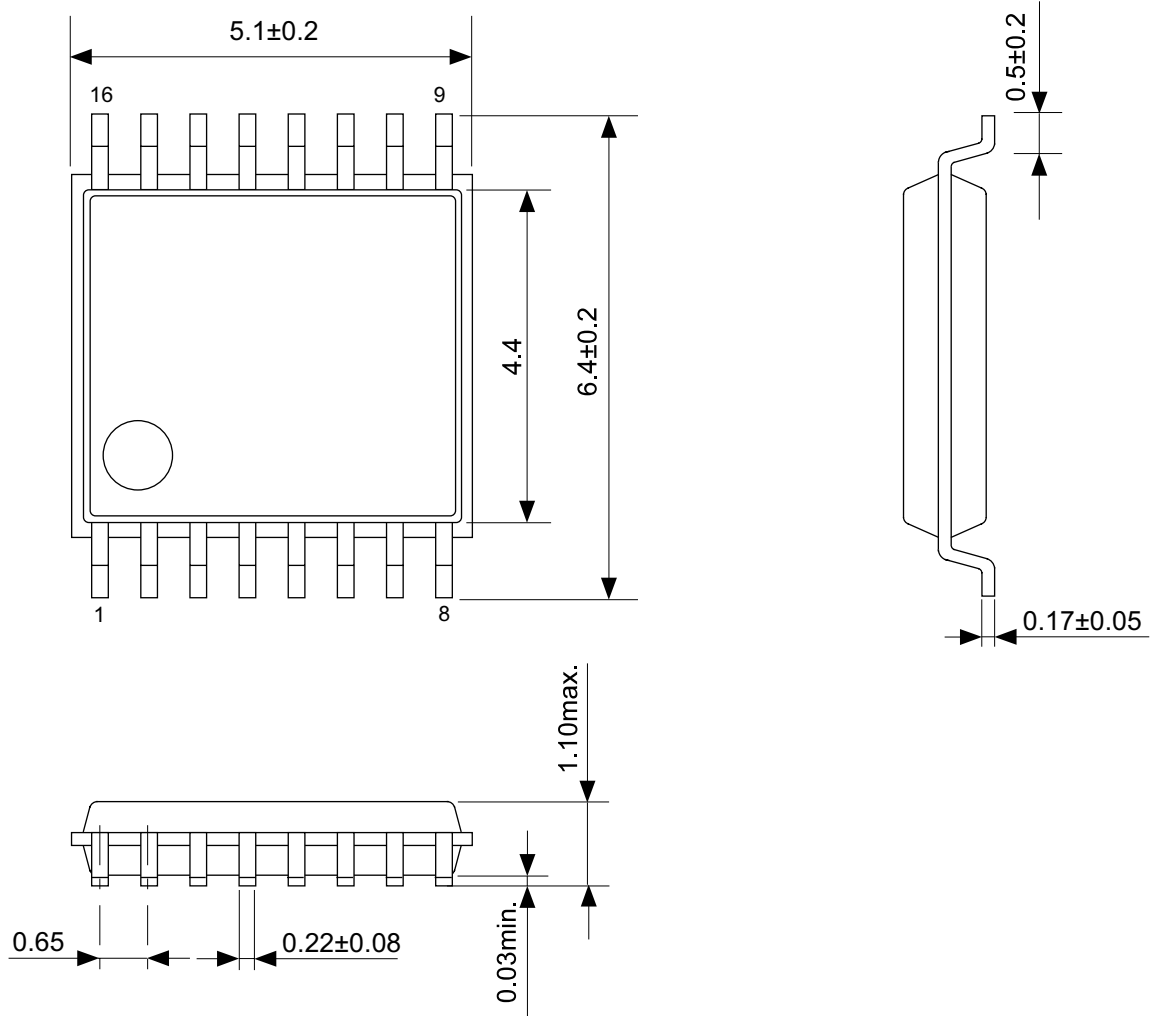

No. FT016-A-P-SD-1.1

TITLE	TSSOP16-A-PKG Dimensions
No.	FT016-A-P-SD-1.1
SCALE	
UNIT	mm
Seiko Instruments Inc.	

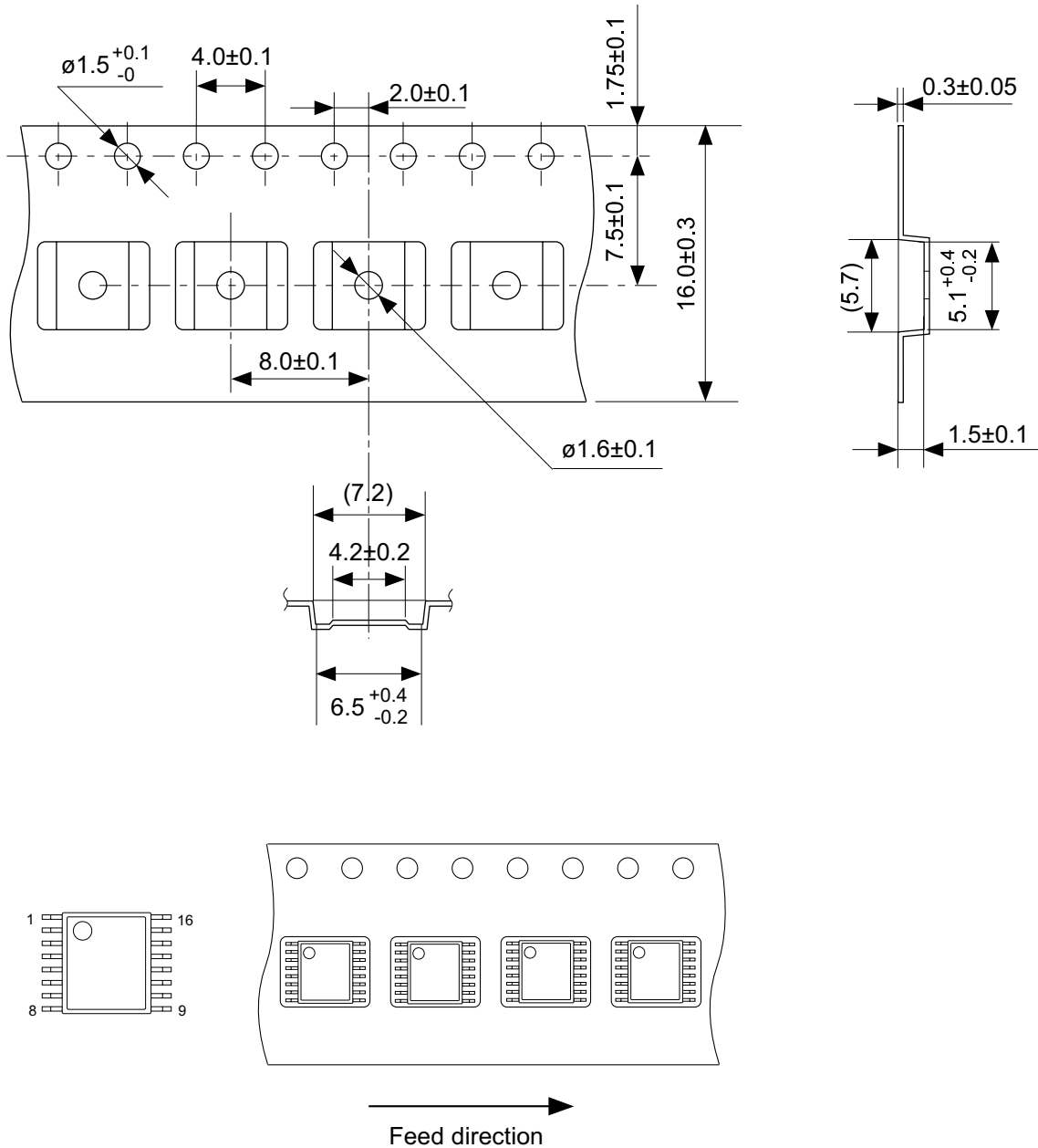

No. FT016-A-C-SD-1.1

TITLE	TSSOP16-A-Carrier Tape
No.	FT016-A-C-SD-1.1
SCALE	
UNIT	mm
Seiko Instruments Inc.	

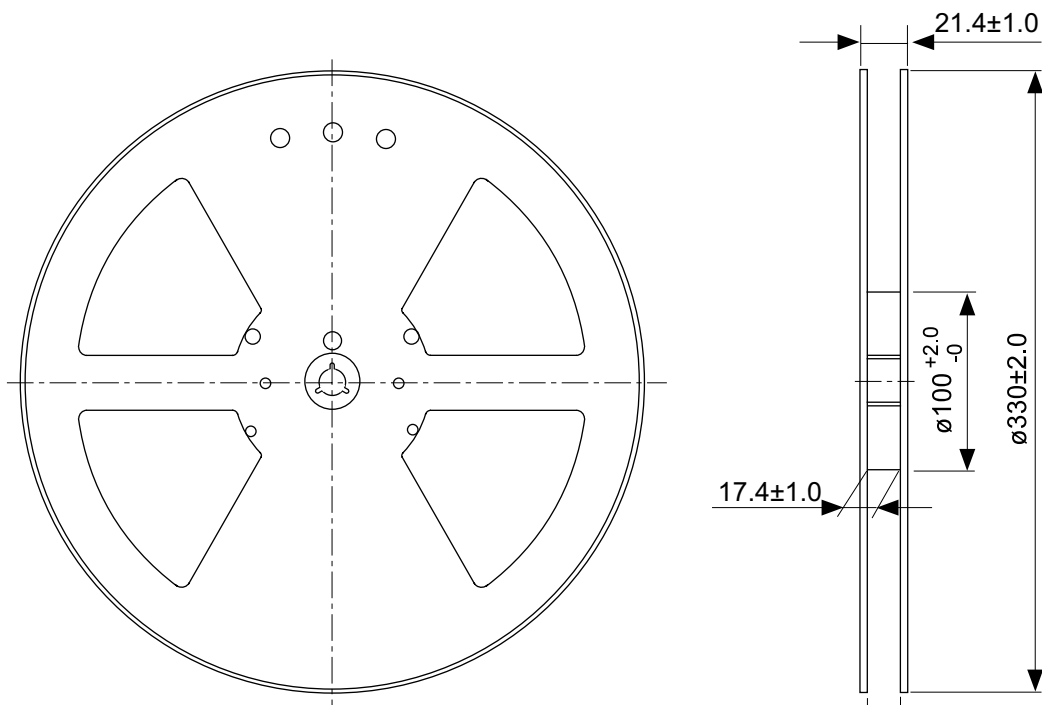

Enlarged drawing in the central part

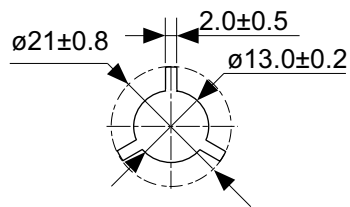

No. FT016-A-R-SD-1.1

TITLE	TSSOP16-A- Reel		
No.	FT016-A-R-SD-1.1		
SCALE		QTY.	2,000
UNIT	mm		
Seiko Instruments Inc.			



- The information described herein is subject to change without notice.
- Seiko Instruments Inc. is not responsible for any problems caused by circuits or diagrams described herein whose related industrial properties, patents, or other rights belong to third parties. The application circuit examples explain typical applications of the products, and do not guarantee the success of any specific mass-production design.
- When the products described herein are regulated products subject to the Wassenaar Arrangement or other agreements, they may not be exported without authorization from the appropriate governmental authority.
- Use of the information described herein for other purposes and/or reproduction or copying without the express permission of Seiko Instruments Inc. is strictly prohibited.
- The products described herein cannot be used as part of any device or equipment affecting the human body, such as exercise equipment, medical equipment, security systems, gas equipment, or any apparatus installed in airplanes and other vehicles, without prior written permission of Seiko Instruments Inc.
- Although Seiko Instruments Inc. exerts the greatest possible effort to ensure high quality and reliability, the failure or malfunction of semiconductor products may occur. The user of these products should therefore give thorough consideration to safety design, including redundancy, fire-prevention measures, and malfunction prevention, to prevent any accidents, fires, or community damage that may ensue.