

3-PHASE BRIDGE DRIVER

Features

- Floating channel designed for bootstrap operation
- Fully operational to +600 V
- Tolerant to negative transient voltage, dV/dt immune
- Gate drive supply range from 10 V to 20 V (IR2136/IR21368), 11.5 V to 20 V (IR21362D), or 12 V to 20 V (IR21363/IR21365/IR21366/IR21367)
- Undervoltage lockout for all channels
- Over-current shutdown turns off all six drivers
- Independent 3 half-bridge drivers
- Matched propagation delay for all channels
- Cross-conduction prevention logic
- Low side output out of phase with inputs. High side outputs out of phase (IR213(6,63, 65, 66, 67, 68)), or in phase (IR21362) with inputs
- 3.3 V logic compatible
- Lower di/dt gate drive for better noise immunity
- Externally programmable delay for automatic fault clear
- All parts are LEAD-FREE

Packages

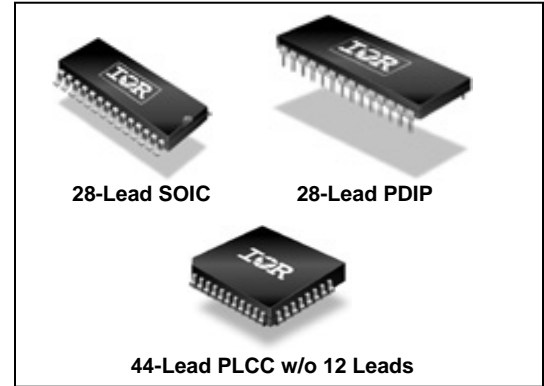

Description

The IR2136x (J&S) are high voltage, high speed power MOSFET and IGBT drivers with three independent high and low side referenced output channels for 3-phase applications. Proprietary HVIC technology enables ruggedized monolithic construction. Logic inputs are compatible with CMOS or LSTTL outputs, down to 3.3 V logic. A current trip function which terminates all six outputs can be derived from an external current sense resistor. An enable function is available to terminate all six outputs simultaneously. An open-drain FAULT signal is provided to indicate that an overcurrent or undervoltage shutdown has occurred. Overcurrent fault conditions are cleared automatically after a delay programmed externally via an RC network connected to the RCIN input. The output drivers feature a high pulse current buffer stage designed for minimum driver cross-conduction. Propagation delays are matched to simplify use in high frequency applications. The floating channels can be used to drive N-channel power MOSFETs or IGBTs in the high side configuration which operates up to 600 V.

Feature Comparison: IR213(6,62,63,65,66,67,68)

Part	IR2136	IR21362	IR21363	IR21365	IR21366	IR21367	IR21368
Input Logic	$\overline{\text{HIN}}, \overline{\text{LIN}}$	$\text{HIN}, \overline{\text{LIN}}$	$\overline{\text{HIN}}, \overline{\text{LIN}}$	$\overline{\text{HIN}}, \overline{\text{LIN}}$	$\overline{\text{HIN}}, \overline{\text{LIN}}$	$\overline{\text{HIN}}, \overline{\text{LIN}}$	$\overline{\text{HIN}}, \overline{\text{LIN}}$
Ton (typ.)	400 ns	400 ns	400 ns	400 ns	250 ns	250 ns	400 ns
Toff (typ.)	380ns	380 ns	380 ns	380 ns	180 ns	180 ns	380 ns
V _{in} (typ.)	2.7 V	2.7 V	2.7 V	2.7 V	2.0 V	2.0 V	2.0 V
V _{ic} (typ.)	1.7 V	1.7 V	1.7 V	1.7 V	1.3 V	1.3 V	1.3 V
V _{trip+}	0.46 V	0.46 V	0.46 V	4.3 V	0.46 V	4.3 V	4.3 V
UVCC/BS+	8.9 V	10.4 V	11.2 V	11.2 V	11.2 V	11.2 V	8.9 V
UVCC/BS-	8.2 V	9.4 V	11.0 V	11.0 V	11.0 V	11.0 V	8.2 V

An enable function is available to terminate all six outputs simultaneously. An open-drain FAULT signal is provided to indicate that an overcurrent or undervoltage shutdown has occurred. Overcurrent fault conditions are cleared automatically after a delay programmed externally via an RC network connected to the RCIN input. The output drivers feature a high pulse current buffer stage designed for minimum driver cross-conduction. Propagation delays are matched to simplify use in high frequency applications. The floating channels can be used to drive N-channel power MOSFETs or IGBTs in the high side configuration which operates up to 600 V.

Typical Connection

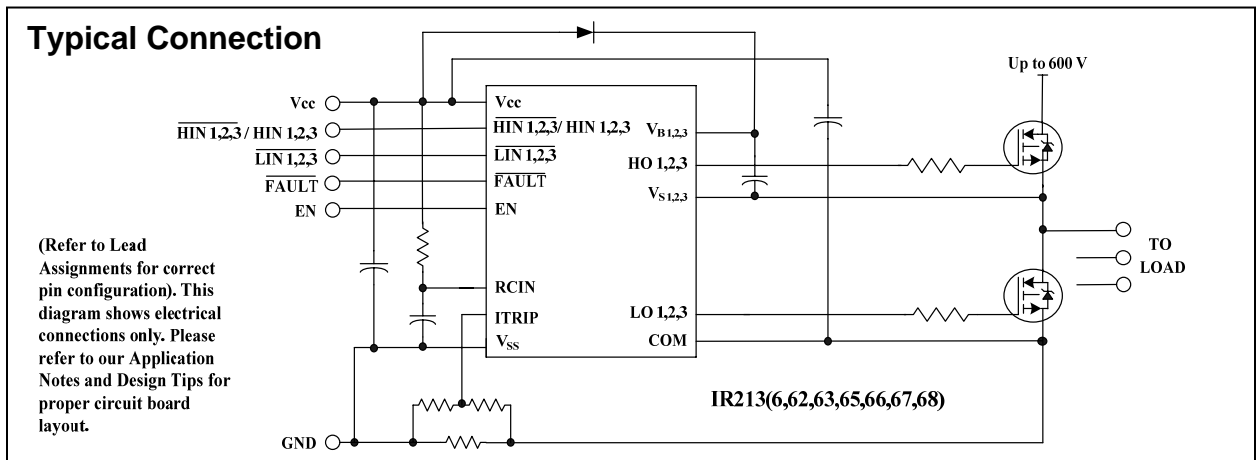

Absolute Maximum Ratings

Absolute Maximum Ratings indicate sustained limits beyond which damage to the device may occur. All voltage parameters are absolute voltages referenced to COM. The thermal resistance and power dissipation ratings are measured under board mounted and still air conditions.

Symbol	Definition	Min	Max	Units	
V_S	High side offset voltage	$V_{B1,2,3} - 25$	$V_{B1,2,3} + 0.3$	V	
V_B	High side floating supply voltage	-0.3	625		
V_{HO}	High side floating output voltage	$V_{S1,2,3} - 0.3$	$V_{B1,2,3} + 0.3$		
V_{CC}	Low side and logic fixed supply voltage	-0.3	25		
V_{SS}	Logic ground	$V_{CC} - 25$	$V_{CC} + 0.3$		
$V_{LO1,2,3}$	Low side output voltage	-0.3	$V_{CC} + 0.3$		
V_{IN}	Input voltage LIN, HIN, ITRIP, EN	$V_{SS} - 0.3$	Lower of ($V_{SS} + 15$) or ($V_{CC} + 0.3$)		
V_{RCIN}	RCIN input voltage	$V_{SS} - 0.3$	$V_{CC} + 0.3$		
V_{FLT}	FAULT output voltage	$V_{SS} - 0.3$	$V_{CC} + 0.3$		
dV/dt	Allowable offset voltage slew rate	—	50		V/ns
P_D	Package power dissipation @ $T_A \leq +25^\circ\text{C}$	(28 lead PDIP)	—	1.5	W
		(28 lead SOIC)	—	1.6	
		(44 lead PLCC)	—	2.0	
R_{thJA}	Thermal resistance, junction to ambient	(28 lead PDIP)	—	83	$^\circ\text{C}/\text{W}$
		(28 lead SOIC)	—	78	
		(44 lead PLCC)	—	63	
T_J	Junction temperature	—	150	$^\circ\text{C}$	
T_S	Storage temperature	-55	150		
T_L	Lead temperature (soldering, 10 seconds)	—	300		

Recommended Operating Conditions

The input/output logic-timing diagram is shown in Fig. 1. For proper operation the device should be used within the recommended conditions. All voltage parameters are absolute referenced to COM. The V_S offset ratings are tested with all supplies biased at a 15 V differential.

Symbol	Definition	Min	Max	Units	
$V_{B1,2,3}$	High side floating supply voltage	IR213(6,68)	$V_{S1,2,3} + 10$	$V_{S1,2,3} + 20$	V
		IR21362	$V_{S1,2,3} + 11.5$	$V_{S1,2,3} + 20$	
		IR213(6,63,65,66,67)	$V_{S1,2,3} + 12$	$V_{S1,2,3} + 20$	
$V_{S1,2,3}$	High side floating supply offset voltage	Note 1	600		
$V_{HO1,2,3}$	High side output voltage	$V_{S1,2,3}$	$V_{B1,2,3}$		
$V_{LO1,2,3}$	Low side output voltage	0	V_{CC}		
V_{CC}	Low side and logic fixed supply voltage	IR213(6,68)	10	20	
		IR21362	11.5	20	
		IR213(6,63,65,66,67)	12	20	
V_{SS}	Logic ground	-5	5		
V_{FLT}	FAULT output voltage	V_{SS}	V_{CC}		
V_{RCIN}	RCIN input voltage	V_{SS}	V_{CC}		

Note 1: Logic operational for V_S of (COM - 5 V) to (COM + 600 V). Logic state held for V_S of (COM - 5 V) to (COM - V_{BS}). (Please refer to the Design Tip DT97-3 for more details).

Note 2: All input pins and the ITRIP and EN pins are internally clamped with a 5.2 V zener diode.

Recommended Operating Conditions - (Continued)

The input/output logic-timing diagram is shown in Fig. 1. For proper operation the device should be used within the recommended conditions. All voltage parameters are absolute referenced to COM. The V_S offset ratings are tested with all supplies biased at a 15 V differential.

Symbol	Definition	Min	Max	Units
V_{ITRIP}	ITRIP input voltage	V_{SS}	$V_{SS} + 5$	V
V_{IN}	Logic input voltage \overline{LIN} , \overline{HIN} (IR213(6,63,65,66,67,68)), HIN (IR21362), EN	V_{SS}	$V_{SS} + 5$	
T_A	Ambient temperature	-40	125	°C

Note 2: All input pins and the ITRIP and EN pins are internally clamped with a 5.2 V zener diode.

Static Electrical Characteristics

V_{BIAS} ($V_{CC}, V_{BS1,2,3}$) = 15 V unless otherwise specified. The V_{IN} , V_{TH} , and I_{IN} parameters are referenced to V_{SS} and are applicable to all six channels ($\overline{HIN1,2,3}$ and $\overline{LIN1,2,3}$). The V_O and I_O parameters are referenced to COM and $V_{S1,2,3}$ and are applicable to the respective output leads: HO1,2,3 and LO1,2,3.

Symbol	Definition	Min	Typ	Max	Units	Test Conditions	
V_{IH}	Logic "0" input voltage $\overline{LIN1,2,3}$, $\overline{HIN1,2,3}$ IR213(6,63,65)	3.0	—	—	V		
	Logic "1" input voltage $HIN1,2,3$ IR21362						
V_{IL}	Logic "0" input voltage $\overline{LIN1,2,3}$, $\overline{HIN1,2,3}$ IR213(66,67,68)	2.5	—	—			
	Logic "1" input Voltage $\overline{LIN1,2,3}$, $\overline{HIN1,2,3}$ IR213(6,63,65)	—	—	0.8			
V_{IL}	Logic "0" input voltage $HIN1,2,3$ IR21362	—	—	0.8			
	Logic "0" input voltage $\overline{LIN1,2,3}$, $\overline{HIN1,2,3}$ IR213(66,67,68)	—	—	0.8			
$V_{EN,TH+}$	Enable positive going threshold	—	—	3			
$V_{EN,TH-}$	Enable negative going threshold	0.8	—	—			
$V_{IT,TH+}$	ITRIP positive going threshold	IR2136(2)(3)(6)	0.37	0.46			0.55
		IR21365(7)(8)	3.85	4.30			4.75
$V_{IT,HYS}$	ITRIP input hysteresis	IR2136(2)(3)(6)	—	0.07	—		
		IR21365(7)(8)	—	.15	—		
$V_{RCIN, TH+}$	RCIN positive going threshold	—	8	—			
$V_{RCIN, HYS}$	RCIN input hysteresis	—	3	—			
V_{OH}	High level output voltage, $V_{BIAS} - V_O$	—	0.9	1.4		$I_O = 20$ mA	
V_{OL}	Low level output voltage, V_O	—	0.4	0.6			
V_{CCUV+} V_{BSUV+}	V_{CC} and V_{BS} supply undervoltage positive going threshold	IR2136(8)	8.0	8.9	9.8		
		IR21362	9.6	10.4	11.2		
		IR21363(5)(6)(7)	10.6	11.1	11.6		

Static Electrical Characteristics - (Continued)

$V_{BIAS} (V_{CC}, V_{BS1,2,3}) = 15\text{ V}$ unless otherwise specified. The V_{IN} , V_{TH} , and I_{IN} parameters are referenced to V_{SS} and are applicable to all six channels (HIN1,2,3 and LIN1,2,3). The V_O and I_O parameters are referenced to COM and $V_{S1,2,3}$ and are applicable to the respective output leads: HO1,2,3 and LO1,2,3.

Symbol	Definition	Min	Typ	Max	Units	Test Conditions	
V_{CCUV-} V_{BSUV-}	V_{CC} and V_{BS} supply undervoltage negative going threshold	IR2136(8)	7.4	8.2	9.0	V	
		IR21362	8.6	9.4	10.2		
		IR2136(3,5,6,7)	10.4	10.9	11.4		
V_{CCUVH} V_{BSUVH}	V_{CC} and V_{BS} supply undervoltage lockout hysteresis	IR2136	0.3	0.7	—		
		IR21362	0.5	1.0	—		
		IR2136(3,5)	—	0.2	—		
I_{LK}	Offset supply leakage current	—	—	50	μA	$V_{B1,2,3} = V_{S1,2,3} = 600\text{ V}$	
I_{QBS}	Quiescent V_{BS} supply current	—	70	120	μA	$V_{IN} = 0\text{ V or } 5\text{ V}$	
I_{QCC}	Quiescent V_{CC} supply current	—	1.6	2.3	mA		
$V_{IN,CLAMP}$	Input clamp voltage (HIN, LIN, ITRIP and EN)	4.9	5.2	5.5	V	$I_{IN} = 100\ \mu\text{A}$	
I_{LIN+}	Input bias current (LOUT = HI)	IR2136(2,3,5)	—	200	300	μA	$V_{LIN} = 5\text{ V}$
		IR2136(6,7,8)	—	30	100		$V_{LIN} = 0\text{ V}$
I_{LIN-}	Input bias current (LOUT = LO)	IR2136(2,3,5)	—	100	220		$V_{LIN} = 5\text{ V}$
		IR2136(6,7,8)	—	0	1		$V_{LIN} = 0\text{ V}$
I_{HIN+}	Input bias current (HOOUT = HI)	IR2136(3,5)	—	200	300		$V_{HIN} = 5\text{ V}$
		IR21362	—	30	100		
		IR2136(6,7,8)	—	30	100		
I_{HIN-}	Input bias current (HOOUT = LO)	IR2136(3,5)	—	100	220		$V_{HIN} = 0\text{ V}$
		IR2136(2,6,7,8)	—	0	1		
I_{ITRIP+}	“High” ITRIP input bias current	—	30	100			$V_{ITRIP} = 5\text{ V}$
I_{ITRIP-}	“Low” ITRIP input bias current	—	0	1			$V_{ITRIP} = 0\text{ V}$
I_{EN+}	“High” ENABLE input bias current	—	30	100			$V_{ENABLE} = 5\text{ V}$
I_{EN-}	“Low” ENABLE input bias current	—	0	1			$V_{ENABLE} = 0\text{ V}$
I_{RCIN}	RCIN input bias current	—	0	1			$V_{rcin} = 0\text{ V or } 15\text{ V}$
I_{O+}	Output high short circuit pulsed current	120	200	—	mA	$V_O = 0\text{ V, PW} \leq 10\ \mu\text{s}$	
I_{O-}	Output low short circuit pulsed current	250	350	—	mA	$V_O = 15\text{ V, PW} \leq 10\ \mu\text{s}$	
R_{on_RCIN}	RCIN low on resistance	—	50	100	Ω		
R_{on_FAULT}	$\overline{\text{FAULT}}$ low on resistance	—	50	100	Ω		

Dynamic Electrical Characteristics

$V_{CC} = V_{BS} = V_{BIAS} = 15\text{ V}$, $V_{S1,2,3} = V_{SS} = \text{COM}$, $T_A = 25\text{ }^\circ\text{C}$ and $C_L = 1000\text{ pF}$ unless otherwise specified.

Symbol	Definition	Min	Typ	Max	Units	Test Conditions		
t_{on}	Turn-on propagation delay	IR2136(2,3,5,8)	300	425	550	ns	$V_{IN} = 0\text{ V} \& 5\text{ V}$	
		IR2136(6,7)	—	250	—			
t_{off}	Turn-off propagation delay	IR2136(2,3,5,8)	250	400	550			
		IR2136(6,7)	—	180	—			
t_r	Turn-on rise time	—	125	190				
t_f	Turn-off fall time	—	50	75				
t_{EN}	ENABLE low to output shutdown propagation delay	IR2136(2,3,5,8)	300	450	600			$V_{IN}, V_{EN} = 0\text{ V}$ or 5 V
		IR2136(6,7)	100	250	400			
t_{ITRIP}	ITRIP to output shutdown propagation delay	500	750	1000	$V_{ITRIP} = 5\text{ V}$			
t_{bl}	ITRIP blanking time	100	150	—	$V_{IN} = 0\text{ V}$ or 5 V $V_{ITRIP} = 5\text{ V}$			
t_{FLT}	ITRIP to $\overline{\text{FAULT}}$ propagation delay	400	600	800	$V_{IN} = 0\text{ V} \& 5\text{ V}$			
t_{FILIN}	Input filter time (HIN, LIN) (IR213(6,62,63,65,68) only)	100	200	—				
t_{FLTCLR}	FAULT clear time RCIN: $R = 2\text{ M}\Omega$, $C = 1\text{ nF}$	1.3	1.65	2	ms	$V_{IN} = 0\text{ V}$ or 5 V $V_{ITRIP} = 0\text{ V}$		
DT	Deadtime	220	290	360	ns	$V_{IN} = 0\text{ V} \& 5\text{ V}$ External dead time $>400\text{ ns}$		
MT	Matching delay ON and OFF	—	40	75				
MDT	Matching delay, $\max(t_{on}, t_{off}) - \min(t_{on}, t_{off})$, (t_{on}, t_{off} are applicable to all 3 channels)	—	25	70				
PM	Output pulse width matching (pwin-pwout) (Fig.2)	—	40	75				

Note: For high side PWM, HIN pulse width must be $\geq 1\text{ }\mu\text{s}$.

VCC	VBS	ITRIP	ENABLE	FAULT	LO1,2,3	HO1,2,3
<UVCC	X	X	X	0 (note 1)	0	0
15 V	<UVBS	0 V	5 V	high imp	LIN1,2,3	0
15 V	15 V	0 V	5 V	high imp	LIN1,2,3	HIN1,2,3
15 V	15 V	$>V_{ITRIP}$	5 V	0 (note 2)	0	0
15 V	15 V	0 V	0 V	high imp	0	0

Note 1: A shoot-through prevention logic prevents LO1,2,3 and HO1,2,3 for each channel from turning on simultaneously.

Note 2: UVCC is not latched, when $V_{CC} > UV_{CC}$, FAULT returns to high impedance.

Note 3: When $ITRIP < V_{ITRIP}$, FAULT returns to high-impedance after RCIN pin becomes greater than 8 V (@ $V_{CC} = 15\text{ V}$).

Functional Block Diagram



Functional Block Diagram



Lead Definitions

Symbol	Description
V _{CC}	Low side and logic fixed supply
V _{SS}	Logic ground
HIN _{1,2,3} HIN _{1,2,3}	Logic inputs for high side gate driver outputs (HO _{1,2,3}), out of phase [IR213(6,63,65,66,67,68)] Logic inputs for high side gate driver outputs (HO _{1,2,3}), in phase (IR21362)
LIN _{1,2,3}	Logic input for low side gate driver outputs (LO _{1,2,3}), out of phase
FAULT	Indicates over-current (ITRIP) or low-side undervoltage lockout has occurred. Negative logic, open-drain output
EN	Logic input to enable I/O functionality. I/O logic functions when ENABLE is high (i.e., positive logic) No effect on FAULT and not latched
ITRIP	Analog input for overcurrent shutdown. When active, ITRIP shuts down outputs and activates FAULT and RCIN low. When ITRIP becomes inactive, FAULT stays active low for an externally set time T _{FLTCLR} , then automatically becomes inactive (open-drain high impedance).
RCIN	External RC network input used to define FAULT CLEAR delay, T _{FLTCLR} , approximately equal to R*C. When RCIN>8 V, the FAULT pin goes back into open-drain high-impedance
COM	Low side gate drivers return
V _{B1,2,3}	High side floating supply
HO _{1,2,3}	High side gate driver outputs
V _{S1,2,3}	High voltage floating supply return
LO _{1,2,3}	Low side gate driver outputs

Note: All input pins and the ITRIP pin are internally clamped with a 5.2 V zener diode.

Lead Assignments

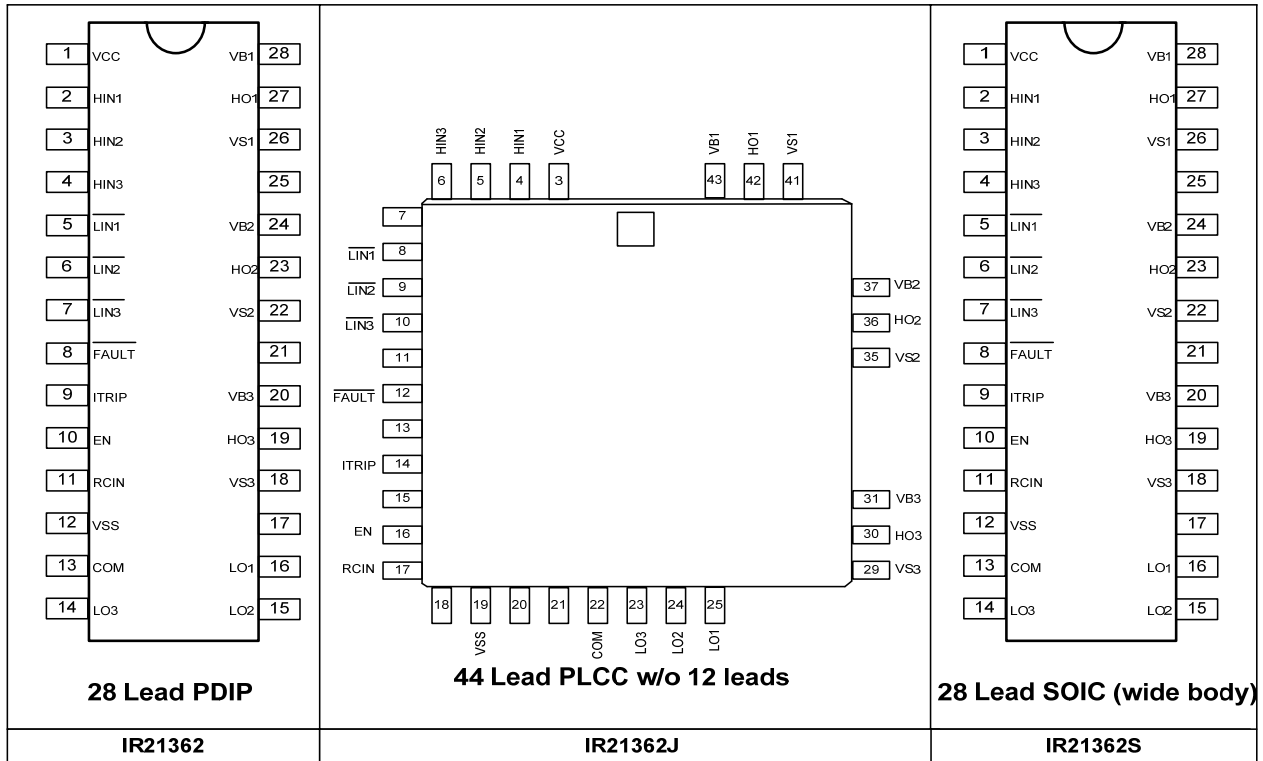
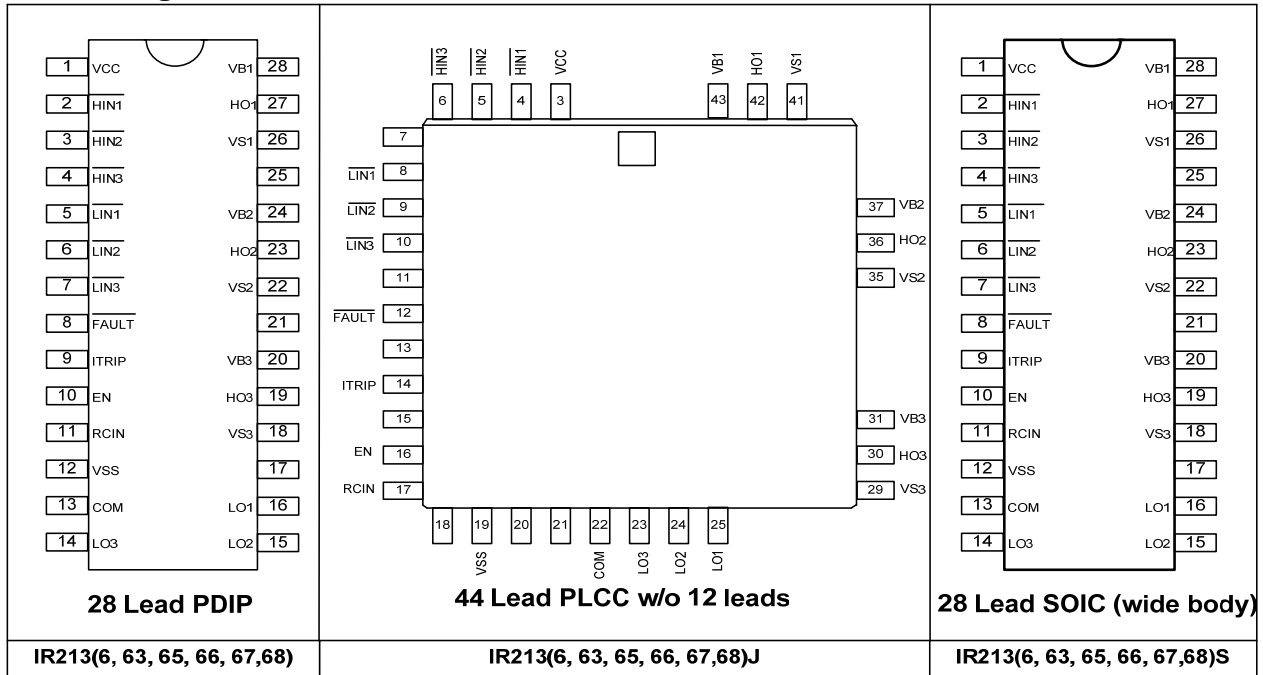

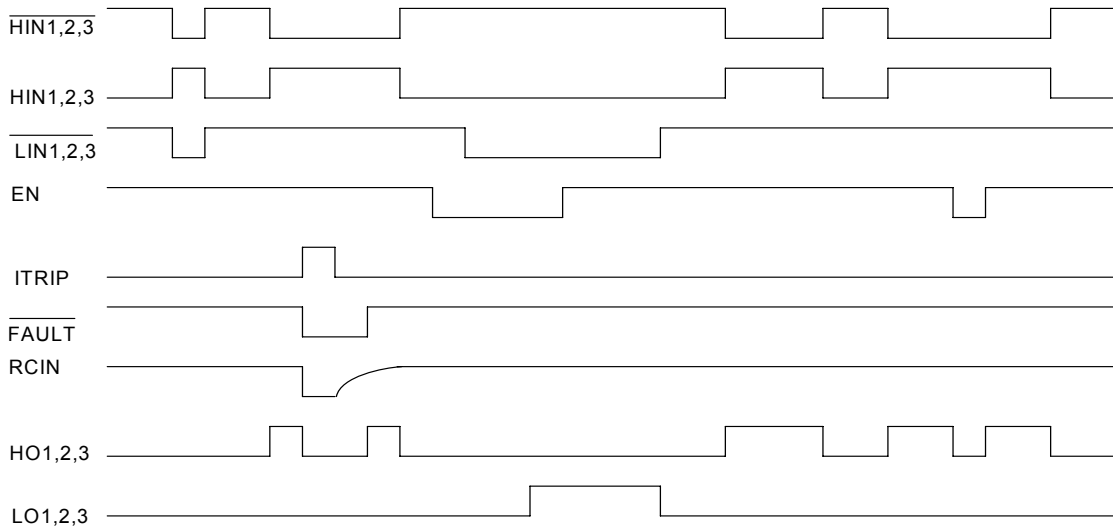

Fig. 1. Input/Output Timing Diagram



Fig. 2. Switching Time Waveforms



Fig. 3. Output Enable Timing Waveform



Fig. 4. Internal Deadtime Timing Waveforms

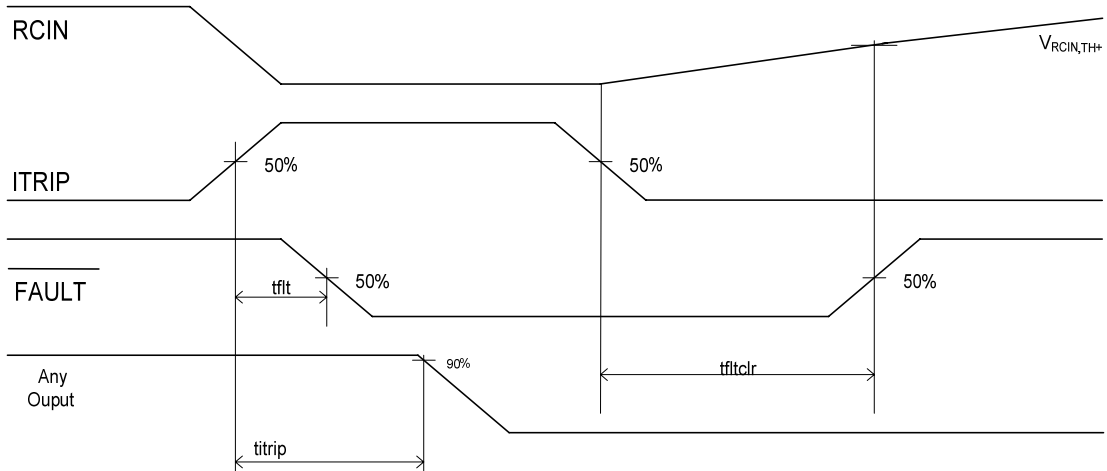

Fig. 5. ITRIP/RCIN Timing Waveforms

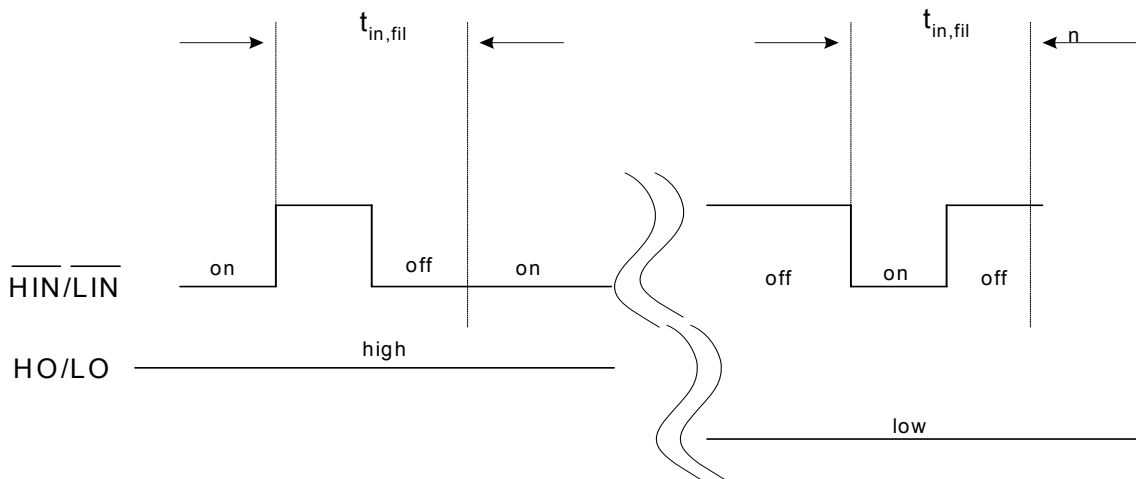

Fig. 6. Input Filter Function

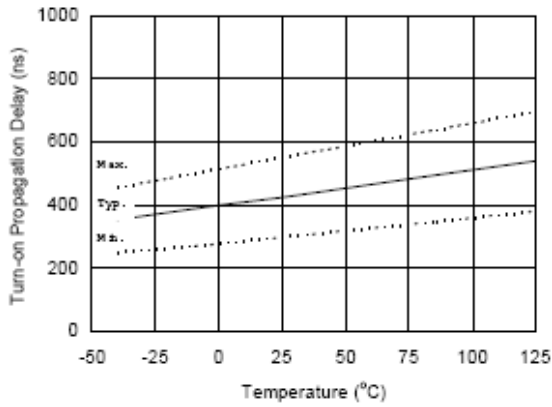

Figure 6A. Turn-on Propagation Delay vs. Temperature

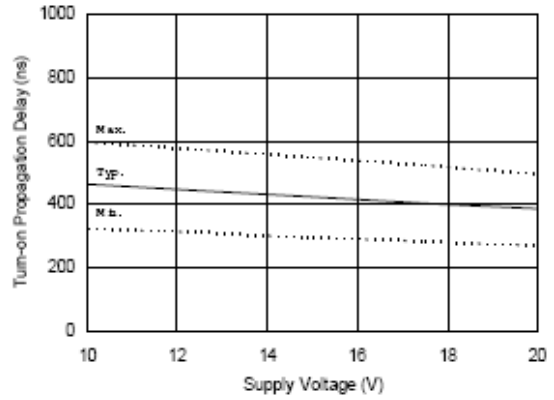

Figure 6B. Turn-on Propagation Delay vs. Supply Voltage



Figure 6C. Turn-on Propagation Delay vs. Input Voltage



Figure 7A. Turn-off Propagation Delay vs. Temperature

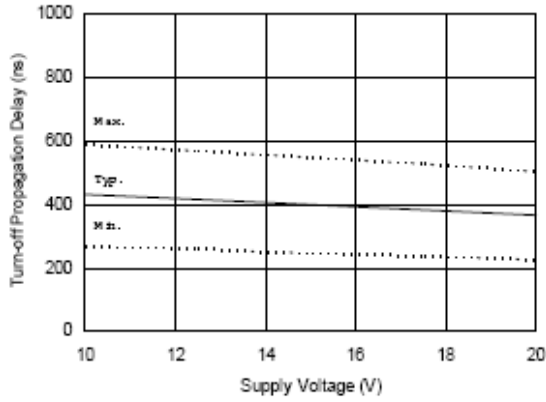

Figure 7B. Turn-off Propagation Delay vs. Supply Voltage

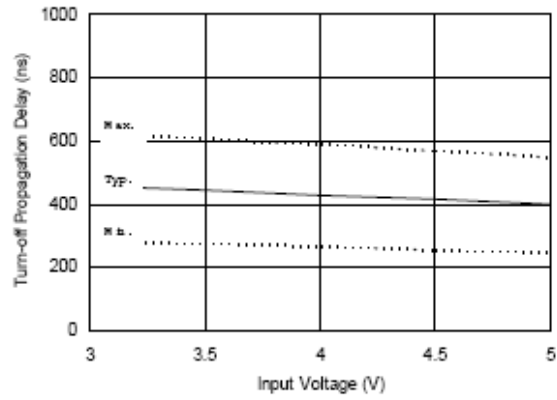

Figure 7C. Turn-off Propagation Delay vs. Input Voltage

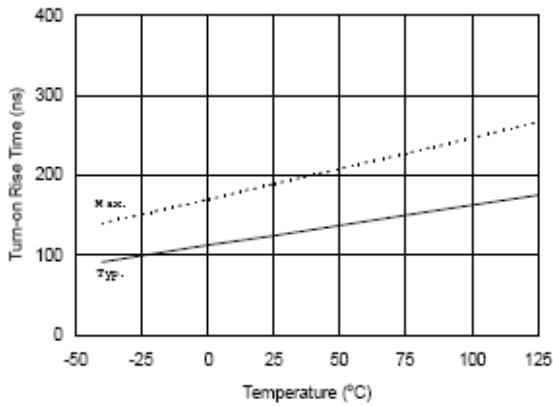

Figure 8A. Turn-on Rise Time vs. Temperature

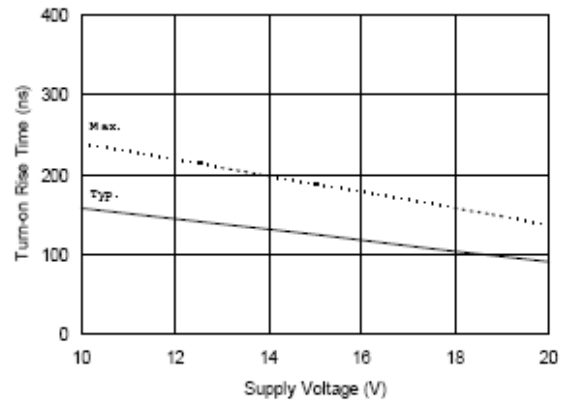

Figure 8B. Turn-on Rise Time vs. Supply Voltage



Figure 9A. Turn-off Fall Time vs. Temperature

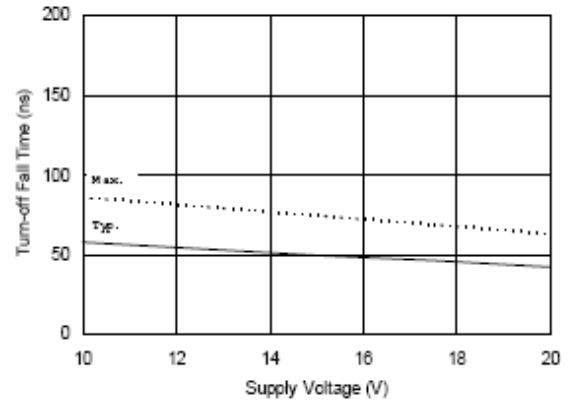

Figure 9B. Turn-off Fall Time vs. Supply Voltage

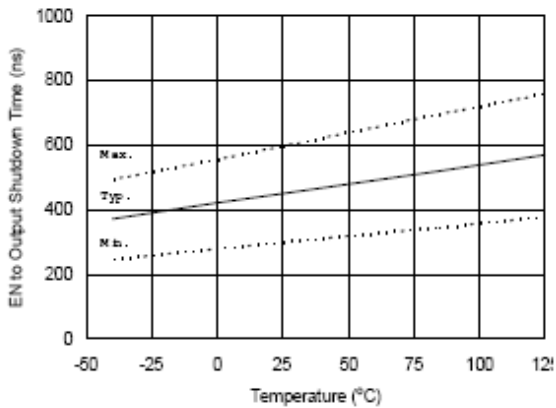

Figure 10A. EN to Output Shutdown Time vs. Temperature

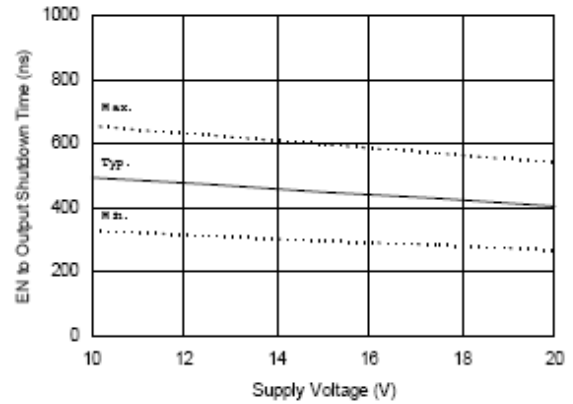

Figure 10B. EN to Output Shutdown Time vs. Supply Voltage

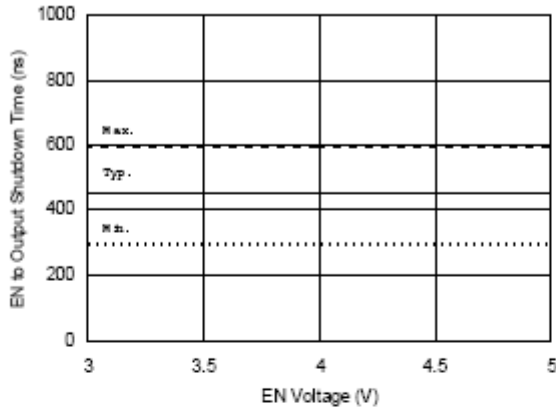

Figure 10C. EN to Output Shutdown Time vs. EN Voltage

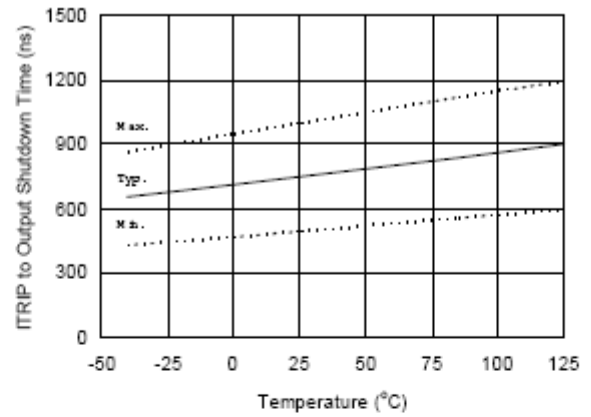

Figure 11A. ITRIP to Output Shutdown Time vs. Temperature

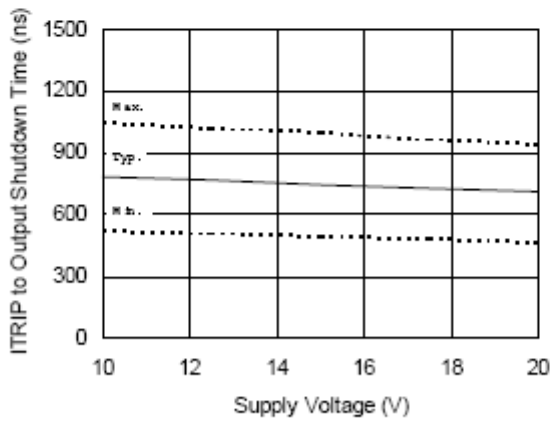

Figure 11B. ITRIP to Output Shutdown Time vs. Supply Voltage

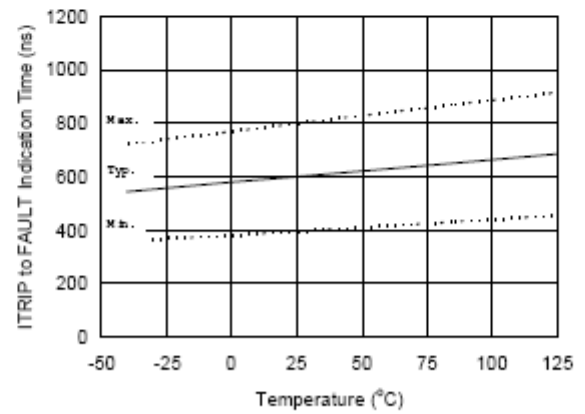

Figure 12A. ITRIP to FAULT Indication Time vs. Temperature

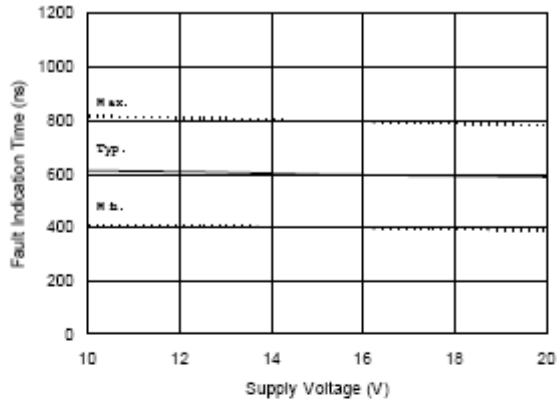

Figure 12B. ITRIP to FAULT Indication Time vs. Supply Voltage

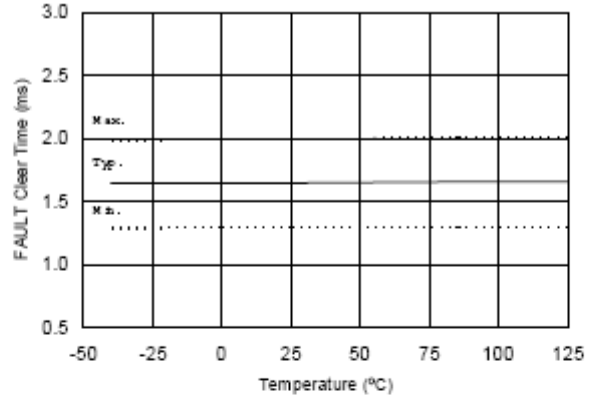

Fig13A. FAULT Clear Time vs. Temperature

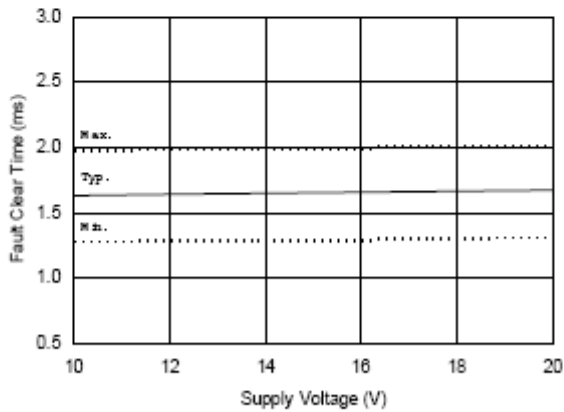

Figure 13B. FAULT Clear Time vs. Supply Voltage

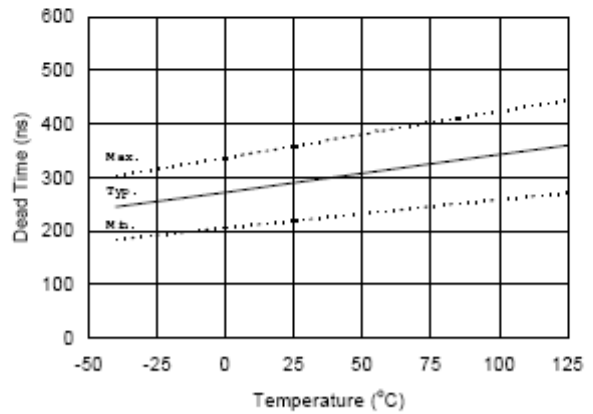

Figure 14A. Dead Time vs. Temperature

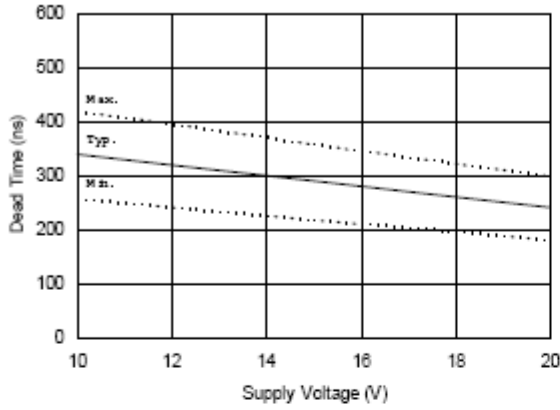

Figure 14B. Dead Time Time vs. Supply Voltage

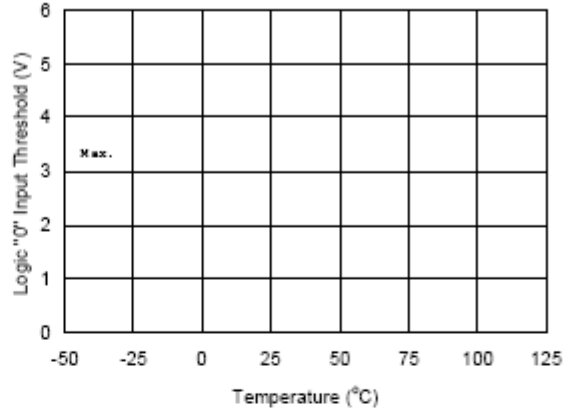

Figure 15A. Logic "0" Input Threshold vs. Temperature

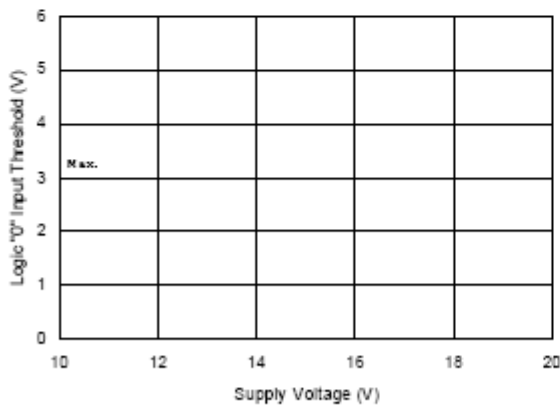

Figure 15B. Logic "0" Input Threshold vs. Supply Voltage

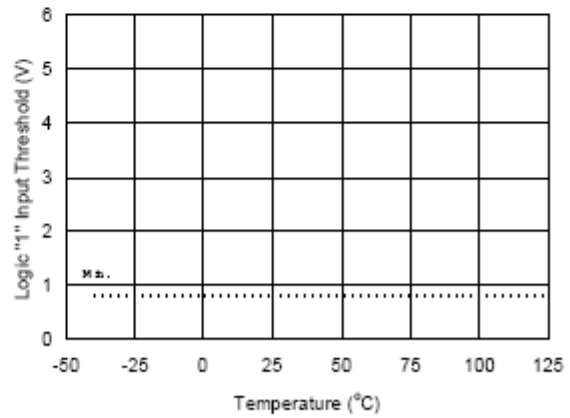

Figure 16A. Logic "1" Input Threshold vs. Temperature



Figure 16B. Logic "1" Input Threshold vs. Supply Voltage



Figure 17A. ITRIP Positive Going Threshold vs. Temperature (IR2136/21362/21363/IR21366 Only)



Figure 17B. ITRIP Positive Going Threshold vs. Supply Voltage (IR2136/21362/21363/IR21366 Only)

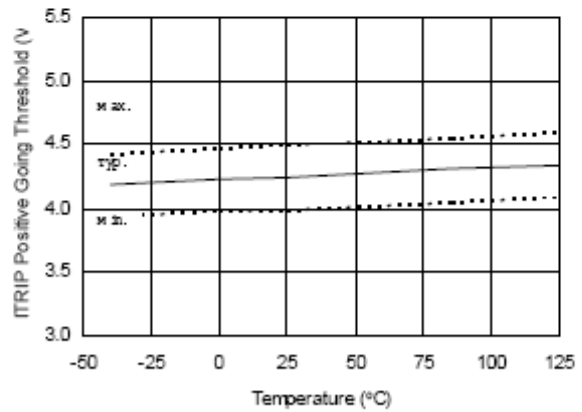

Figure 17C. ITRIP Positive Going Threshold vs. Temperature (IR21365/IR21367/IR21368 Only)

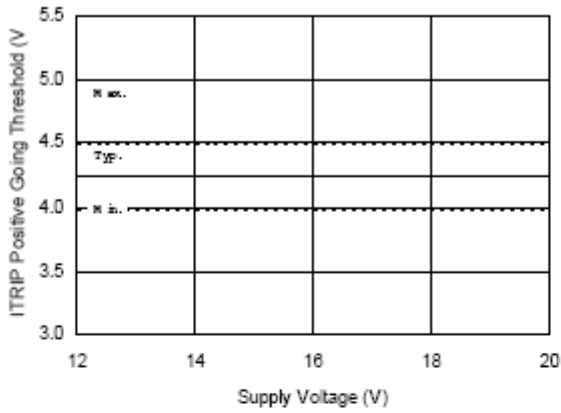

Figure 17D. ITRIP Positive Going Threshold vs. Supply Voltage (IR21365/IR21367/IR21368 Only)

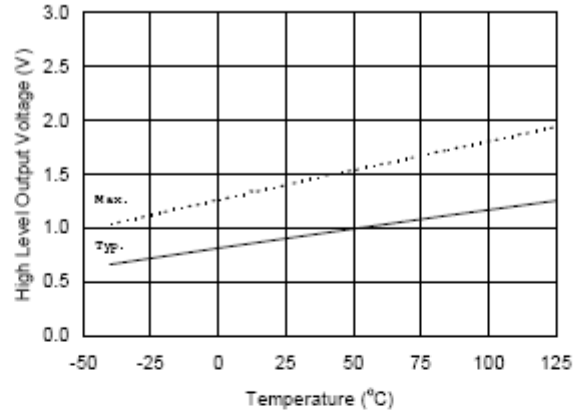

Figure 18A. High Level Output vs. Temperature

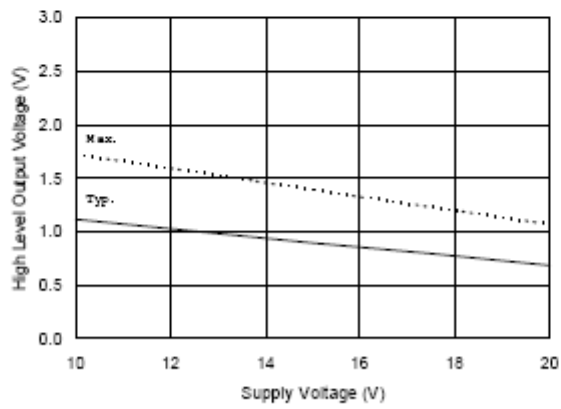

Figure 18B. High Level Output vs. Supply Voltage

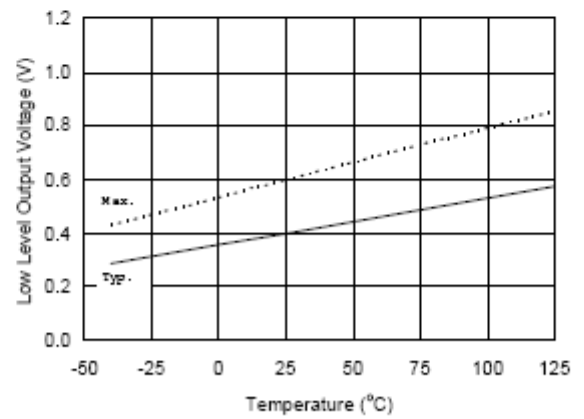

Figure 19A. Low Level Output vs. Temperature

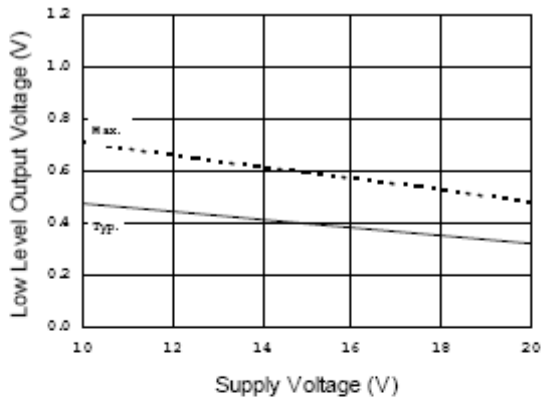

Figure 19B. Low Level Output vs. Supply Voltage



Figure 20. V_{CC} or V_{SS} Undervoltage Lockout (+) vs. Temperature (IR2136/IR21368 Only)

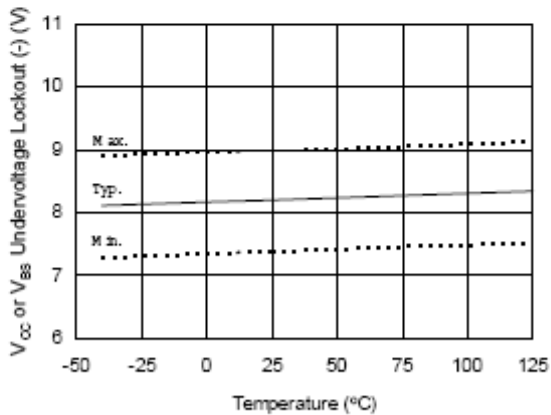

Figure 21. V_{CC} or V_{SS} Undervoltage Lockout (-) vs. Temperature (IR2136/IR21368 Only)

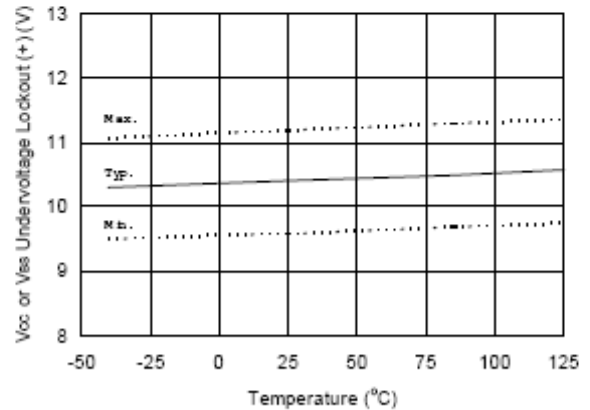

Figure 22. V_{CC} or V_{SS} Undervoltage Lockout (+) vs. Temperature (IR21362 Only)

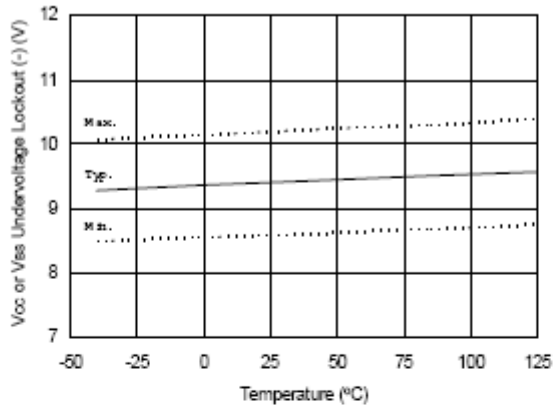

Figure 23. V_{CC} or V_{BS} Undervoltage Lockout (-) vs. Temperature (IR21362 Only)



Figure 24. V_{CC} or V_{BS} Undervoltage Lockout (+) vs. Temperature (IR21363/21365/IR21366/IR21367 Only)

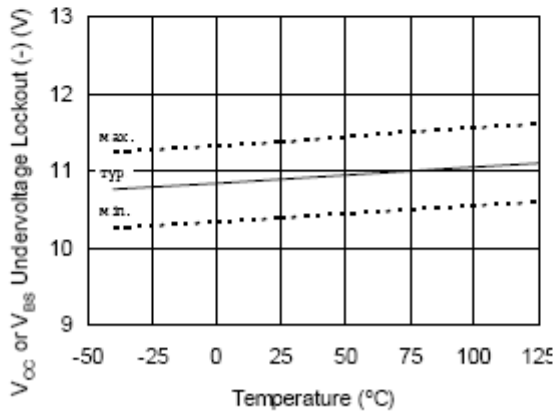

Figure 25. V_{CC} or V_{BS} Undervoltage Lockout (-) vs. Temperature (IR21363/21365/IR21366/IR21367 Only)

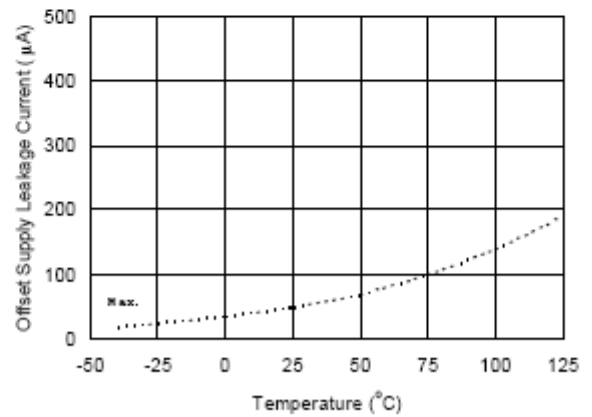

Figure 26A. Offset Supply Leakage Current vs. Temperature



Figure 26B. Offset Supply Leakage Current vs. V_B Boost Voltage



Figure 27A. V_{Bs} Supply Current vs. Temperature

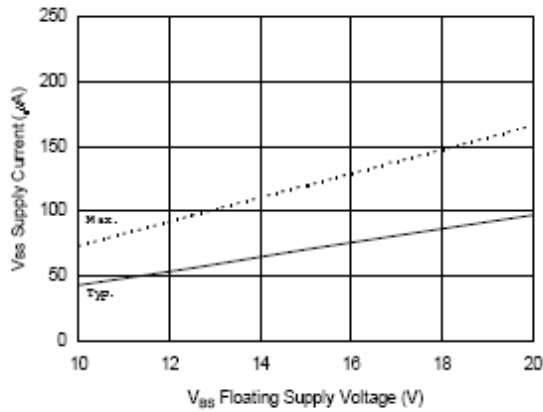

Figure 27B. V_{Bs} Supply Current vs. V_{Bs} Floating Supply Voltage

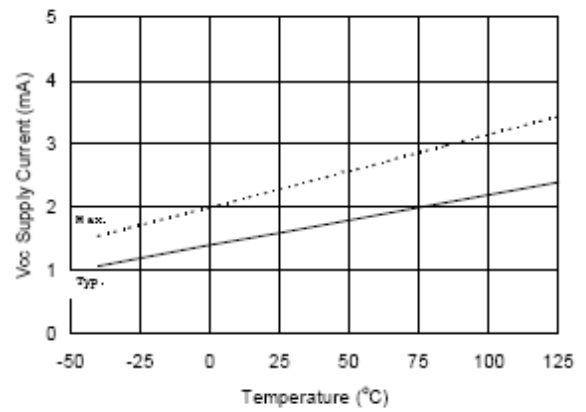

Figure 28A. V_{Cc} Supply Current vs. Temperature



Figure 28B. V_{CC} Supply Current vs. V_{CC} Supply Voltage

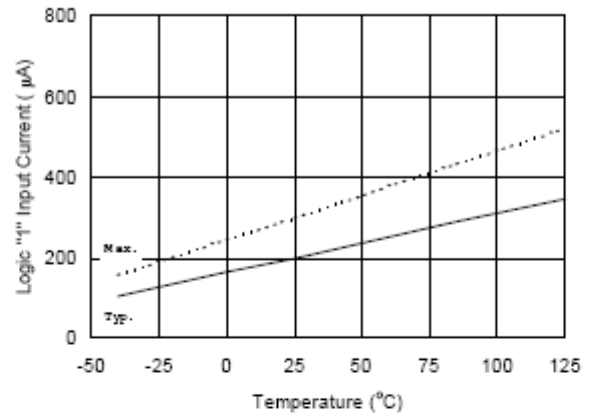

Figure 29A. Logic "1" Input Current vs. Temperature (IR2136/21363/21365 and IR21362 Low Side Only)



Figure 29B. Logic "1" Input Current vs. Supply Voltage (IR2136/21363/21365 and IR21362 Low Side Only)

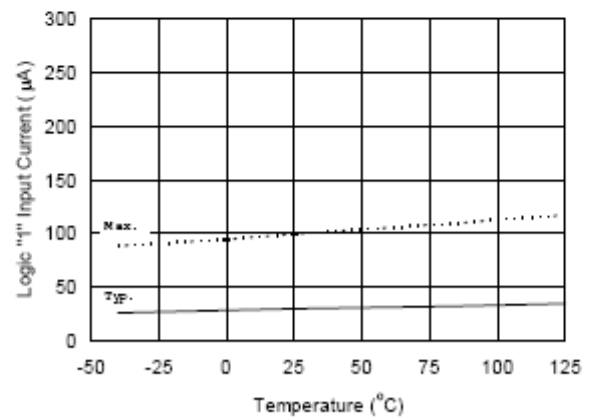

Figure 29C. Logic "1" Input Current vs. Temperature (IR21362 High Side Only)



Figure 29D. Logic "1" Input Current vs. Supply Voltage (IR21362 High Side Only)

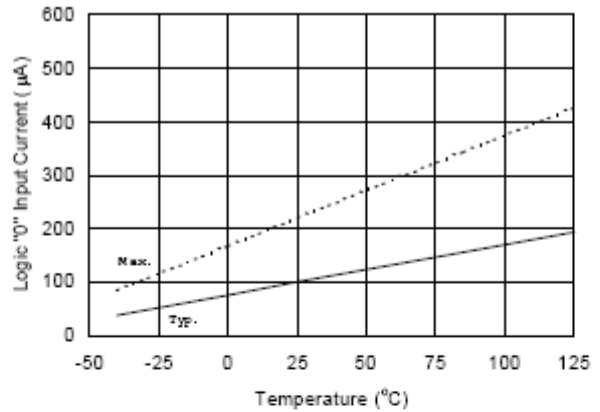

Figure 30A. Logic "0" Input Current vs. Temperature (IR2136/21363/21365 and IR21362 Low Side Only)

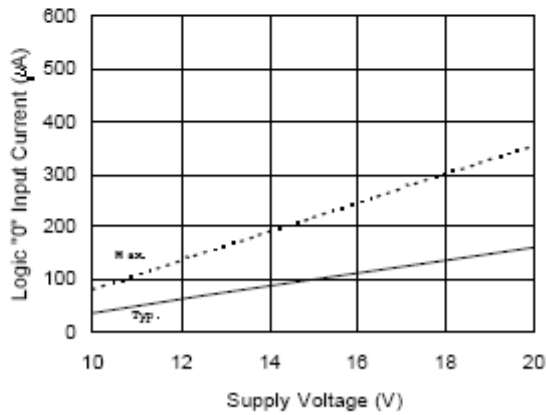

Figure 30B. Logic "0" Input Current vs. Supply Voltage (IR2136/21363/21365 and IR21362 Low Side Only)

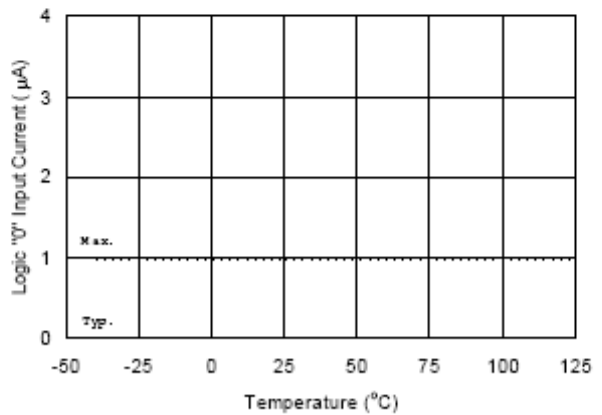

Figure 30C. Logic "0" Input Current vs. Temperature (IR21362 High Side Only)

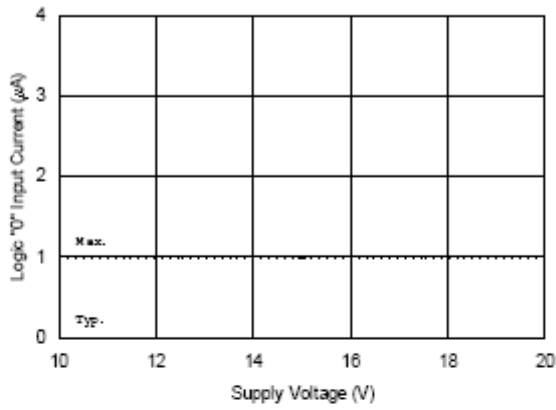

Figure 30D. Logic "0" Input Current vs. Supply Voltage (IR21362 High Side Only)



Figure 31A. "High" ITRIP Current vs. Temperature

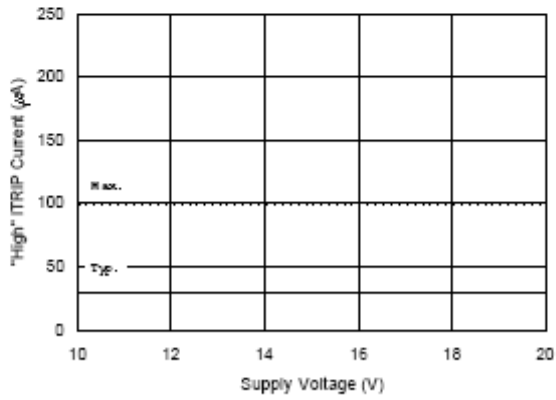

Figure 31B. "High" ITRIP Current vs. Supply Voltage

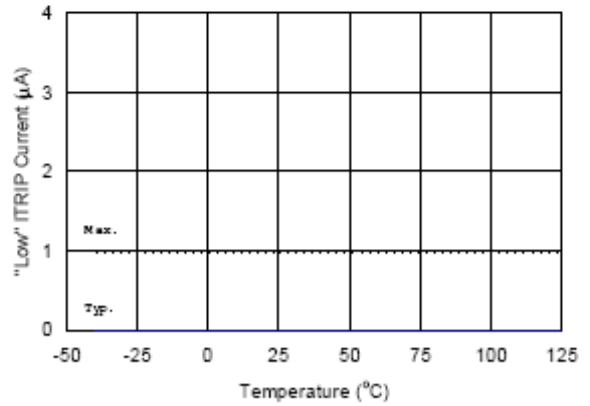

Figure 32A. "Low" ITRIP Current vs. Temperature

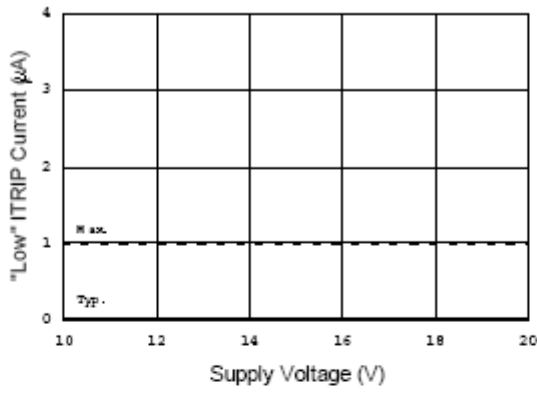

Figure 32B. "Low" ITRIP Current vs. Supply Voltage

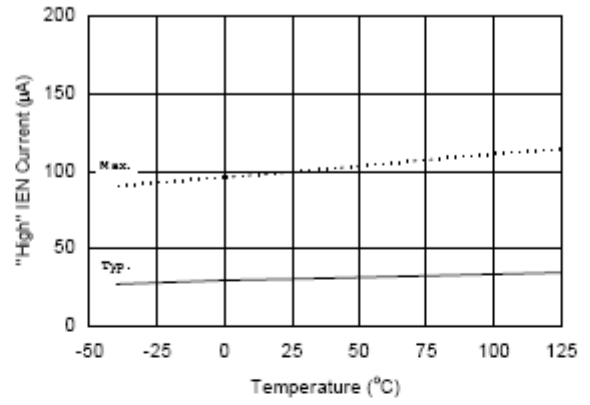

Figure 33A. "High" IEN Current vs. Temperature

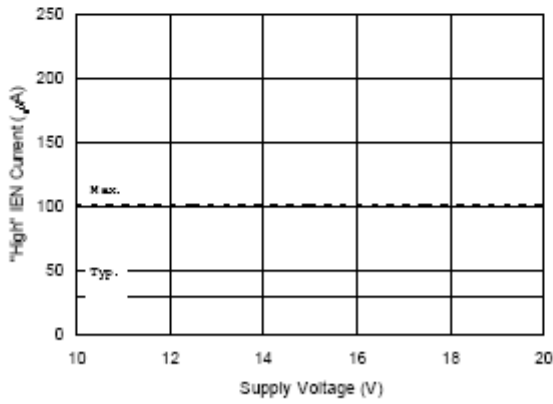

Figure 33B. "High" IEN Current vs. Supply Voltage

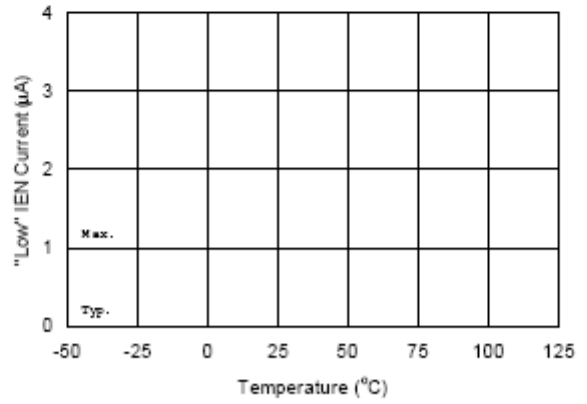

Figure 34A. "Low" IEN Current vs. Temperature

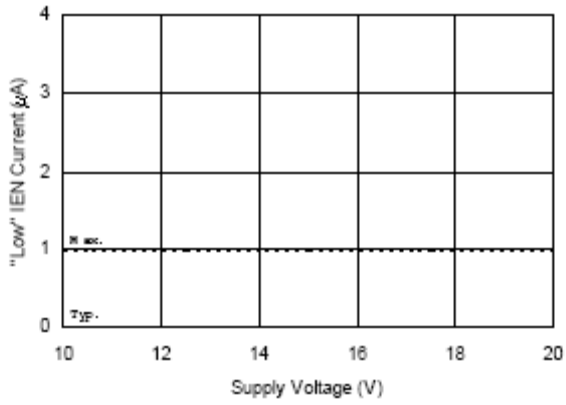

Figure 34B. "Low" IEN Current vs. Supply Voltage

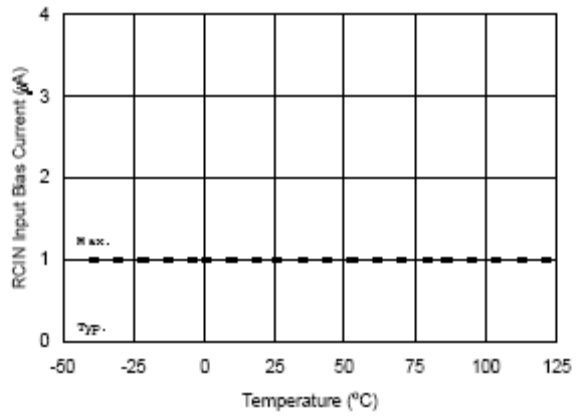

Figure 35A. RCIN Input Bias Current vs. Temperature

Figure 34B. "Low" IEN Current vs. Supply Voltage

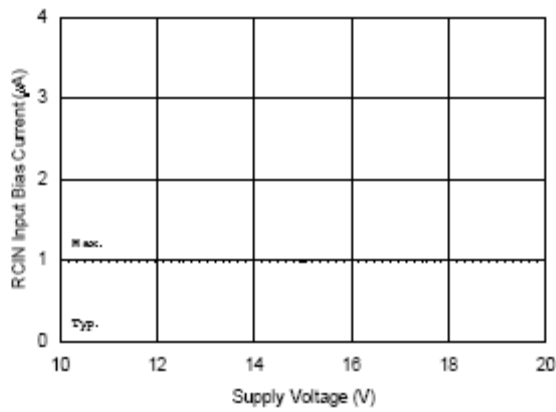

Figure 35B. RCIN Input Bias Current vs. Supply Voltage

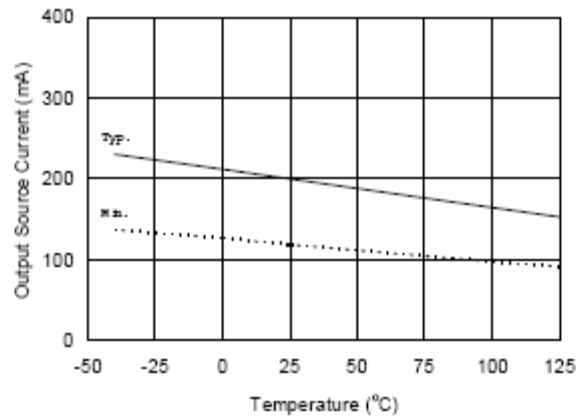

Figure 36A. Output Source Current vs. Temperature



Figure 36B. Output Source Current vs. Supply Voltage

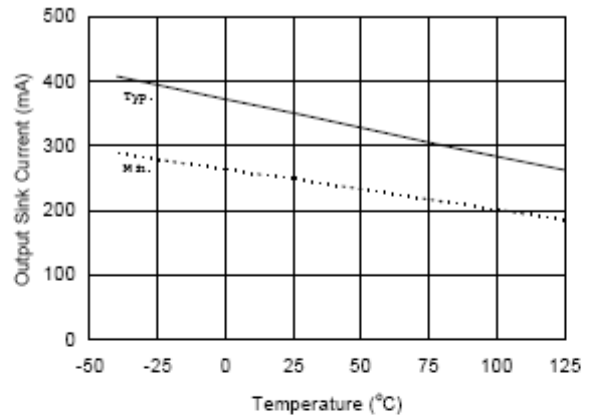

Figure 37A. Output Sink Current vs. Temperature

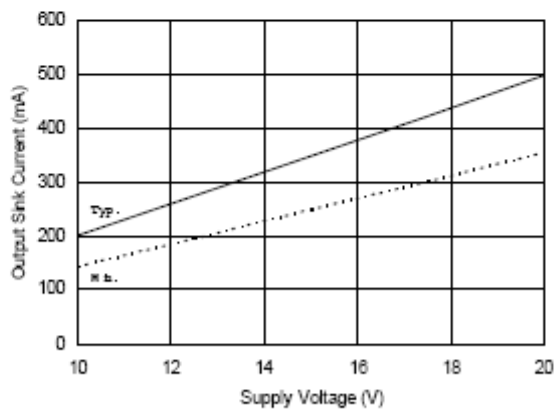

Figure 37B. Output Sink Current vs. Supply Voltage

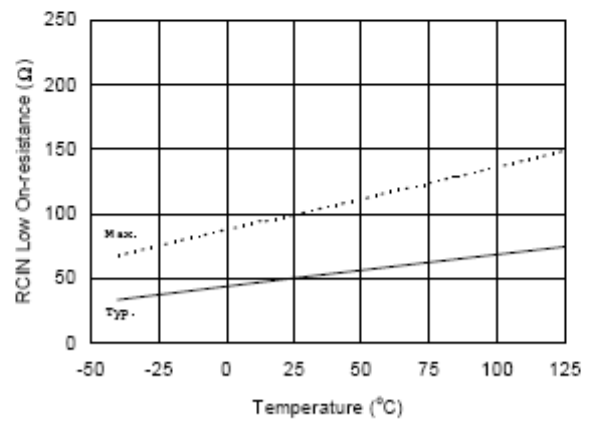

Figure 38A. RCIN Low On-resistance vs. Temperature

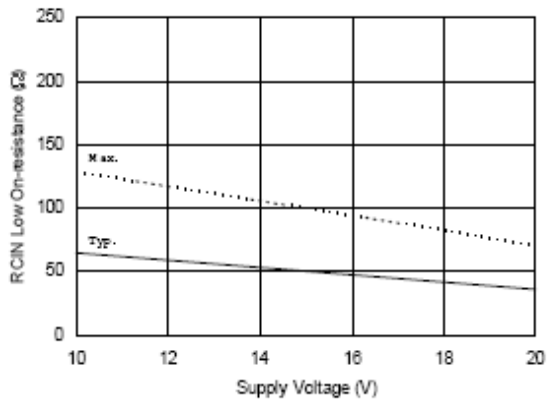

Figure 38B. RCIN Low On-resistance vs. Supply Voltage



Figure 39A. FAULT Low On-resistance vs. Temperature

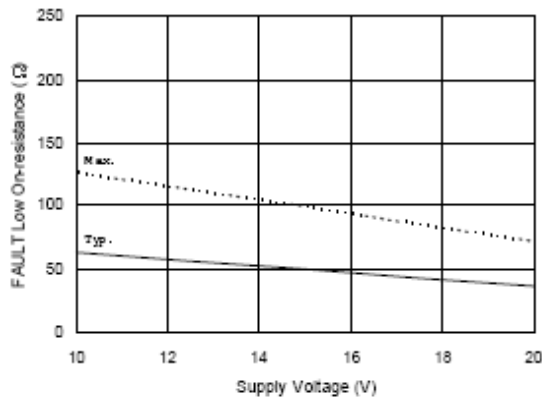

Figure 39B. FAULT Low On-resistance vs. Supply Voltage

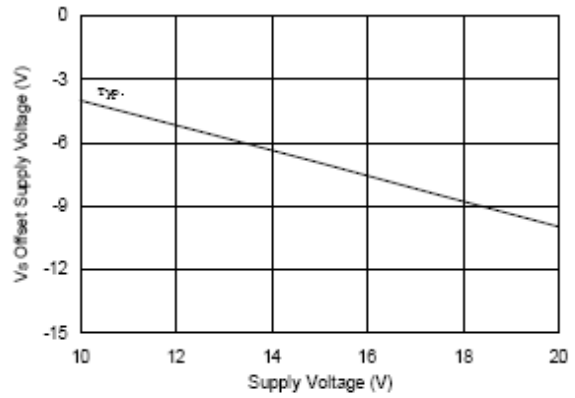

Figure 40. Maximum Vs Negative Offset vs. VDS



**Figure 41. IR2136/IR21362(3)(5)(6)(7)(8)
 vs. Frequency (IRG4BC20W), Rgate=33Ω, Vcc=15V**



**Figure 42. IR2136/IR21362(3)(5)(6)(7)(8)
 vs. Frequency (IRG4BC30W), Rgate=15Ω, Vcc=15V**



**Figure 43. IR2136/IR21362(3)(5)(6)(7)(8)
 vs. Frequency (IRG4BC40W), Rgate=10Ω, Vcc=15V**



**Figure 44. IR2136/IR21362(3)(5)(6)(7)(8)
 vs. Frequency (IRG4PC50W), Rgate=5Ω, Vcc=15V**



Figure 45. IR2136/IR21362(3)(5)(6)(7)(8) (J) vs. Frequency (IRG4BC20W), Rgate=33Ω, Vcc=15V

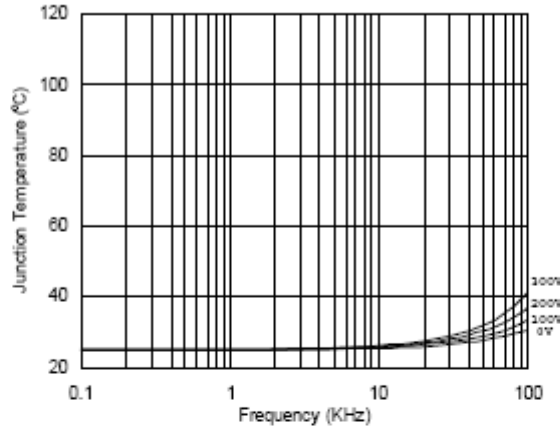

Figure 46. IR2136/IR21362(3)(5)(6)(7)(8) (J) vs. Frequency (IRG4BC30W), Rgate=15Ω, Vcc=15V

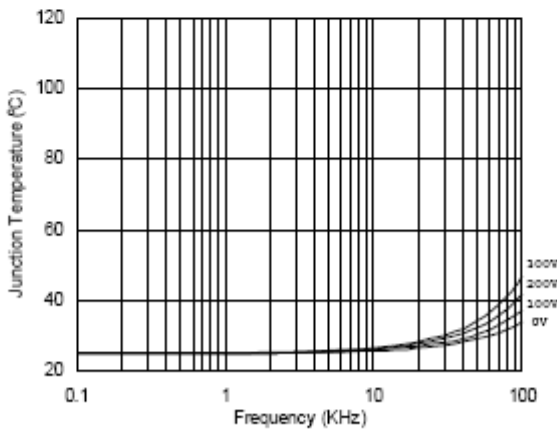

Figure 47. IR2136/IR21362(3)(5)(6)(7)(8) (J) vs. Frequency (IRG4BC40W), Rgate=10Ω, Vcc=15V

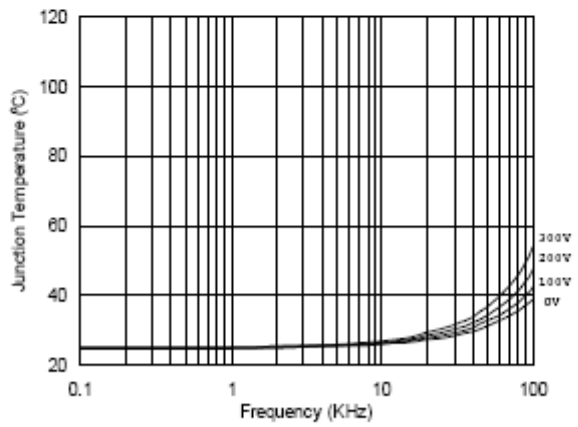

Figure 48. IR2136/IR21362(3)(5)(6)(7)(8) (J) vs. Frequency (IRG4PC50W), Rgate=5Ω, Vcc=15V

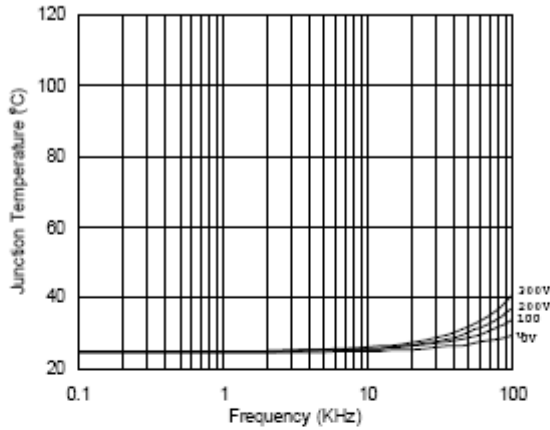

Figure 49. IR2136/IR21362(3)(5)(6)(7)(8) (S) vs. Frequency (IRG4BC20W), Rgate=33Ω, Vcc=15V

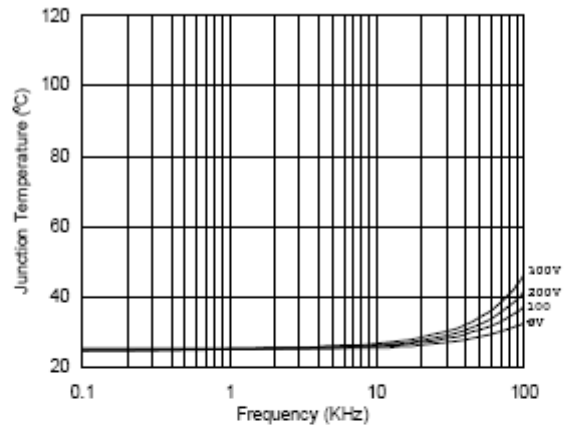

Figure 50. IR2136/IR21362(3)(5)(6)(7)(8) (S) vs. Frequency (IRG4BC30W), Rgate=15Ω, Vcc=15V

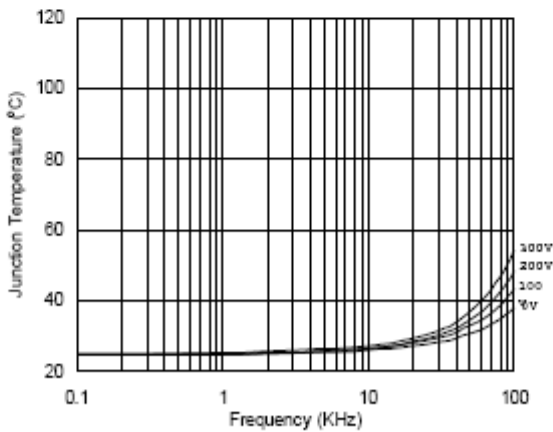

Figure 51. IR2136/IR21362(3)(5)(6)(7)(8) (S) vs. Frequency (IRG4BC40W), Rgate=10Ω, Vcc=15V

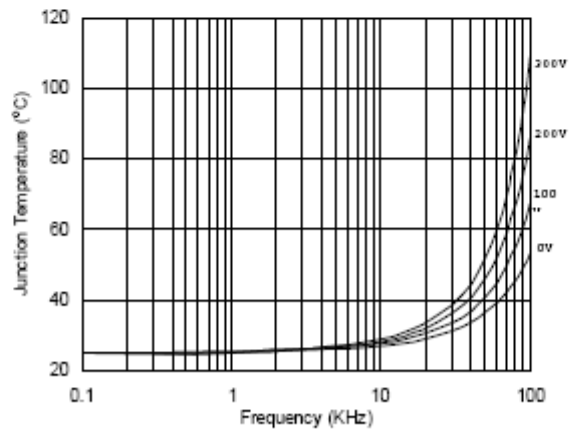
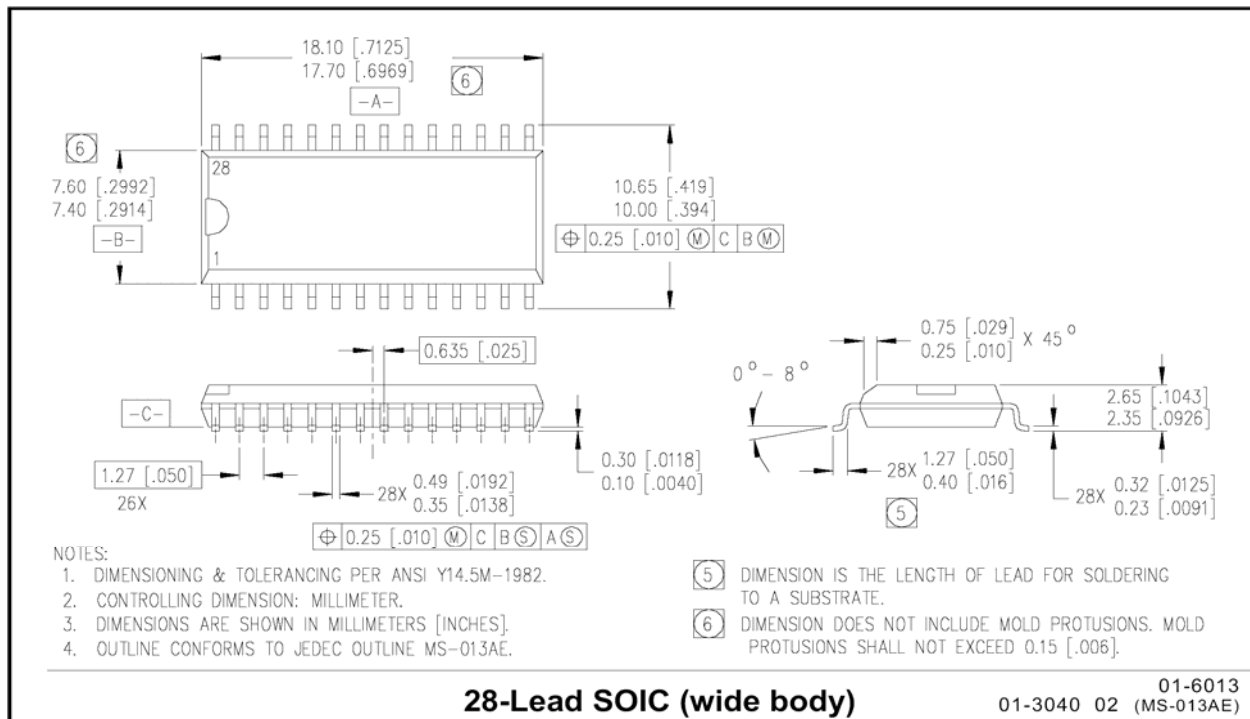
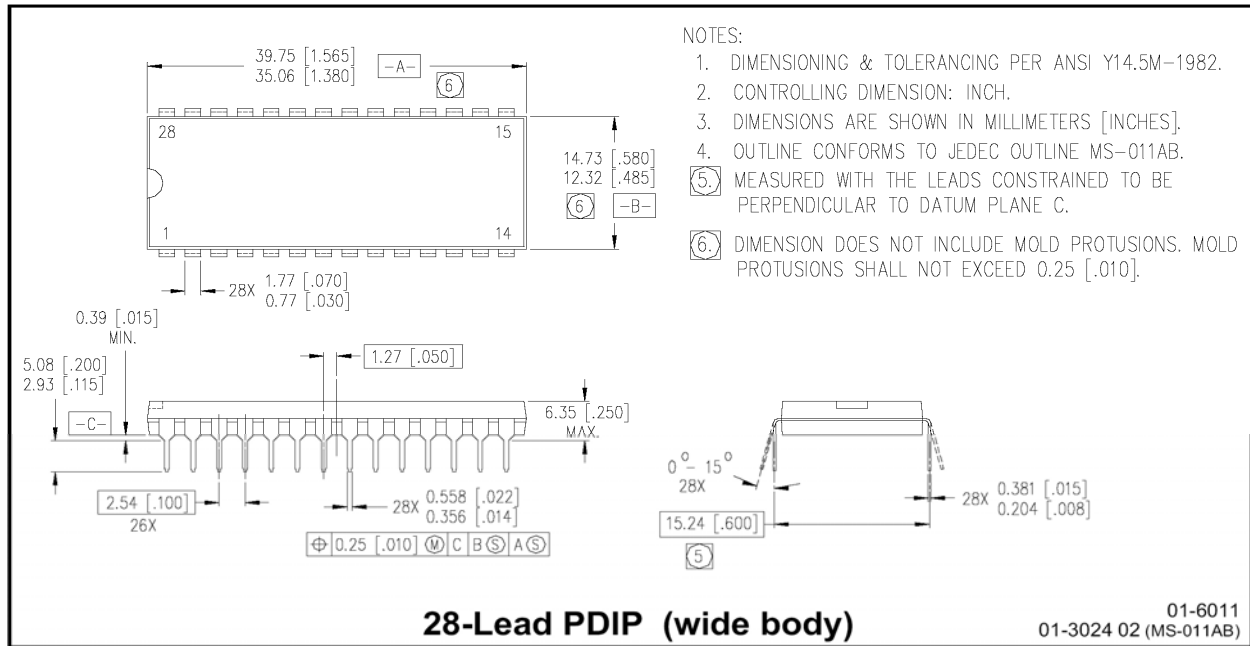

Figure 52. IR2136/IR21362(3)(5)(6)(7)(8) (S) vs. Frequency (IRG4PC50W), Rgate=5Ω, Vcc=15V

Case Outlines



Case Outlines

DIM	MILLIMETERS		INCHES	
	MIN	MAX	MIN	MAX
F	17.40	17.65	.685	.695
G	17.40	17.65	.685	.695
H	4.20	4.57	.165	.180
J	2.29	3.04	.090	.120
K	0.33	0.48	.013	.019
L	1.27	BSC	.050	BSC
M	0.66	0.81	.026	.032
N	0.51	—	.020	—
P	0.64	—	.025	—
R	16.51	16.66	.650	.656
S	16.51	16.66	.650	.656
T	1.07	1.21	.042	.048
V	—	0.50	—	.020
W	5.08	BSC	.200	BSC
L1	15.50	16.00	.610	.630
P1	1.53	—	.060	—

NOTES

- DIMENSIONING & TOLERENCING PER ANSI Y14.5M-1982.
- DIMENSIONS SHOWN IN MILLIMETERS [INCHES].
- CONTROLLING DIMENSION: INCH.
- CONFORMS TO JEDEC OUTLINE MS-018AC.
- DATUMS -A-, -B-, -C-, & -D- ARE DETERMINED BY WHERE THE TOP OF THE LEADS EXIT PLASTIC BODY AT MOLD PARTING LINE.

⑥ TO BE MEASURED AT -E- SEATING PLANE.
⑦ DIMENSIONS DO NOT INCLUDE MOLD FLASH, ALLOWABLE FLASH IS 0.254 [.010].

44-Lead PLCC w/o 12 leads

01-6009 00
01-3004 02(mod.) (MS-018AC)

LEAD-FREE PART MARKING INFORMATION

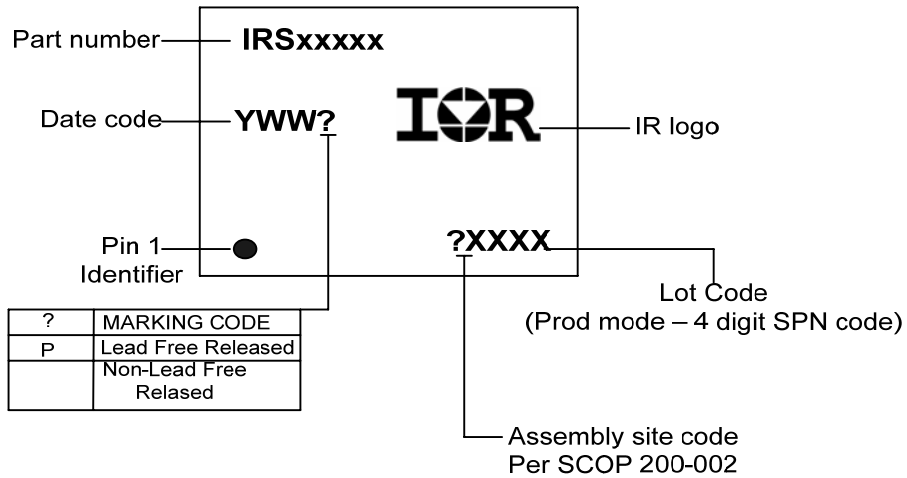

ORDER INFORMATION

Basic Part

28-Lead PDIP IR2136(3,5,6,7,8)
 28-Lead SOIC IR2136(3,5,6,7,8)S
 44-Lead PLCC IR2136(3,5,6,7,8)J
 28-Lead PDIP IR21362
 28-Lead SOIC IR21362S
 44-Lead PLCC IR21362J

Order IR2136(3,5,6,7,8)
 Order IR2136(3,5,6,7,8)S
 Order IR2136(3,5,6,7,8)J
 Order IR21362
 Order IR21362S
 Order IR21362J

Lead-Free Part

28-Lead PDIP IR2136(3,5,6,7,8)
 28-Lead SOIC IR2136(3,5,6,7,8)S
 44-Lead PLCC IR2136(3,5,6,7,8)J
 28-Lead PDIP IR21362
 28-Lead SOIC IR21362S
 44-Lead PLCC IR21362J

Order IR2136(3,5,6,7,8)PbF
 Order IR2136(3,5,6,7,8)(S)PbF
 Order IR2136(3,5,6,7,8)(J)PbF
 Order IR21362PbF
 Order IR21362SPbF
 Order IR21362JPbF