

## FEATURES

- Member of the Texas Instruments Widebus™ Family
- EPIC™ (Enhanced-Performance Implanted CMOS) Submicron Process
- Designed to Comply With JEDEC 168-Pin and 200-Pin SDRAM Buffered DIMM Specification
- ESD Protection Exceeds 2000 V Per MIL-STD-883, Method 3015; Exceeds 200 V Using Machine Model (C = 200 pF, R = 0)
- Latch-Up Performance Exceeds 250 mA Per JESD 17
- Bus Hold on Data Inputs Eliminates the Need for External Pullup/Pulldown Resistors
- Package Options Include Plastic Shrink Small-Outline (DL), Thin Shrink Small-Outline (DGG), and Thin Very Small-Outline (DGV) Packages

## DESCRIPTION

This 16-bit universal bus driver is designed for 1.65-V to 3.6-V  $V_{CC}$  operation.

Data flow from A to Y is controlled by the output-enable ( $\overline{OE}$ ) input. The device operates in the transparent mode when the latch-enable ( $\overline{LE}$ ) input is low. When  $\overline{LE}$  is high, the A data is latched if the clock (CLK) input is held at a high or low logic level. If  $\overline{LE}$  is high, the A data is stored in the latch/flip-flop on the low-to-high transition of CLK. When  $\overline{OE}$  is high, the outputs are in the high-impedance state.

To ensure the high-impedance state during power up or power down,  $\overline{OE}$  should be tied to  $V_{CC}$  through a pullup resistor; the minimum value of the resistor is determined by the current-sinking capability of the driver.

Active bus-hold circuitry is provided to hold unused or floating data inputs at a valid logic level.

The SN74ALVCH16334 is characterized for operation from -40°C to 85°C.

DGG, DGV, OR DL PACKAGE  
(TOP VIEW)

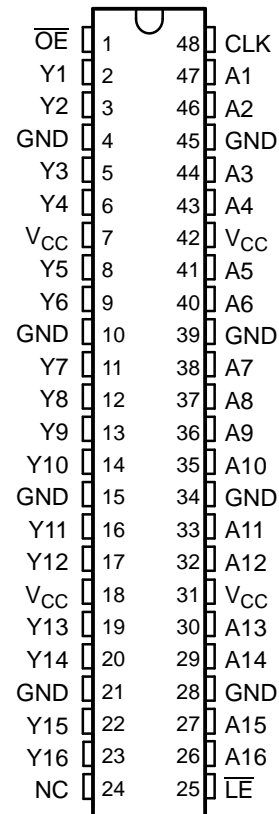

NC – No internal connection

## FUNCTION TABLE

INPUTS				OUTPUT
$\overline{OE}$	$\overline{LE}$	CLK	A	Y
H	X	X	X	Z
L	L	X	L	L
L	L	X	H	H
L	H	↑	L	L
L	H	↑	H	H
L	H	L or H	X	$Y_0^{(1)}$

(1) Output level before the indicated steady-state input conditions were established



Please be aware that an important notice concerning availability, standard warranty, and use in critical applications of Texas Instruments semiconductor products and disclaimers thereto appears at the end of this data sheet.

Widebus, EPIC are trademarks of Texas Instruments.

**SN74ALVCH16334**  
**16-BIT UNIVERSAL BUS DRIVER**  
**WITH 3-STATE OUTPUTS**

SCES090I—OCTOBER 1996—REVISED SEPTEMBER 2004

**LOGIC SYMBOL<sup>(1)</sup>**

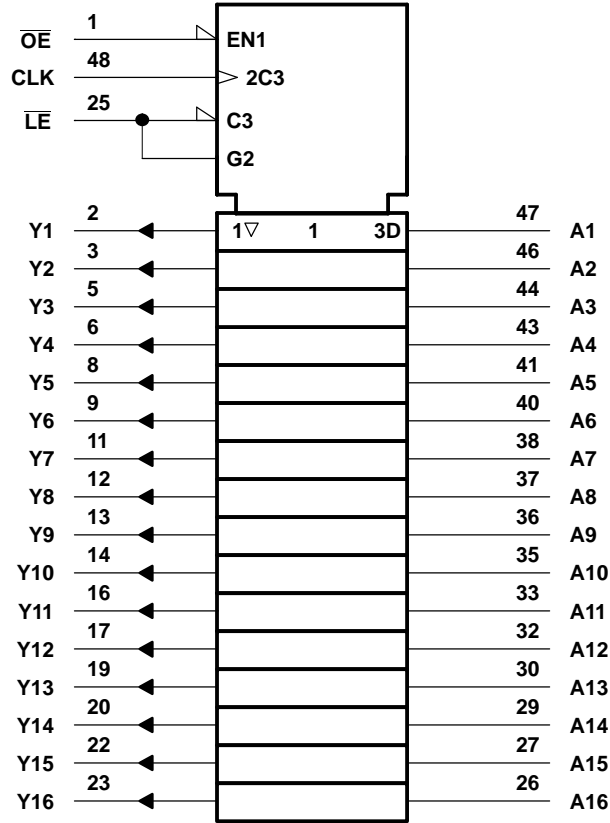

(1) This symbol is in accordance with ANSI/IEEE Std 91-1984 and IEC Publication 617-12.

**LOGIC DIAGRAM (POSITIVE LOGIC)**

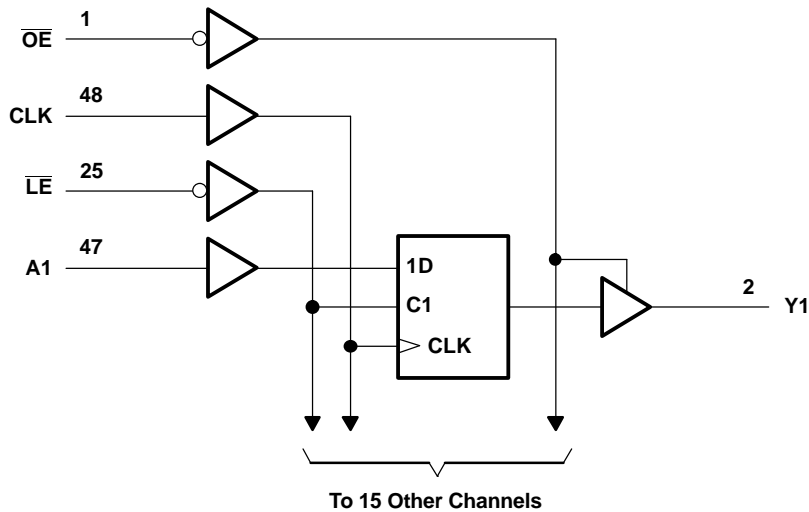

**ABSOLUTE MAXIMUM RATINGS<sup>(1)</sup>**

over operating free-air temperature range (unless otherwise noted)

		MIN	MAX	UNIT
V <sub>CC</sub>	Supply voltage range	-0.5	4.6	V
V <sub>I</sub>	Input voltage range <sup>(2)</sup>	-0.5	4.6	V
V <sub>O</sub>	Output voltage range <sup>(2)(3)</sup>	-0.5	V <sub>CC</sub> + 0.5	V
I <sub>IK</sub>	Input clamp current	V <sub>I</sub> < 0		-50 mA
I <sub>OK</sub>	Output clamp current	V <sub>O</sub> < 0		-50 mA
I <sub>O</sub>	Continuous output current			±50 mA
Continuous current through each V <sub>CC</sub> or GND				±100 mA
θ <sub>JA</sub>	Package thermal impedance <sup>(4)</sup>	DGG package		89 °C/W
		DGV package		93
		DL package		94
T <sub>stg</sub>	Storage temperature range	-65	150	°C

- (1) Stresses beyond those listed under "absolute maximum ratings" may cause permanent damage to the device. These are stress ratings only, and functional operation of the device at these or any other conditions beyond those indicated under "recommended operating conditions" is not implied. Exposure to absolute-maximum-rated conditions for extended periods may affect device reliability.
- (2) The input negative-voltage and output voltage ratings may be exceeded if the input and output current ratings are observed.
- (3) This value is limited to 4.6 V maximum.
- (4) The package thermal impedance is calculated in accordance with JESD 51.

**SN74ALVCH16334**  
**16-BIT UNIVERSAL BUS DRIVER**  
**WITH 3-STATE OUTPUTS**

SCES090I—OCTOBER 1996—REVISED SEPTEMBER 2004

**RECOMMENDED OPERATING CONDITIONS<sup>(1)</sup>**

		MIN	MAX	UNIT
V <sub>CC</sub>	Supply voltage	1.65	3.6	V
V <sub>IH</sub>	High-level input voltage	V <sub>CC</sub> = 1.65 V to 1.95 V	0.65 × V <sub>CC</sub>	V
		V <sub>CC</sub> = 2.3 V to 2.7 V	1.7	
		V <sub>CC</sub> = 2.7 V to 3.6 V	2	
V <sub>IL</sub>	Low-level input voltage	V <sub>CC</sub> = 1.65 V to 1.95 V	0.35 × V <sub>CC</sub>	V
		V <sub>CC</sub> = 2.3 V to 2.7 V	0.7	
		V <sub>CC</sub> = 2.7 V to 3.6 V	0.8	
V <sub>I</sub>	Input voltage	0	V <sub>CC</sub>	V
V <sub>O</sub>	Output voltage	0	V <sub>CC</sub>	V
I <sub>OH</sub>	High-level output current	V <sub>CC</sub> = 1.65 V	-4	mA
		V <sub>CC</sub> = 2.3 V	-12	
		V <sub>CC</sub> = 2.7 V	-12	
		V <sub>CC</sub> = 3 V	-24	
I <sub>OL</sub>	Low-level output current	V <sub>CC</sub> = 1.65 V	4	mA
		V <sub>CC</sub> = 2.3 V	12	
		V <sub>CC</sub> = 2.7 V	12	
		V <sub>CC</sub> = 3 V	24	
Δt/Δv	Input transition rise or fall rate		10	ns/V
T <sub>A</sub>	Operating free-air temperature	-40	85	°C

(1) All unused control inputs of the device must be held at V<sub>CC</sub> or GND to ensure proper device operation. Refer to the TI application report, *Implications of Slow or Floating CMOS Inputs*, literature number SCBA004.

## ELECTRICAL CHARACTERISTICS

over recommended operating free-air temperature range (unless otherwise noted)

PARAMETER		TEST CONDITIONS	V <sub>CC</sub>	MIN	TYP <sup>(1)</sup>	MAX	UNIT
V <sub>OH</sub>		I <sub>OH</sub> = -100 μA	1.65 V to 3.6 V	V <sub>CC</sub> - 0.2			V
		I <sub>OH</sub> = -4 mA	1.65 V	1.2			
		I <sub>OH</sub> = -6 mA	2.3 V	2			
		I <sub>OH</sub> = -12 mA	2.3 V	1.7			
			2.7 V	2.2			
			3 V	2.4			
	I <sub>OH</sub> = -24 mA	3 V	2				
V <sub>OL</sub>		I <sub>OL</sub> = 100 μA	1.65 V to 3.6 V			0.2	V
		I <sub>OL</sub> = 4 mA	1.65 V			0.45	
		I <sub>OL</sub> = 6 mA	2.3 V			0.4	
		I <sub>OL</sub> = 12 mA	2.3 V			0.7	
			2.7 V			0.4	
		I <sub>OL</sub> = 24 mA	3 V			0.55	
I <sub>I</sub>		V <sub>I</sub> = V <sub>CC</sub> or GND	3.6 V			±5	μA
I <sub>I(hold)</sub>		V <sub>I</sub> = 0.58 V	1.65 V	25			μA
		V <sub>I</sub> = 1.07 V	1.65 V	-25			
		V <sub>I</sub> = 0.7 V	2.3 V	45			
		V <sub>I</sub> = 1.7 V	2.3 V	-45			
		V <sub>I</sub> = 0.8 V	3 V	75			
		V <sub>I</sub> = 2 V	3 V	-75			
		V <sub>I</sub> = 0 to 3.6 V <sup>(2)</sup>	3.6 V			±500	
I <sub>OZ</sub>		V <sub>O</sub> = V <sub>CC</sub> or GND	3.6 V			±10	μA
I <sub>CC</sub>		V <sub>I</sub> = V <sub>CC</sub> or GND, I <sub>O</sub> = 0	3.6 V			40	μA
ΔI <sub>CC</sub>		One input at V <sub>CC</sub> - 0.6 V, Other inputs at V <sub>CC</sub> or GND	3 V to 3.6 V			750	μA
C <sub>i</sub>	Control inputs	V <sub>I</sub> = V <sub>CC</sub> or GND	3.3 V	5.5			pF
	Data inputs			6			
C <sub>o</sub>	Outputs	V <sub>O</sub> = V <sub>CC</sub> or GND	3.3 V	8			pF

(1) All typical values are at V<sub>CC</sub> = 3.3 V, T<sub>A</sub> = 25°C.

(2) This is the bus-hold maximum dynamic current. It is the minimum overdrive current required to switch the input from one state to another.

## TIMING REQUIREMENTS

over recommended operating free-air temperature range (unless otherwise noted) (see Figure 1 through Figure 3)

		V <sub>CC</sub> = 1.8 V		V <sub>CC</sub> = 2.5 V ± 0.2 V		V <sub>CC</sub> = 2.7 V		V <sub>CC</sub> = 3.3 V ± 0.3 V		UNIT	
		MIN	MAX	MIN	MAX	MIN	MAX	MIN	MAX		
f <sub>clock</sub>	Clock frequency	(1)		150		150		150		MHz	
t <sub>w</sub>	Pulse duration	LE low		(1)		3.3		3.3		ns	
		CLK high or low		(1)		3.3		3.3			
t <sub>su</sub>	Setup time	Data before CLK↑		(1)		1.4		1.7		ns	
		Data before LE↑	CLK high		(1)		1.2		1.6		
			CLK low		(1)		1.4		1.5		
t <sub>h</sub>	Hold time	Data after CLK↑		(1)		0.9		0.8		ns	
		Data after LE↑	CLK high or low		(1)		1.2		1.1		

(1) This information was not available at the time of publication.

**SN74ALVCH16334**  
**16-BIT UNIVERSAL BUS DRIVER**  
**WITH 3-STATE OUTPUTS**

SCES090I—OCTOBER 1996—REVISED SEPTEMBER 2004

**SWITCHING CHARACTERISTICS**

over recommended operating free-air temperature range (unless otherwise noted) (see Figure 1 through Figure 3)

PARAMETER	FROM (INPUT)	TO (OUTPUT)	V <sub>CC</sub> = 1.8 V		V <sub>CC</sub> = 2.5 V ± 0.2 V		V <sub>CC</sub> = 2.7 V		V <sub>CC</sub> = 3.3 V ± 0.3 V		UNIT
			MIN	TYP	MIN	MAX	MIN	MAX	MIN	MAX	
f <sub>max</sub>			(1)		150		150		150		MHz
t <sub>pd</sub>	A	Y		(1)	1	3.7		3.6	1.1	3.3	ns
	$\overline{LE}$		(1)	1	4.8		5	1.3	4.4		
	CLK		(1)	1	4.4		4.5	1	4.1		
t <sub>en</sub>	$\overline{OE}$	Y		(1)	1	5.4		5.4	1.1	4.6	ns
t <sub>dis</sub>	$\overline{OE}$	Y		(1)	1	4.1		4.5	1.7	4.4	ns

(1) This information was not available at the time of publication.

**OPERATING CHARACTERISTICS**

T<sub>A</sub> = 25°C

PARAMETER		TEST CONDITIONS	V <sub>CC</sub> = 1.8 V	V <sub>CC</sub> = 2.5 V	V <sub>CC</sub> = 3.3 V	UNIT
			TYP	TYP	TYP	
C <sub>pd</sub> Power dissipation capacitance	Outputs enabled	C <sub>L</sub> = 0, f = 10 MHz	(1)	32	37	pF
	Outputs disabled		(1)	7	11	

(1) This information was not available at the time of publication.

PARAMETER MEASUREMENT INFORMATION

$V_{CC} = 1.8\text{ V}$

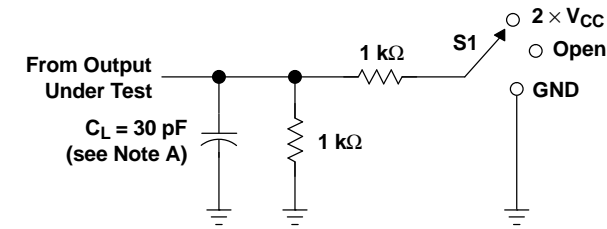

LOAD CIRCUIT

TEST	S1
$t_{pd}$	Open
$t_{PLZ}/t_{PZL}$	2 $\times V_{CC}$
$t_{PHZ}/t_{PZH}$	GND

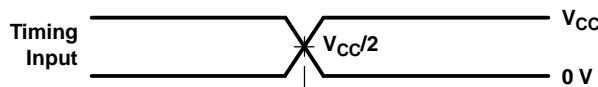

VOLTAGE WAVEFORMS  
PULSE DURATION

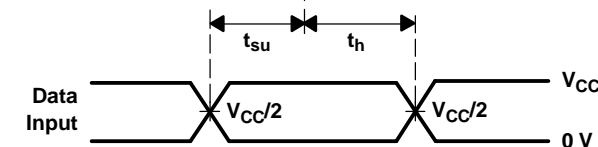

VOLTAGE WAVEFORMS  
SETUP AND HOLD TIMES

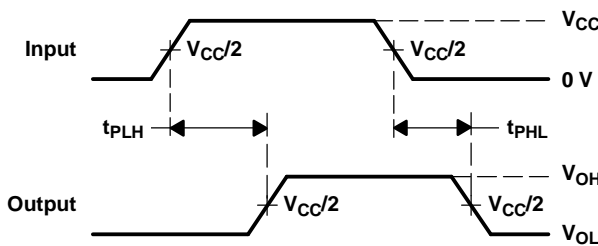
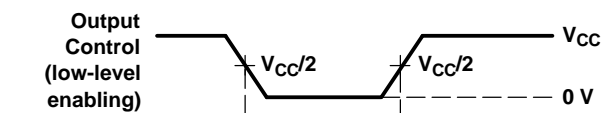

VOLTAGE WAVEFORMS  
PROPAGATION DELAY TIMES

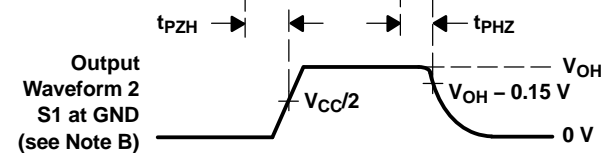
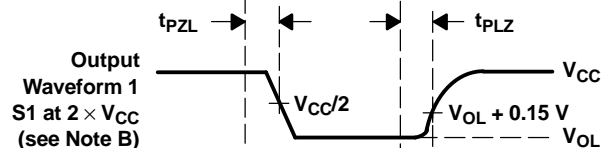

VOLTAGE WAVEFORMS  
ENABLE AND DISABLE TIMES

- NOTES:
- $C_L$  includes probe and jig capacitance.
  - Waveform 1 is for an output with internal conditions such that the output is low, except when disabled by the output control. Waveform 2 is for an output with internal conditions such that the output is high, except when disabled by the output control.
  - All input pulses are supplied by generators having the following characteristics:  $PRR \leq 10\text{ MHz}$ ,  $Z_O = 50\ \Omega$ ,  $t_r \leq 2\text{ ns}$ ,  $t_f \leq 2\text{ ns}$ .
  - The outputs are measured one at a time, with one transition per measurement.
  - $t_{PLZ}$  and  $t_{PHZ}$  are the same as  $t_{dis}$ .
  - $t_{PZL}$  and  $t_{PZH}$  are the same as  $t_{en}$ .
  - $t_{PLH}$  and  $t_{PHL}$  are the same as  $t_{pd}$ .

Figure 1. Load Circuit and Voltage Waveforms

**PARAMETER MEASUREMENT INFORMATION**

$V_{CC} = 2.5\text{ V} \pm 0.2\text{ V}$

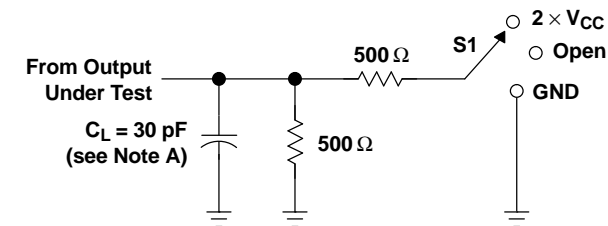

**LOAD CIRCUIT**

TEST	S1
$t_{pd}$	Open
$t_{PLZ}/t_{PZL}$	2 $\times V_{CC}$
$t_{PHZ}/t_{PZH}$	GND

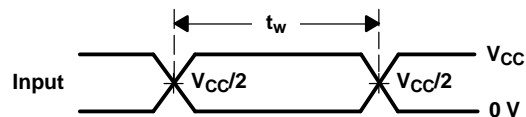
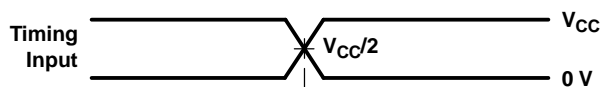

**VOLTAGE WAVEFORMS**  
**PULSE DURATION**

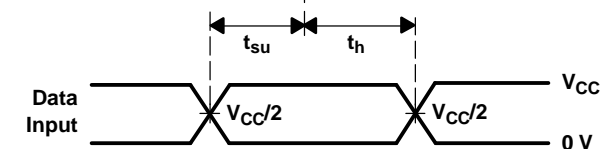

**VOLTAGE WAVEFORMS**  
**SETUP AND HOLD TIMES**

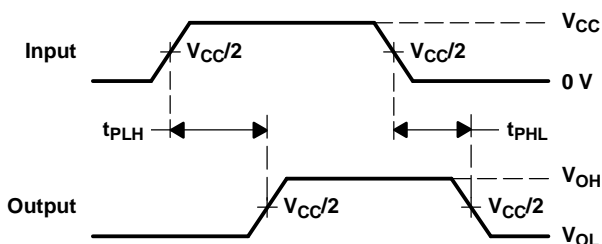
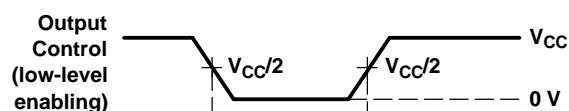

**VOLTAGE WAVEFORMS**  
**PROPAGATION DELAY TIMES**

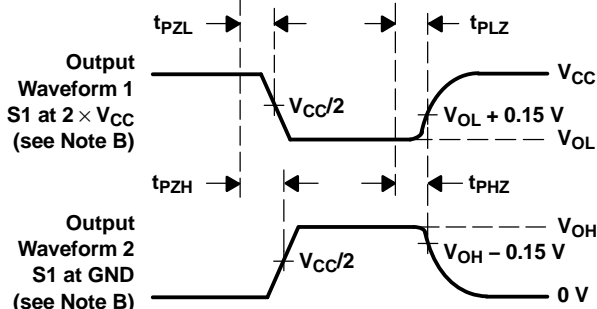

**VOLTAGE WAVEFORMS**  
**ENABLE AND DISABLE TIMES**

- NOTES: A.  $C_L$  includes probe and jig capacitance.  
B. Waveform 1 is for an output with internal conditions such that the output is low, except when disabled by the output control. Waveform 2 is for an output with internal conditions such that the output is high, except when disabled by the output control.  
C. All input pulses are supplied by generators having the following characteristics:  $PRR \leq 10\text{ MHz}$ ,  $Z_O = 50\ \Omega$ ,  $t_r \leq 2\text{ ns}$ ,  $t_f \leq 2\text{ ns}$ .  
D. The outputs are measured one at a time, with one transition per measurement.  
E.  $t_{PLZ}$  and  $t_{PHZ}$  are the same as  $t_{dis}$ .  
F.  $t_{PZL}$  and  $t_{PZH}$  are the same as  $t_{en}$ .  
G.  $t_{PLH}$  and  $t_{PHL}$  are the same as  $t_{pd}$ .

**Figure 2. Load Circuit and Voltage Waveforms**



PARAMETER MEASUREMENT INFORMATION

$V_{CC} = 2.7\text{ V}$  AND  $3.3\text{ V} \pm 0.3\text{ V}$

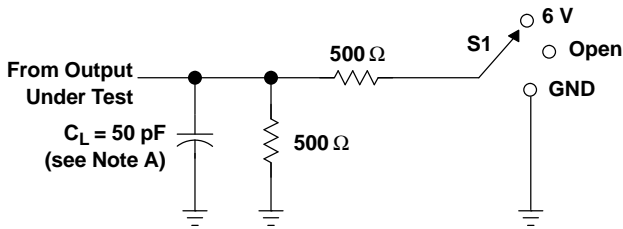

LOAD CIRCUIT

TEST	S1
$t_{pd}$	Open
$t_{PLZ}/t_{PZL}$	6 V
$t_{PHZ}/t_{PZH}$	GND

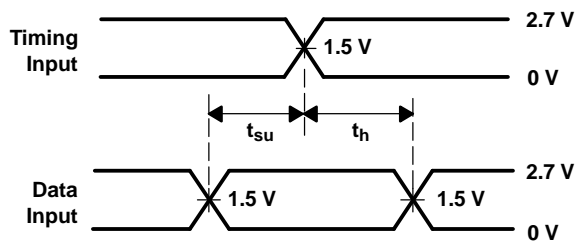

VOLTAGE WAVEFORMS  
SETUP AND HOLD TIMES

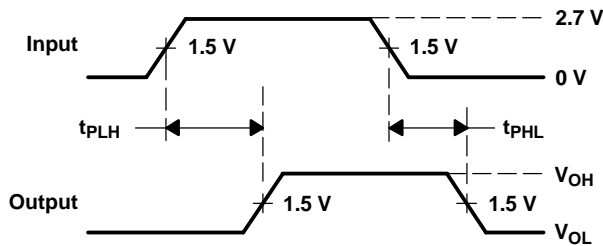

VOLTAGE WAVEFORMS  
PROPAGATION DELAY TIMES

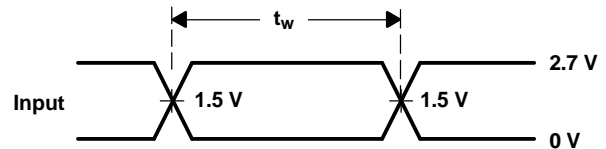

VOLTAGE WAVEFORMS  
PULSE DURATION

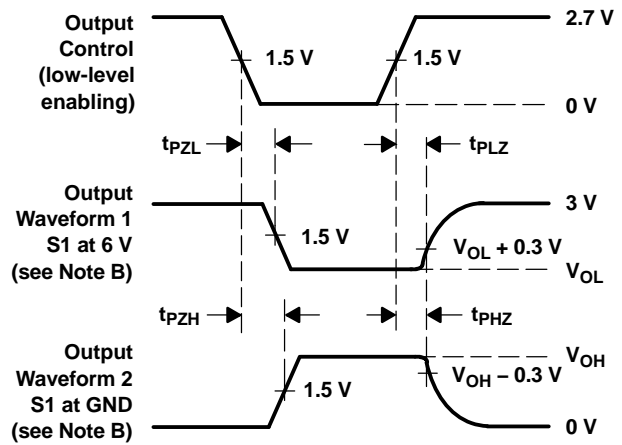

VOLTAGE WAVEFORMS  
ENABLE AND DISABLE TIMES

- NOTES:
- $C_L$  includes probe and jig capacitance.
  - Waveform 1 is for an output with internal conditions such that the output is low, except when disabled by the output control. Waveform 2 is for an output with internal conditions such that the output is high, except when disabled by the output control.
  - All input pulses are supplied by generators having the following characteristics:  $PRR \leq 10\text{ MHz}$ ,  $Z_O = 50\ \Omega$ ,  $t_r \leq 2.5\text{ ns}$ ,  $t_f \leq 2.5\text{ ns}$ .
  - The outputs are measured one at a time, with one transition per measurement.
  - $t_{PLZ}$  and  $t_{PHZ}$  are the same as  $t_{dis}$ .
  - $t_{PZL}$  and  $t_{PZH}$  are the same as  $t_{en}$ .
  - $t_{PLH}$  and  $t_{PHL}$  are the same as  $t_{pd}$ .

Figure 3. Load Circuit and Voltage Waveforms

**PACKAGING INFORMATION**

Orderable Device	Status <sup>(1)</sup>	Package Type	Package Drawing	Pins	Package Qty	Eco Plan <sup>(2)</sup>	Lead/Ball Finish	MSL Peak Temp <sup>(3)</sup>
74ALVCH16334DGGRE4	ACTIVE	TSSOP	DGG	48	2000	Green (RoHS & no Sb/Br)	CU NIPDAU	Level-1-260C-UNLIM
74ALVCH16334DGGRG4	ACTIVE	TSSOP	DGG	48	2000	Green (RoHS & no Sb/Br)	CU NIPDAU	Level-1-260C-UNLIM
74ALVCH16334DGVRE4	ACTIVE	TVSOP	DGV	48	2000	Green (RoHS & no Sb/Br)	CU NIPDAU	Level-1-260C-UNLIM
74ALVCH16334DGVRG4	ACTIVE	TVSOP	DGV	48	2000	Green (RoHS & no Sb/Br)	CU NIPDAU	Level-1-260C-UNLIM
74ALVCH16334DLG4	ACTIVE	SSOP	DL	48	25	Green (RoHS & no Sb/Br)	CU NIPDAU	Level-1-260C-UNLIM
SN74ALVCH16334DGGR	ACTIVE	TSSOP	DGG	48	2000	Green (RoHS & no Sb/Br)	CU NIPDAU	Level-1-260C-UNLIM
SN74ALVCH16334DGVR	ACTIVE	TVSOP	DGV	48	2000	Green (RoHS & no Sb/Br)	CU NIPDAU	Level-1-260C-UNLIM
SN74ALVCH16334DL	ACTIVE	SSOP	DL	48	25	Green (RoHS & no Sb/Br)	CU NIPDAU	Level-1-260C-UNLIM

<sup>(1)</sup> The marketing status values are defined as follows:

**ACTIVE:** Product device recommended for new designs.

**LIFEBUY:** TI has announced that the device will be discontinued, and a lifetime-buy period is in effect.

**NRND:** Not recommended for new designs. Device is in production to support existing customers, but TI does not recommend using this part in a new design.

**PREVIEW:** Device has been announced but is not in production. Samples may or may not be available.

**OBSELETE:** TI has discontinued the production of the device.

<sup>(2)</sup> Eco Plan - The planned eco-friendly classification: Pb-Free (RoHS), Pb-Free (RoHS Exempt), or Green (RoHS & no Sb/Br) - please check <http://www.ti.com/productcontent> for the latest availability information and additional product content details.

**TBD:** The Pb-Free/Green conversion plan has not been defined.

**Pb-Free (RoHS):** TI's terms "Lead-Free" or "Pb-Free" mean semiconductor products that are compatible with the current RoHS requirements for all 6 substances, including the requirement that lead not exceed 0.1% by weight in homogeneous materials. Where designed to be soldered at high temperatures, TI Pb-Free products are suitable for use in specified lead-free processes.

**Pb-Free (RoHS Exempt):** This component has a RoHS exemption for either 1) lead-based flip-chip solder bumps used between the die and package, or 2) lead-based die adhesive used between the die and leadframe. The component is otherwise considered Pb-Free (RoHS compatible) as defined above.

**Green (RoHS & no Sb/Br):** TI defines "Green" to mean Pb-Free (RoHS compatible), and free of Bromine (Br) and Antimony (Sb) based flame retardants (Br or Sb do not exceed 0.1% by weight in homogeneous material)

<sup>(3)</sup> MSL, Peak Temp. -- The Moisture Sensitivity Level rating according to the JEDEC industry standard classifications, and peak solder temperature.

**Important Information and Disclaimer:**The information provided on this page represents TI's knowledge and belief as of the date that it is provided. TI bases its knowledge and belief on information provided by third parties, and makes no representation or warranty as to the accuracy of such information. Efforts are underway to better integrate information from third parties. TI has taken and continues to take reasonable steps to provide representative and accurate information but may not have conducted destructive testing or chemical analysis on incoming materials and chemicals. TI and TI suppliers consider certain information to be proprietary, and thus CAS numbers and other limited information may not be available for release.

In no event shall TI's liability arising out of such information exceed the total purchase price of the TI part(s) at issue in this document sold by TI to Customer on an annual basis.

## TAPE AND REEL INFORMATION



### QUADRANT ASSIGNMENTS FOR PIN 1 ORIENTATION IN TAPE



\*All dimensions are nominal

Device	Package Type	Package Drawing	Pins	SPQ	Reel Diameter (mm)	Reel Width W1 (mm)	A0 (mm)	B0 (mm)	K0 (mm)	P1 (mm)	W (mm)	Pin1 Quadrant
SN74ALVCH16334DGGR	TSSOP	DGG	48	2000	330.0	24.4	8.6	15.8	1.8	12.0	24.0	Q1
SN74ALVCH16334DGVR	TVSOP	DGV	48	2000	330.0	16.4	7.1	10.2	1.6	12.0	16.0	Q1

**TAPE AND REEL BOX DIMENSIONS**

\*All dimensions are nominal

Device	Package Type	Package Drawing	Pins	SPQ	Length (mm)	Width (mm)	Height (mm)
SN74ALVCH16334DGGR	TSSOP	DGG	48	2000	346.0	346.0	41.0
SN74ALVCH16334DGVR	TVSOP	DGV	48	2000	346.0	346.0	33.0

DL (R-PDSO-G\*\*)

PLASTIC SMALL-OUTLINE PACKAGE

48 PINS SHOWN



- NOTES: A. All linear dimensions are in inches (millimeters).  
 B. This drawing is subject to change without notice.  
 C. Body dimensions do not include mold flash or protrusion not to exceed 0.006 (0,15).  
 D. Falls within JEDEC MO-118

DGG (R-PDSO-G\*\*)

PLASTIC SMALL-OUTLINE PACKAGE

48 PINS SHOWN



- NOTES: A. All linear dimensions are in millimeters.  
 B. This drawing is subject to change without notice.  
 C. Body dimensions do not include mold protrusion not to exceed 0,15.  
 D. Falls within JEDEC MO-153

DGV (R-PDSO-G\*\*)

PLASTIC SMALL-OUTLINE

24 PINS SHOWN



4073251/E 08/00

- NOTES: A. All linear dimensions are in millimeters.  
 B. This drawing is subject to change without notice.  
 C. Body dimensions do not include mold flash or protrusion, not to exceed 0,15 per side.  
 D. Falls within JEDEC: 24/48 Pins – MO-153  
 14/16/20/56 Pins – MO-194

## IMPORTANT NOTICE

Texas Instruments Incorporated and its subsidiaries (TI) reserve the right to make corrections, modifications, enhancements, improvements, and other changes to its products and services at any time and to discontinue any product or service without notice. Customers should obtain the latest relevant information before placing orders and should verify that such information is current and complete. All products are sold subject to TI's terms and conditions of sale supplied at the time of order acknowledgment.

TI warrants performance of its hardware products to the specifications applicable at the time of sale in accordance with TI's standard warranty. Testing and other quality control techniques are used to the extent TI deems necessary to support this warranty. Except where mandated by government requirements, testing of all parameters of each product is not necessarily performed.

TI assumes no liability for applications assistance or customer product design. Customers are responsible for their products and applications using TI components. To minimize the risks associated with customer products and applications, customers should provide adequate design and operating safeguards.

TI does not warrant or represent that any license, either express or implied, is granted under any TI patent right, copyright, mask work right, or other TI intellectual property right relating to any combination, machine, or process in which TI products or services are used. Information published by TI regarding third-party products or services does not constitute a license from TI to use such products or services or a warranty or endorsement thereof. Use of such information may require a license from a third party under the patents or other intellectual property of the third party, or a license from TI under the patents or other intellectual property of TI.

Reproduction of TI information in TI data books or data sheets is permissible only if reproduction is without alteration and is accompanied by all associated warranties, conditions, limitations, and notices. Reproduction of this information with alteration is an unfair and deceptive business practice. TI is not responsible or liable for such altered documentation. Information of third parties may be subject to additional restrictions.

Resale of TI products or services with statements different from or beyond the parameters stated by TI for that product or service voids all express and any implied warranties for the associated TI product or service and is an unfair and deceptive business practice. TI is not responsible or liable for any such statements.

TI products are not authorized for use in safety-critical applications (such as life support) where a failure of the TI product would reasonably be expected to cause severe personal injury or death, unless officers of the parties have executed an agreement specifically governing such use. Buyers represent that they have all necessary expertise in the safety and regulatory ramifications of their applications, and acknowledge and agree that they are solely responsible for all legal, regulatory and safety-related requirements concerning their products and any use of TI products in such safety-critical applications, notwithstanding any applications-related information or support that may be provided by TI. Further, Buyers must fully indemnify TI and its representatives against any damages arising out of the use of TI products in such safety-critical applications.

TI products are neither designed nor intended for use in military/aerospace applications or environments unless the TI products are specifically designated by TI as military-grade or "enhanced plastic." Only products designated by TI as military-grade meet military specifications. Buyers acknowledge and agree that any such use of TI products which TI has not designated as military-grade is solely at the Buyer's risk, and that they are solely responsible for compliance with all legal and regulatory requirements in connection with such use.

TI products are neither designed nor intended for use in automotive applications or environments unless the specific TI products are designated by TI as compliant with ISO/TS 16949 requirements. Buyers acknowledge and agree that, if they use any non-designated products in automotive applications, TI will not be responsible for any failure to meet such requirements.

Following are URLs where you can obtain information on other Texas Instruments products and application solutions:

### Products

Amplifiers	<a href="http://amplifier.ti.com">amplifier.ti.com</a>
Data Converters	<a href="http://dataconverter.ti.com">dataconverter.ti.com</a>
DLP® Products	<a href="http://www.dlp.com">www.dlp.com</a>
DSP	<a href="http://dsp.ti.com">dsp.ti.com</a>
Clocks and Timers	<a href="http://www.ti.com/clocks">www.ti.com/clocks</a>
Interface	<a href="http://interface.ti.com">interface.ti.com</a>
Logic	<a href="http://logic.ti.com">logic.ti.com</a>
Power Mgmt	<a href="http://power.ti.com">power.ti.com</a>
Microcontrollers	<a href="http://microcontroller.ti.com">microcontroller.ti.com</a>
RFID	<a href="http://www.ti-rfid.com">www.ti-rfid.com</a>
RF/IF and ZigBee® Solutions	<a href="http://www.ti.com/lprf">www.ti.com/lprf</a>

### Applications

Audio	<a href="http://www.ti.com/audio">www.ti.com/audio</a>
Automotive	<a href="http://www.ti.com/automotive">www.ti.com/automotive</a>
Broadband	<a href="http://www.ti.com/broadband">www.ti.com/broadband</a>
Digital Control	<a href="http://www.ti.com/digitalcontrol">www.ti.com/digitalcontrol</a>
Medical	<a href="http://www.ti.com/medical">www.ti.com/medical</a>
Military	<a href="http://www.ti.com/military">www.ti.com/military</a>
Optical Networking	<a href="http://www.ti.com/opticalnetwork">www.ti.com/opticalnetwork</a>
Security	<a href="http://www.ti.com/security">www.ti.com/security</a>
Telephony	<a href="http://www.ti.com/telephony">www.ti.com/telephony</a>
Video & Imaging	<a href="http://www.ti.com/video">www.ti.com/video</a>
Wireless	<a href="http://www.ti.com/wireless">www.ti.com/wireless</a>

Mailing Address: Texas Instruments, Post Office Box 655303, Dallas, Texas 75265  
Copyright © 2009, Texas Instruments Incorporated